



# Hall® Powered Instruments System™

Product Catalog



**MICROPOWER®**  
SAW



**MICRO 100®**  
SURGAIPTOME

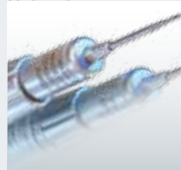

**M-CLASS®**  
BLADES

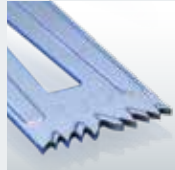

**HALL® LITHIUM**  
BATTERIES



**HALL®**  
POWERED INSTRUMENTS

Ordering Information .....	2
Product Support .....	3
Product Support & Service Programs.....	4
Return/Repair Information .....	5
Batteries & Accessories .....	6, 7
Electric Consoles & Accessories .....	8, 9
Pneumatic Regulators, Hoses & Accessories.....	10
MPower® 2 Indications for Use: Large Bone & Small Bone Orthopaedics.....	11
PowerPro® & PowerPro Electric II™ Indications for Use: Large Bone & Small Bone Orthopaedics .....	12
PowerPro Pneumatic Indications for Use: Large Bone & Small Bone Orthopaedics .....	13
MPower 2, MPower, PowerPro Electric II & PowerPro Pneumatic Attachments .....	14
MicroPower® & Micro 100™ Attachments & Bur Guards .....	15
MicroPower Indications for Use: Small Bone.....	16
Micro 100 Indications for Use: Small Bone.....	17
E9000® System Indications for Use: ENT, Spine & Neuro .....	18
Ultrapower® Indications for Use: Spine & Neuro .....	19
Osteon™ Indications for use: ENT.....	20
Sternum Saws.....	21
Cebotome® Indications for use: Large Bone Revision Surgery .....	22
Staplizer® Small Bone Fixation System .....	23
Miscellaneous Accessories.....	24
Kit Listings .....	25 - 28
M-Class® Blades .....	29
Hall® Classic Blades .....	30
Intrex® Blade System .....	31
Large Bone Knee Blades Indication for Use: Total Knee Arthroplasty .....	32 - 41
Large Bone Oscillating Blades ACL Blades .....	42
Large Bone Oscillating Blades Indications for Use: Total Hip Arthroplasty & Large Bone Trauma .....	43 - 46
Large Bone Reciprocating Blades Indications for Use: Total Joint Arthroplasty & Large Bone Trauma.....	47, 48
MicroPower & Micro 100 Sagittal Saw Blades Indications for Use: Small Bone .....	49 - 51
MicroPower & Micro 100 Oscillating Saw Blades Indications for Use: Small Bone .....	52
MicroPower & Micro 100 Reciprocating Saw Blades & Rasps Indications for Use: Small Bone.....	53
MicroPower & Micro 100 Small Bone Burs Indications for Use: Small Bone .....	54 - 56
Wires & Staples Indication for Use: Small Bone Trauma.....	57
E9005 ENT Shaver Blades Indications for Use: Sinus Surgery.....	58 - 61
E Burs Indications for Use: Otolary, Spine & Neuro.....	62, 63
UltraPower Burs Indications for Use: Otolary (Round Burs Only), Spine & Neuro .....	64 - 68
Osteon Burs Indications for use: Otolary.....	69
Cebotome Burs & Metal Cutting Accessories Indication for Use: Large Bone Revisions Surgery.....	70
Sternum Saw Blades Indications for Use: Primary & Repeat Sternotomy .....	71, 72
Numerical Index.....	74 - 93
Alphabetical Index.....	94 - 113

## Terms

ConMed standard terms are net thirty (30) days, F.O.B. shipping point, unless otherwise approved in writing by ConMed. All orders and transactions are subject to the laws of the state of Florida.

## To Place Your Order

Please provide a purchase order number, billing and shipping instructions, product catalog number and description, valid ConMed quotation, and quantity and pricing to one of the following:

## Your Sales Representative

### Customer Service

Phone: 800-237-0169

Fax: 727-399-5256

E-mail: [custserv1@conmed.com](mailto:custserv1@conmed.com)

### ConMed

Attn: Customer Service

11311 Concept Boulevard

Largo, FL 33773-4908 USA

## True Purchasing Flexibility

ConMed Financial Services offers a variety of flexible financing programs, from leases to Pre-Procedure Programs to delayed payment plans. Ask your Sales Representative for more information on how you can acquire the latest technology through a financing program that fits your unique budgetary requirements.

## Rental Program for Instrument Sets & Capital Equipment

In every O.R., there are times when you have to schedule a case but do not have the equipment needed. Either the capital funding for the equipment has yet to be approved or you have been unable to justify the cost of the equipment due to the procedure's low volume.

For these situations, ConMed offers a rental program for procedure-specific instruments and capital equipment. Simply call ConMed at 888-587-9742 and everything that you need for the case is on its way.

To enroll in a rental program, contact your Sales Representative or call the ConMed field inventory team. Your representative will help you customize the kit(s) to fit your procedural requirements. After the case, simply return the instruments, cleaned and sterilized if appropriate, along with any disposables you did not use. The rental fee will be billed for the disposables not returned, and customer will be responsible for any expedited shipping cost.

Failure to return instrumentation/equipment at the end of the rental period will result in the customer being charged the standard rental fee automatically for each week that the instrumentation/equipment is not received by ConMed.

At ConMed, we want to offer more than a quality product. We take pride in being able to provide you with value added services to support our products. The information given in this catalog is designed to address your questions regarding product support.

## Customer Support

If you encounter a problem or need technical assistance, contact Customer Service (Product Support) or your Sales Representative. Refer to the Customer Service telephone numbers listed.

## Regulatory Compliance

Report any injuries or malfunctions to ConMed Customer Service. Refer to the Customer Service telephone numbers listed.

## Original Warranty

ConMed (the “Company”) warrants to the first purchaser or lessee (“You” or “Customer”) that the instruments, attachments and parts manufactured by or for the Company (hereinafter collectively “Instruments”) have been tested, inspected, and shipped in proper working order.

The Company warrants all new instruments to be free from defects in materials and workmanship for the following periods, measured from date of sale\*:

<b>Product Categories</b>	<b>Months</b>
All Single Use Products.....	Upon Receipt
MPower® and MPower 2 Handpieces.....	12
Powered Surgical Instruments.....	12
Power Attachments and Accessories.....	12
Handpiece Cords and Power Cords.....	6
Pneumatic Hoses.....	6
Bur Guards, Blade Guards, Attachments.....	6
Battery Packs and Accessories.....	3
Battery Chargers.....	12
Camera Consoles.....	12
Video Components.....	12
Video Cables and Light Guides.....	3
Scopes.....	12
Camera Heads.....	12
Instruments.....	12
Instrument Tray.....	3
Footswitches.....	12
Irrigation Systems (Pumps and Remotes).....	12
Reusable Procedure Specific Instruments.....	6

Following the Original Warranty, ConMed offers additional warranty and service programs that support our products throughout their lifetime. Service programs address the necessity to control cost and greatly reduce repair turnaround time by eliminating the need for repair quotes. Products not covered under a service program are subject to variable repair charges. To find out which service option best meets your needs, contact your local Sales Representative.

## Service Agreements

Service Agreements provide additional service coverage on capital equipment. This additional warranty period covers all repair costs, periodic maintenance, free loaner usage during repair time and freight charges out from ConMed both on the loaner product and the repaired instrument.

## Service Warranty

After expiration of the Original or Service Agreement period, instruments may be returned to ConMed for repair at the customer’s expense. ConMed warrants that any service or repair work performed by ConMed shall be free from defects in workmanship and materials for a period of 90 days after the date the customer receives the Instrument(s). This limited warranty applies only to the actual service or repair work performed by ConMed or its authorized service centers. ConMed warrants that all parts and assemblies used in the repair or service of Instruments meet new part functional specifications, although some parts or assemblies may have been remanufactured.

ConMed components are manufactured to exacting tolerances and design specifications. As a standard practice, all repairs are subject to strict product performance and testing specifications prior to returning the Instrument to the customer. ConMed ensures that each Instrument is inspected according to the guidelines used for new manufactured Instruments. If an Instrument is determined unrepairable, ConMed will offer to sell to the customer a refurbished or brand new Instrument or comparable equivalent at a preferential price. All parts and assemblies replaced by ConMed shall become the property of ConMed.

## Repair Quotes

Upon request Customer Service can estimate the repair charges for non-warranty repairs. If a firm repair quote is requested, please return your product for inspection and you will be contacted before the repair is initiated. If a product is returned and a firm quote is not requested, the repair will be processed and your account billed accordingly.

## Minimum Service Charge

There is a minimum repair charge for the evaluation and testing of all returns (except for products covered under warranty).

## Return Shipping

All repaired products will be returned to you via second day air delivery unless you request an alternate shipping method. The cost of return shipping is your responsibility unless the product is under warranty or service agreement.

\* Effective February 1, 2014

## Warranty Terms

If the customer discovers within the warranty period (Original or Service Agreement) that an Instrument has a defect in materials and/or workmanship, the customer must promptly notify the Company. Also, if the customer discovers within the service warranty period that any service or repair work performed by ConMed has a defect in workmanship and/or materials, the customer must promptly notify the Company. If it becomes necessary to return the Instrument to the Company, the customer must (a) acquire a "Service Request" (SR) authorization from the Company Customer Service Department, (b) pack the unit carefully, and (c) return it to the Company.

Within a reasonable time after receipt of the Instrument, the Company will investigate and correct any defect covered by warranty by providing, at its option, one of the following: service or repair of the Instrument, or replacement of the Instrument. All parts and assemblies replaced by ConMed shall become the property of ConMed. These remedies are the customer's exclusive remedies under the warranty.

### The foregoing limited warranties do not apply to:

- » Instruments that have been tampered with, altered, neglected, or misused,
- » Instruments damaged through use with other than Company authorized accessories, attachments, burs or blades,
- » Instruments not manufactured by or for the Company,
- » Instruments used for purposes other than those for which they were designed and manufactured, including use in any way inconsistent with the instructions and warnings contained in the Company instruction manuals and package inserts, and
- » Instruments that were last serviced, refurbished, reprocessed or reconditioned by a nonauthorized service entity.

**THE FOREGOING LIMITED WARRANTIES ARE IN LIEU OF ALL OTHER WARRANTIES, EXPRESS OR IMPLIED, INCLUDING, BUT NOT LIMITED TO, THE IMPLIED WARRANTIES OF MERCHANTABILITY AND FITNESS FOR A PARTICULAR PURPOSE.**

In no case shall the Company be liable for any special, incidental, indirect or consequential damages based upon breach of warranty or any other legal theory. Some jurisdictions do not allow limits on warranties, or on remedies, and, in such jurisdictions, the limits in this and the preceding paragraphs may not apply.

The Company reserves the right (a) to make design changes to Instruments at any time without notice to customer and without incurring any obligation to incorporate those changes into Instruments previously purchased or leased, and (b) to make changes from time to time in the contents of any publication, instruction manual or package insert without any obligation to notify customers of such revisions or changes, and (c) to change price without notice.

## U.S. Procedure for Returns/Repairs

1. All Instruments must be cleaned and sterilized, if appropriate, prior to return of any Instrument to ConMed. Instruments contaminated with biohazardous materials will be returned to you at your expense.
2. An authorized Service Request (SR) Number must be obtained prior to returning any Instrument for repair/return.
3. To return a product for repair, contact ConMed Customer Service. The following information is needed to process a repair/return:
  - » Catalog Number
  - » Serial/Lot Number
  - » Original Invoice Number
  - » Detailed description of the problem or reason for return
4. The SR number must be displayed on the outside of the box, included with all paperwork, and must be referred to when making an inquiry about the status of a repair/return.
5. ConMed maintains various repair centers around the world. When you are issued your SR number, you will be advised of the location where to send your product.

## Return Terms

If it becomes necessary to return a product after purchase, the product must be returned within 45 days of its ship date. The product must be returned unused, in the original packaging and be restockable. Returns must be shipped prepaid freight. Returns that are not shipped prepaid freight will not be accepted. All product returns, except those attributable to a ConMed error, are subject to a restocking fee of 15% of the purchase price or \$25, whichever is greater.

### Products Not Eligible for Credit:

- » Sterile products/single use devices returned with the outer packaging seals broken
- » Non-sterile products that have been sterilized and/or placed in the surgical field
- » Products damaged by customer misuse or negligence
- » Altered or customized products
- » Products damaged in return transit due to inadequate packaging
- » Less than full packages – all products must be in original packaging
- » Obsolete products

### Packaging

Whenever it is required to return your product, be sure to package it in a protective carton. We recommend that you save the original shipping container for this purpose. In-transit damage is not covered by the warranty; therefore, it is best to always insure shipments.



**L3000**



**L3000LG**



**PRO3600**



**PRO3020**



**PRO3010**



**PRO3011**

Hall® Lithium Charger ..... **Cat. No.** L3000

Hall Lithium Battery, 13.2 Volt..... L3000LG

Battery Charger ..... PRO3600

Small NiCad Battery, 12 Volt ..... PRO3020

Large NiCad Battery, 9.6 Volt..... PRO3010

X-Large NiCad Battery, 12 Volt..... PRO3011

	Cat. No.
Small NiMH Sterile Transfer Battery, 12 Volt .....	PRO3520
Large NiMH Sterile Transfer Battery, 9.6 Volt.....	PRO3115

Battery Case for PRO3520 .....	PRO3521
Battery Case for PRO3115.....	PRO3110

Transfer Shroud for PRO3521 .....	PRO3531
Transfer Shroud for PRO3110 .....	PRO3130

Charging Platform for PRO3520.....	PRO3535
Charging Platform for PRO3115 .....	PRO3135



**PRO3520**



**PRO3115**



**PRO3521**



**PRO3110**



**PRO3531**



**PRO3130**



**PRO3535**



**PRO3135**

All products may not be available in all markets.



# Electric Consoles & Accessories



**D4000**



**D3000**



**E9000**



**PRO2000**

Cat. No.

D4000 Console ..... D4000

Advantage® Console ..... D3000

E9000® Console ..... E9000

PowerPro® Console ..... PRO2000

2-Pedal Footswitch.....Cat. No. 5020-053



**5020-053**

3-Pedal Footswitch.....C9863



**C9863**

Handpiece Cord.....MC5057



**MC5057**

AC Power Cord.....5039-003



**5039-003**

Fluid Bag Support Rod for D3000 & E9000 ..... 5040-180



**5040-180**

Console Stand.....5020-054



**5020-054**

All products may not be available in all markets.

# Pneumatic Regulators, Hoses & Accessories



1375-028



Universal Hose



Extension Hose



Hose for Staplizer®

Hall® offers nitrogen specific products. Please contact customer service for information.

Cat. No.

Micro 100™ Footswitch.....	1375-028
Universal Hose, 10' (3.05m) for Hall Handpieces .....	5052-010

Extension Hose, 10' (3.05m), Male Schrader to Female Schrader.....	5052-018
Extension Hose, 10' (3.05m), Male Diss and Female Schrader .....	5052-029
10' (3.05m) Hose for Staplizer® Handpiece .....	A201

Regulator, Single Connection.....	M207
Regulator, Dual Connection .....	M208



M207



M208

DISS to Schrader Adapter.....	M322
Schrader Coupler.....	5144-002



M322



5144-002

Y Connector .....	1375-040
Blitz® Instrument Cleaner (Use with Staplizer Handpiece) .....	M105A



1375-040



M105A

Instrument Lubricant for Staplizer.....	M317
Hall Lubricant for Angled Attachments.....	1365-016
Hall Lubricant for Surgical Angled Attachments .....	1375-037



M317



1365-016



1375-037

All products may not be available in all markets.

*Attachments Listed on Page 14*

	Cat. No.
Single Trigger Modular Handpiece .....	PRO6200M
2-Trigger Modular Handpiece .....	PRO6202M

Oscillating Saw .....	PRO6350M
Reciprocating Saw .....	PRO6400M

Wire Driver for PRO6200 .....	PRO6128
Range: 0.7 – 1.6mm (0.028 – 0.062")	
Pin Driver for PRO6200 .....	PRO6140
Range: 1.8 – 4.0mm (0.071 – 0.157")	

Wire Driver for PRO6202 .....	PRO6228
Range: 0.7 – 1.6mm (0.028 – 0.062")	
Pin Driver for PRO6202 .....	PRO6240
Range: 1.8 – 4.0mm (0.071 – 0.157")	



**PRO6200M**



**PRO6202M**



**PRO6350M**



**PRO6400M**



**PRO6128**



**PRO6140**



**PRO6228**



**PRO6240**

All products may not be available in all markets.

# PowerPro® & PowerPro Electric II™

Indications for Use: Large Bone  
& Small Bone Orthopaedics



**PRO6100**



**PRO6125**



**PRO6135**



**PRO6128**



**PRO6140**

*Attachments Listed on Page 14*

**Cat. No.**

Single Trigger Modular Handpiece ..... PRO6100

Oscillating Saw ..... PRO6125

Reciprocating Saw ..... PRO6135

Wire Driver for PRO6100 ..... PRO6128  
Range: 0.7 – 1.6mm (0.028 – 0.062")

Pin Driver for PRO6100 ..... PRO6140  
Range: 1.8 – 4.0mm (0.071 – 0.157")

Attachments Listed on Page 14

Single Trigger Modular Handpiece ..... **Cat. No.** PRO6150

Oscillating Saw ..... PRO6175

Reciprocating Saw ..... PRO6185

Wire Driver for PRO6150 ..... PRO6128  
Range: 0.7 – 1.6mm (0.028 – 0.062")

Pin Driver for PRO6150 ..... PRO6140  
Range: 1.8 – 4.0mm (0.071 – 0.157")



**PRO6150**



**PRO6175**



**PRO6185**



**PRO6128**



**PRO6140**

All products may not be available in all markets.

# Mpower<sup>®</sup> 2, MPower, PowerPro Electric II™ & PowerPro Pneumatic Attachments



## Drill-Ream 1:1/5:1 Combination Attachments



Drill-Ream Attachment, AO  
Cat. No. .... **PRO1540**



Drill-Ream Attachment, 1/4" (6.35mm) Chuck  
Cat. No. .... **PRO1541**



Drill-Ream Attachment, Zimmer/Hudson  
Cat. No. .... **PRO1547**



Drill-Ream Attachment, DePuy/Hudson  
Cat. No. .... **PRO1545**

## 1:1 Multipurpose Attachments



1/8" (4.0mm) Jacobs Chuck, with Chuck Key  
Cat. No. .... **PRO2030**



1/8" (4.0mm) Replacement Chuck Key  
Cat. No. .... **5044-999-53**



1/4" (6.35mm) Jacobs Chuck  
Cat. No. .... **PRO2041**



1/4" (6.35mm) Replacement Chuck Key  
Cat. No. .... **5044-999-52**



1/4" Keyless Chuck  
Cat. No. .... **PRO6050**



1/4" Keyless Chuck  
Cat. No. .... **PRO2250**

## 1:1 Quick Connect Drill Attachments



AO/Trinkle  
Cat. No. .... **PRO2029**



Small AO—Low Profile  
Cat. No. .... **PRO2038**



Small AO—One Handed Operation  
Cat. No. .... **PRO2138**



Zimmer/Hudson  
Cat. No. .... **PRO2046**



Large AO  
Cat. No. .... **PRO2070**



Standard Hudson (DePuy)  
Cat. No. .... **PRO2075**



Mini AO  
Cat. No. .... **PRO2039**

## 3:1 Reamers



3:1 1/4" High Torque Jacobs Chuck  
Cat. No. .... **PRO2042**



3:1 Zimmer/Hudson Reamer  
Cat. No. .... **PRO2047**



3:1 Hudson Reamer (DePuy)  
Cat. No. .... **PRO2065**



3:1 Large AO Reamer  
Cat. No. .... **PRO2040**



3:1 Aesculap Reamer  
Cat. No. .... **PRO2060**



3:1 DHS Reamer  
Cat. No. .... **PRO2080**



3:1 Trinkle Reamer  
Cat. No. .... **PRO2329**

## 5:1 Reamers



5:1 1/4" High Torque Jacobs Chuck  
Cat. No. .... **PRO6042**



5:1 Zimmer/Hudson Reamer  
Cat. No. .... **PRO6047**



5:1 Hudson Reamer(DePuy)  
Cat. No. .... **PRO6048**



5:1 Large AO Reamer  
Cat. No. .... **PRO6040**



5:1 Aesculap Reamer  
Cat. No. .... **PRO6060**

## Miscellaneous Attachments



Radiolucent Drive Adaptor  
Cat. No. .... **PRO2514**



High Speed Drill Attachment  
Cat. No. .... **PRO2033**



Sagittal Saw Attachment  
Cat. No. .... **PRO2043**



Multipurpose High Speed  
Cat. No. .... **PRO7020**



Reciprocating Saw Attachment for PRO6100, PRO6150, PRO6200M, & PRO6202M  
Cat. No. .... **PRO6045**

## Attachments

	Cat. No.
Medium Bur Guard .....	1375-012
Long Bur Guard.....	1375-011
X-Long Bur Guard.....	1375-023
Laminectomy Guard.....	1375-020
Use 5092-103/203 long carbide burs, the laminectomy burs are the only burs that can be inserted prior to placing bur guard.	
Rhinoplasty Guard .....	1375-021
Tissue Retractor .....	1387-022
Use only with long burs (5092 series) which have diameter of 4.0mm or less. Recommended burs 5092-136.	
20 degree Angled Attachment .....	1375-032
Use only 5092 series X-long burs.	
20 degree X-Long Angled Attachment.....	1375-033
Use only 5093 series X-long burs.	
70 degree Contra Angle with Dental Head.....	1375-034
Use friction grip burs only – size .0625" or 1.58mm diameter. Not available from ConMed.	
70 degree Contra Angle with Surgical Head .....	1375-035
Use only 5089 ultra-short burs and 5090 series short burs.	
90 degree Angled Attachment .....	1375-036
Use only 5089 X-short burs and 5090 series short burs.	
Bur Changer for 70 and 90 degree Angled Attachments .....	1375-003
Irrigation Tubing Set.....	E9418

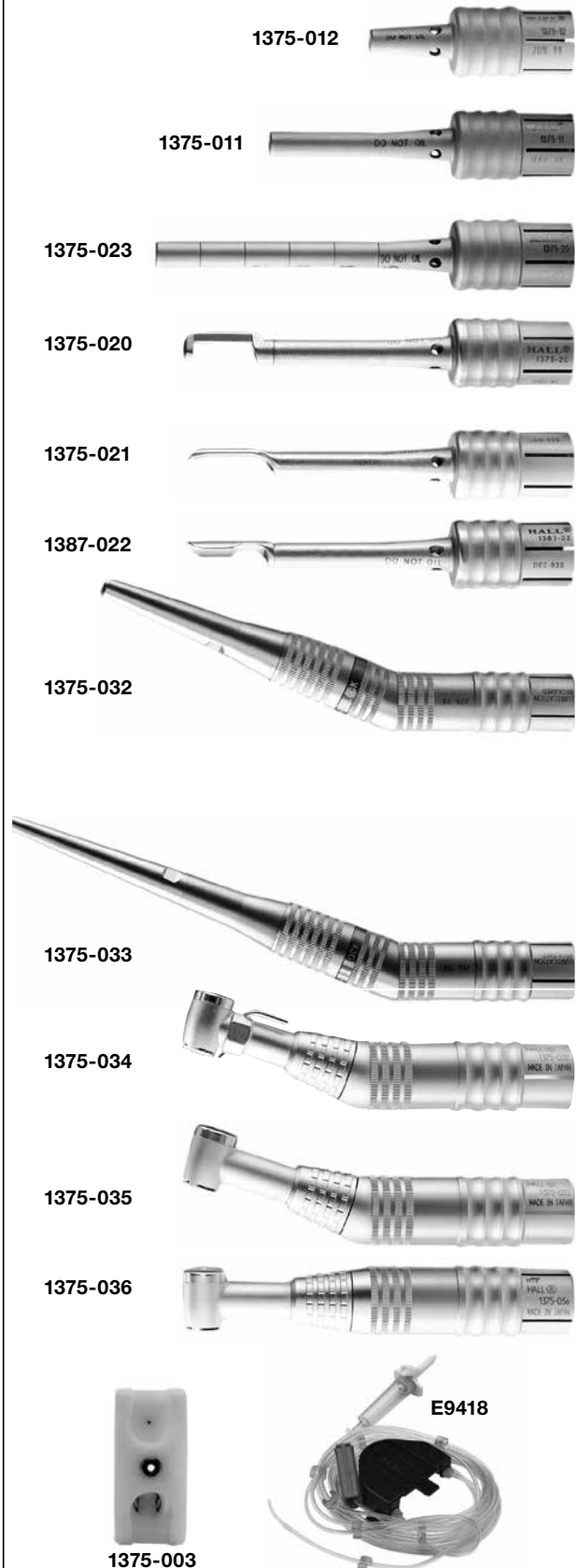

All products may not be available in all markets.



Attachments on page 15

## Handpieces

Removable Lever

Permanently Attached Lever

Oral Max High Speed Drill.....6020-025 .....6021-025

Orthopedic High Speed Drill.....6020-026 .....6021-026

Medium Speed Drill .....6020-021 .....6021-021

Sagittal Saw .....6020-022 .....6021-022

Reciprocating Saw.....6020-023 .....6021-023

Oscillating Saw.....6020-024 .....6021-024



**Oral Max High Speed Drill**



**Orthopedic High Speed Drill**

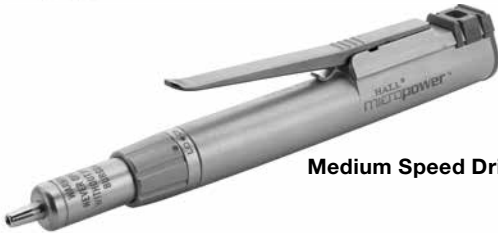

**Medium Speed Drill**



**Sagittal Saw**

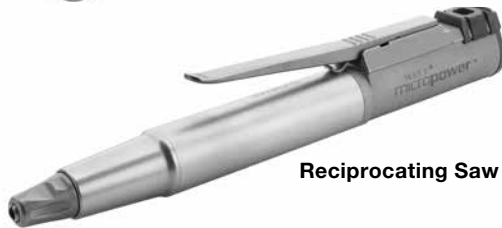

**Reciprocating Saw**



**Oscillating Saw**

Attachments on Page 15

### Handpieces

	Cat. No.
Surgairtome Two® High Speed Drill Kit (System listing on page 25).....	5058-000
Surgairtome Two High Speed Drill .....	5058-001
Medium Speed Drill .....	5053-009
Reciprocating Saw .....	5053-010
Sagittal Saw .....	5053-011
Oscillating Saw .....	5053-012
XL Oscillating Saw .....	5053-022
Wire Driver .....	5053-013
Throttle Clip (for lever) Used during footswitch operation.....	5053-074

### Attachments & Accessories

Wire Guard for use with 5053-013 .....	5053-123
Wire Driver Adapter Chuck for use with 5053-013 .....	5053-019
Replacement Hex Wrench for Micro 100™ Sagittal & Oscillating Saw.....	1365-005
Burguard Sleeve Surgairtome Two.....	1375-112
Smartguard® .....	5020-160
Smartguard Irrigator .....	6020-260



All products may not be available in all markets.

# E9000® System

Indications for Use: ENT, Spine & Neuro

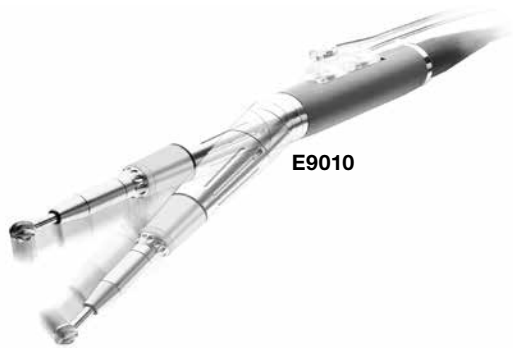

E9010



E9005



E9015

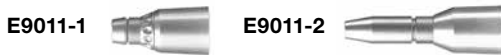

E9011-1

E9011-2



E9011-3



E9011-7



E9011-8



E9011-9



E9012



E9323



E9414



E9415A



E9416



E9315



7020-046

## Handpieces

Cat. No.

CoolFlex® High Speed Drill ..... E9010

High Speed Shaver ..... E9005

Cranial Perforator Drive..... E9015

## Attachments & Accessories

Medium Bur Guard for E9010 Drill ..... E9011-1

Long Bur Guard for E9010 Drill ..... E9011-2

X-Long Bur Guard for E9010 Drill..... E9011-3

Short Neuro Guard for E9010 Drill..... E9011-7

Medium Neuro Guard for E9010 Drill..... E9011-8

Long Neuro Guard for E9010 Drill ..... E9011-9

Locking Collar for E9010 Drill ..... E9012

Bur Rack, Holds up to 20 burs for E9010 Drill ..... E9323

Drill Tubing for E9010 Drill without irrigation tip ..... E9414

Drill Tubing for E9010 Drill with irrigation tip..... E9415A

4.2mm FESS Irrigation Tubing Set for E9005 Shaver ..... E9416

3.7mm FESS Irrigation Tubing Set for E9005 Shaver (Not Shown)..... E9417

DeClogger for removing tissue and bone from shaver blades and burs ..... E9315

Bur Cabinet for Neuro Burs ..... 7020-046

**Handpieces**

	Cat. No.
High Speed Drill.....	7020-001
Low Speed Drill.....	7020-002
Perforator Drive.....	7020-003



**7020-001**



**7020-002**



**7020-003**

**Attachments & Accessories**

Ultrapower Footswitch.....	7020-045
Short Bur Guard (like Midas-X) Red.....	7020-010
Medium Bur Guard I(like Midas-O) Copper.....	7020-011
Long Bur Guard (like Midas-M/B) Mustard.....	7020-012
X-Long Bur Guard (ike Midas-AM/A) Lime.....	7020-013
Short Revision Extension (like Midas TU) Teal.....	7020-014
Medium Revision Extension (like Midas-R) Purple.....	7020-015
Long Revision Extension (like Midas RX) Blue.....	7020-016
Short Bur Guard (like Midas B-5) Black.....	7020-017
Medium Bur Guard (like Midas B-1) Green.....	7020-018
Long Bur Guard (like Midas S-1) Brown.....	7020-019
90 degree Angle Attachment (like Midas AF/BF).....	7020-022
Uses the 5089 and 5090 Series Burs Only	
20 degree Long Keyless Attachment.....	7020-023
Uses the 5092 Series Burs Only.	
20 degree Angle X-Long Keyless Attachment.....	7020-024
Uses the 5093 Series Burs Only.	



**7020-045**

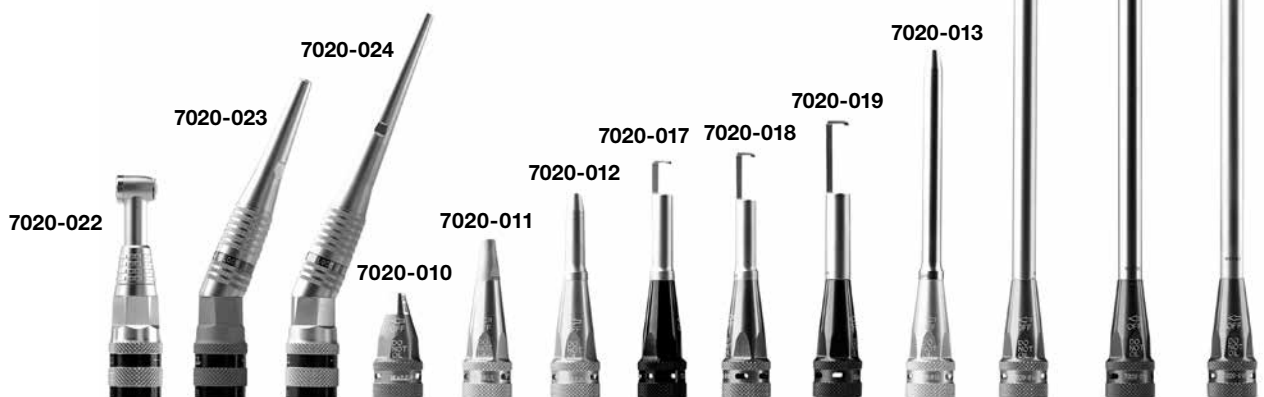

**7020-022**

**7020-023**

**7020-024**

**7020-010**

**7020-011**

**7020-012**

**7020-017**

**7020-018**

**7020-019**

**7020-013**

**7020-014**

**7020-015**

**7020-016**

All products may not be available in all markets.

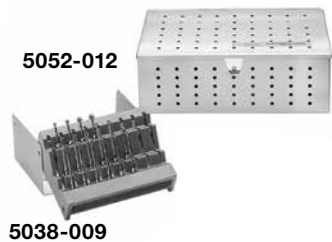

5052-012

5038-009



5038-001



5038-002



5038-004



5038-005



5038-600

## Attachments & Accessories

Cat. No.

Sterilization Case.....	5052-012
Bur Rack, for Osteon™ and Ototom Burs.....	5038-009
Osteon/Ototome Bur Set, includes 16 burs (see System Listings Page 26) .....	5056-109

## Handpieces

Osteon Handpiece, Straight.....	5038-001
Osteon Handpiece, Angled.....	5038-002

## Attachments & Accessories

Osteon Footswitch with Hose .....	5038-004
Osteon Hose .....	5038-005
Osteon Tubing Set with irrigation tip.....	5038-600

MPower® 2 Battery Sternum Saw.....Cat. No. PR06450M  
 See page six (6) for battery accessories.  
 Saw does not include sternum guard or blade.



**PRO6450M**

Pneumatic Sternum Saw.....5059-005



**5059-005**

Sternum Saw Wrench, for PRO6450, PRO6450M & 5059-005 .....5059-007



**5059-007**

Sternum Guard, 2.25" (5.72mm), for PRO6450, PRO6450M & 5059-005.....5059-006



**5059-006**

Sternum Guard, 3.12" (7.92mm), for PRO6450, PRO6450M & 5059-005.....5059-011



**5059-011**

Repeat Sternotomy Saw, Pneumatic.....5057-040



All products may not be available in all markets.



## Handpieces

Cat. No.

Cebotome® Revision Drill Handpiece ..... 5052-041

## Attachments & Accessories

Cebotome Bur Wrench.....5052-046

Cebotome Metal Cutting Bur Wrench ..... 5052-143

Standard Bur Extension, Short, use with standard Cebotome Burs .....5052-042

Standard Bur Extension, Medium, use with standard Cebotome Burs .....5052-048

Standard Bur Extension, Long, use with standard Cebotome Burs.....5052-049

Metal Cutting Bur Extension, use with metal cutting wheels and diamond metal cutting burs..... 5052-142

Universal Hose, 10' (3.05m)..... 5052-010

**Handpiece**

StapLizer® Handpiece.....T100

Cat. No.

**Attachments & Accessories**

StapLizer Carrier, 7mm .....T107

StapLizer Carrier, 10mm .....T110

StapLizer Carrier, 13mm .....T113

StapLizer Carrier, 16mm .....T116

Drill Guide, 7mm .....T307

Drill Guide, 10mm .....T310

Drill Guide, 13mm.....T313

Drill Guide, 16mm .....T316

Staple Pry .....T121

Staple Seater .....T122

Width Gauge .....T123

Punch Disassembly Tool .....T301

Hose, 10' (3.05m) .....A201



**T100**



**T107**



**T110**



**T113**



**T116**



**T307**

**T310**

**T313**

**T316**



**T121**



**T122**



**T123**



**T301**



**A201**

All products may not be available in all markets.





1375-015



5052-012



PRO6001

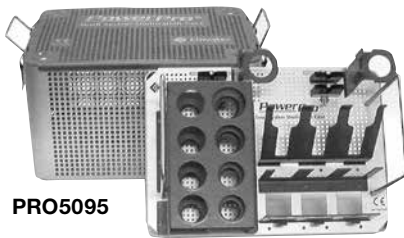

PRO5095

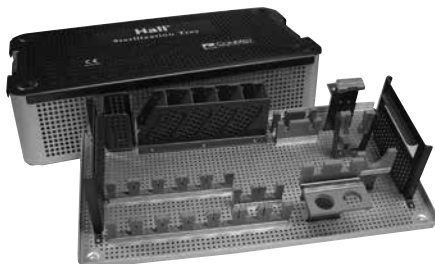

PRO6000



5030-029

5030-028

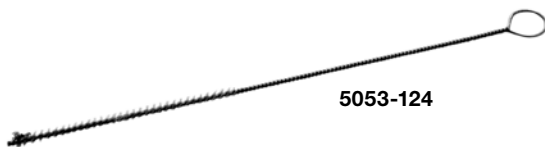

5053-124

Bur Brush..... Cat. No. 1375-015

Standard Case ..... 5052-012

Large Bone Tray with Battery Holders.....PRO6001

Large Bone Tray .....PRO5095

Small Bone Tray .....PRO6000

**Holding Clamps for use with 5030-010 & 5030-020**

Small .....5030-028

Medium.....5030-029

Cleaning Brush for Cannulated Handpieces .....5053-124

## Surgairtome Two® System

*Components Ordered Separately*

	Cat. No.
Surgairtome Two Handpiece .....	5058-001
Medium Bur Guard .....	1375-012
Standard Case .....	5052-012
Universal Hose, 10' (3.05m).....	5052-010
Bur Cleaning Brush.....	1375-015

## Ultrapower® Complete Drill System Product Listing

High Speed Drill.....	7020-001
Low Speed Drill .....	7020-002
Perforator Drive .....	7020-003
Universal Hose, 10' (3.05m).....	5052-010
Short Bur Guard like Midas-X, Red.....	7020-010
Medium Bur Guard like Midas-O, Copper .....	7020-011
Long Bur Guard like Midas-M/B, Mustard .....	7020-012
X-Long Bur Guard like Midas-AM/A, Lime .....	7020-013
Short Revision Extension like Midas TU, Teal .....	7020-014
Medium Revision Extension like Midas-R, Purple .....	7020-015
Long Revision Extension like Midas RX, Blue .....	7020-016
Short Bur Guard like Midas B-5, Black.....	7020-017
Medium Bur Guard like Midas B-1, Green.....	7020-018
Long Bur Guard like Midas S-1, Brown .....	7020-019
90 degree Angle Attachment like Midas AF/BF.....	7020-022
20 degree Long Keyless Attachment .....	7020-023
20 degree Angle X-Long Keyless Attachment .....	7020-024
Key Wrench, 2 per box .....	7020-040
Footswitch.....	7020-045
Storage Cabinet for Neuro Burs.....	7020-046
Attachment Spray.....	7020-041



All products may not be available in all markets.



## Ultrapower® Neuro/Spine Drill System Product Listing

*Components Ordered Separately*

	Cat. No.
High Speed Drill.....	7020-001
Low Speed Drill .....	7020-002
Perforator Drive .....	7020-003
Universal Hose, 10' (3.05m).....	5052-010
Short Bur Guard like Midas-X, Red.....	7020-010
Medium Bur Guard like Midas-O, Copper .....	7020-011
Long Bur Guard like Midas-M/B, Mustard .....	7020-012
X-Long Bur Guard like Midas-AM/A, Lime .....	7020-013
Short Bur Guard like Midas B-5, Black.....	7020-017
Medium Bur Guard like Midas B-1, Green.....	7020-018
Long Bur Guard like Midas S-1, Brown .....	7020-019
90 degree Angle Attachment like Midas AF/BF.....	7020-022
20 degree Long Keyless Attachment .....	7020-023
20 degree Angle X-Long Keyless Attachment .....	7020-024
Key Wrench, 2 per box .....	7020-040
Footswitch.....	7020-045
Storage Cabinet for Neuro Burs.....	7020-046
Attachment Spray .....	7020-041

## Ultrapower Basic Drill System Product Listing

*Components Ordered Separately*

High Speed Drill.....	7020-001
Universal Hose, 10' (3.05m).....	5052-010
Short Bur Guard like Midas-X, Red.....	7020-010
Medium Bur Guard like Midas-O, Copper .....	7020-011
Long Bur Guard like Midas-M/B, Mustard .....	7020-012
X-Long Bur Guard like Midas-AM/A, Lime .....	7020-013
Short Revision Extension like Midas TU, Teal.....	7020-014
Medium Revision Extension like Midas-R, Purple .....	7020-015
Long Revision Extension like Midas RX, Blue.....	7020-016
Short Bur Guard like Midas B-5, Black.....	7020-017
Medium Bur Guard like Midas B-1, Green.....	7020-018
Long Bur Guard like Midas S-1, Brown .....	7020-019
90 degree Angle Attachment like Midas AF/BF.....	7020-022
20 degree Long Keyless Attachment .....	7020-023
20 degree Angle X-Long Keyless Attachment .....	7020-024
Key Wrench, 2 per box .....	7020-040
Footswitch.....	7020-045
Storage Cabinet for Neuro Burs.....	7020-046
Attachment Spray .....	7020-041



## Osteon™/Ototome Burs

*Components Ordered Separately*

	Cat. No.
Round Carbide Bur, 6.5 x 30 mm, 2 each .....	5056-117
Round Carbide Bur, 5.0 x 30mm.....	5056-118
Round Carbide Bur, 4.0 x 30mm.....	5056-119
Round Carbide Bur, 5.0 x 38mm.....	5056-126
Round Steel Bur, 1.5 x 48mm.....	5056-140
Round Steel Bur, 2.0 x 48mm.....	5056-142
Round Carbide Bur, 4.0 x 48mm.....	5056-145
Round Carbide Bur, 3.0 x 48mm.....	5056-146
Round Diamond Bur, 4.0 x 48mm.....	5056-152
Round Diamond Bur, 1.0 x 48mm .....	5056-158
Round Diamond Bur, 3.0 x 48mm.....	5056-159
Round Diamond Bur, 0.5 x 48mm.....	5056-161
Round Diamond Bur, 2.0 x 48mm.....	5056-162
Round Steel Bur, 1.0 x 48mm.....	5056-164
Round Steel Bur, 0.5 x 48mm.....	5056-166

## Osteon Drill System with Burs

*Components Ordered Separately*

Bur Brush Accessory .....	1375-015
Osteon Footswitch with Universal Hose 5052-010.....	5038-004
Osteon Hose .....	5038-005
Osteon/Ototome Bur Rack .....	5038-009
Osteon Handpiece, Straight.....	5038-001
Osteon Handpiece, Angled.....	5038-002



All products may not be available in all markets.



## Osteon™ Drill System without Bur System

*Components Ordered Separately*

	Cat. No.
Bur Brush Accessory .....	1375-015
Osteon Footswitch with Universal Hose 5052-010 .....	5038-004
Osteon Hose .....	5038-005
Osteon/Ototome Bur Rack .....	5038-009
Osteon Handpiece, Straight.....	5038-001
Osteon Handpiece, Angled.....	5038-002



## Revision Drill System

*Components Ordered Separately*

Universal Hose, 10' (3.05m).....	5052-010
Cebotome Revision Drill Handpiece .....	5052-041
Cebotome Bur Extension, Short.....	5052-042
Cebotome Wrench.....	5052-046
Cebotome Bur Extension, Medium.....	5052-048



## Cebotome Metal Cutting Wheel System

*Components Ordered Separately*

Cebotome Metal Cutting Wheel.....	5052-125
Cebotome Metal Trimming Wheel.....	5052-126
Cebotome Metal Cutting Wheel Wrench .....	5052-129

## Cebotome Metal Cutting Bur System

*Components Ordered Separately*

Cebotome Metal Cutting Bur Extension .....	5052-142
Cebotome Metal Cutting Bur Wrench .....	5052-143
ST Cebotome Metal Cutting Bur, Side, Flat.....	5052-144
ST Cebotome Metal Cutting Bur, Side, Round.....	5052-145

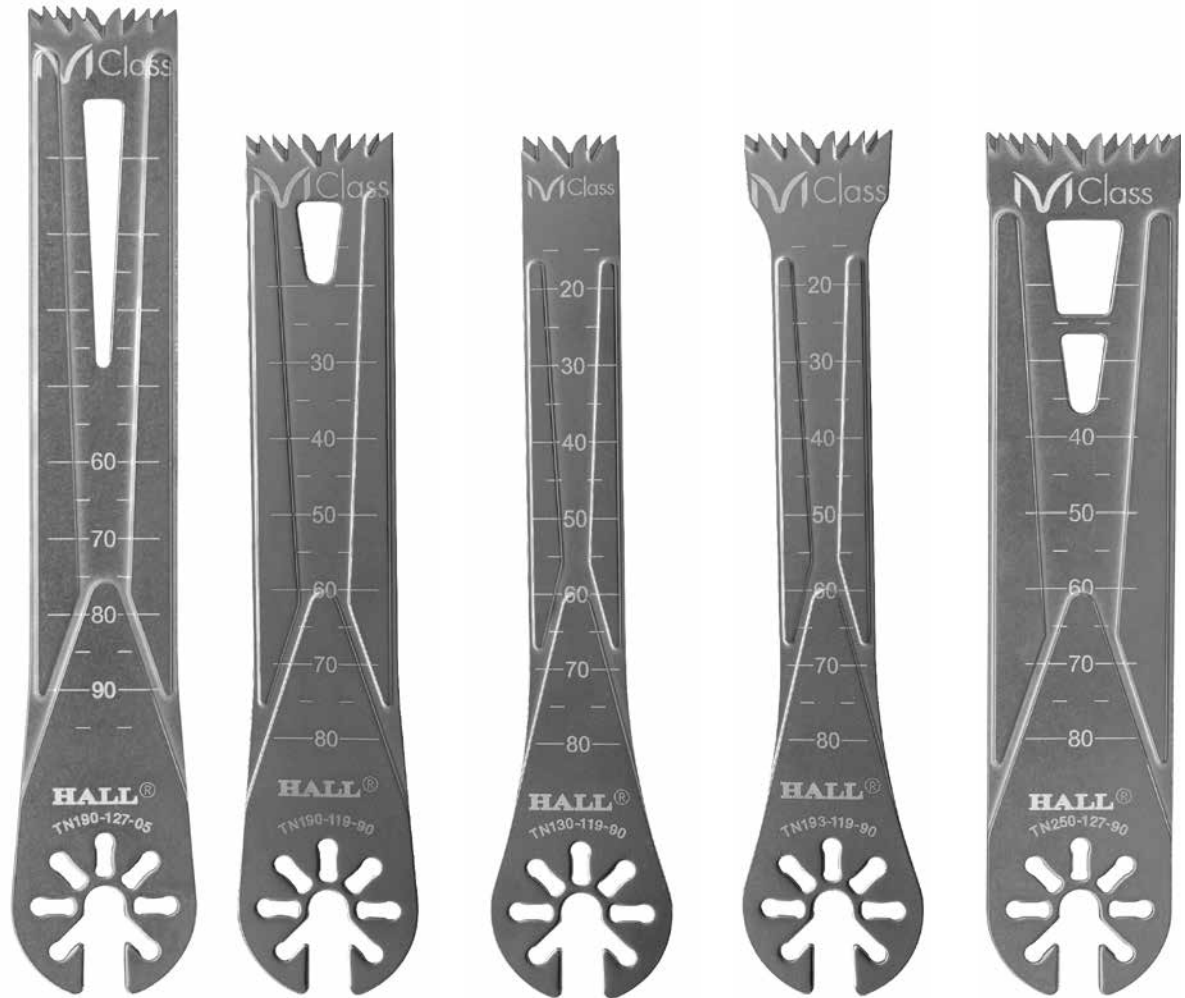

Blades images are 1:1 in length and width.

Body Width	19.0mm	19.0mm	13.0mm	19.0/13.0mm	25.0mm
Length	105.0mm	90.0mm	90.0mm	90.0mm	90.0mm
<b>Thickness</b>	<b>Blade Catalog #</b>				
0.89mm		TN190-089-90	TN130-089-90		TN250-089-90
1.00mm		TN190-100-90	TN130-100-90		TN250-100-90
1.07mm		TN190-107-90	TN130-107-90		TN250-107-90
1.19mm	TN190-119-05	TN190-119-90	TN130-119-90	TN193-119-90	TN250-119-90
1.27mm	TN190-127-05	TN190-127-90	TN130-127-90	TN193-127-90	TN250-127-90
1.37mm	TN190-137-05	TN190-137-90	TN130-137-90	TN193-137-90	TN250-137-90
1.47mm		TN190-147-90	TN130-147-90		TN250-147-90

All products may not be available in all markets.

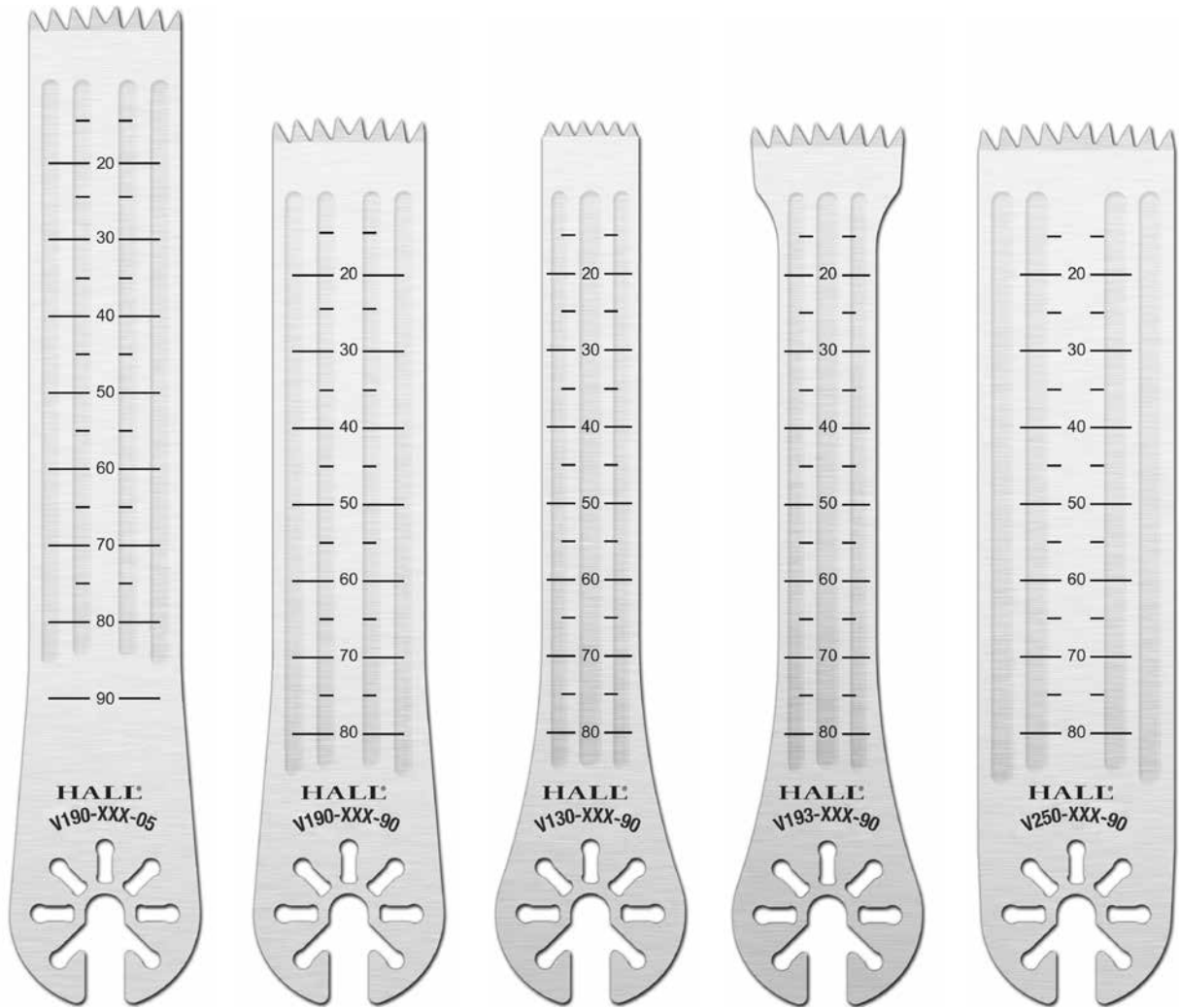

Blades images are 1:1 in length and width.

Body Width	19.0mm	19.0mm	13.0mm	19.0/13.0mm	25.0mm
Length	105.0mm	90.0mm	90.0mm	90.0mm	90.0mm
Thickness	Blade Catalog #				
0.89mm	V190-089-05	V190-089-90	V130-089-90		V250-089-90
1.00mm	V190-100-05	V190-100-90	V130-100-90		V250-100-90
1.07mm	V190-107-05	V190-107-90	V130-107-90		V250-107-90
1.19mm	V190-119-05	V190-119-90	V130-119-90	V193-119-90	V250-119-90
1.27mm	V190-127-05	V190-127-90	V130-127-90	V193-127-90	V250-127-90
1.37mm	V190-137-05	V190-137-90	V130-137-90	V193-137-90	V250-137-90
1.47mm	V190-147-05	V190-147-90	V130-147-90		V250-147-90

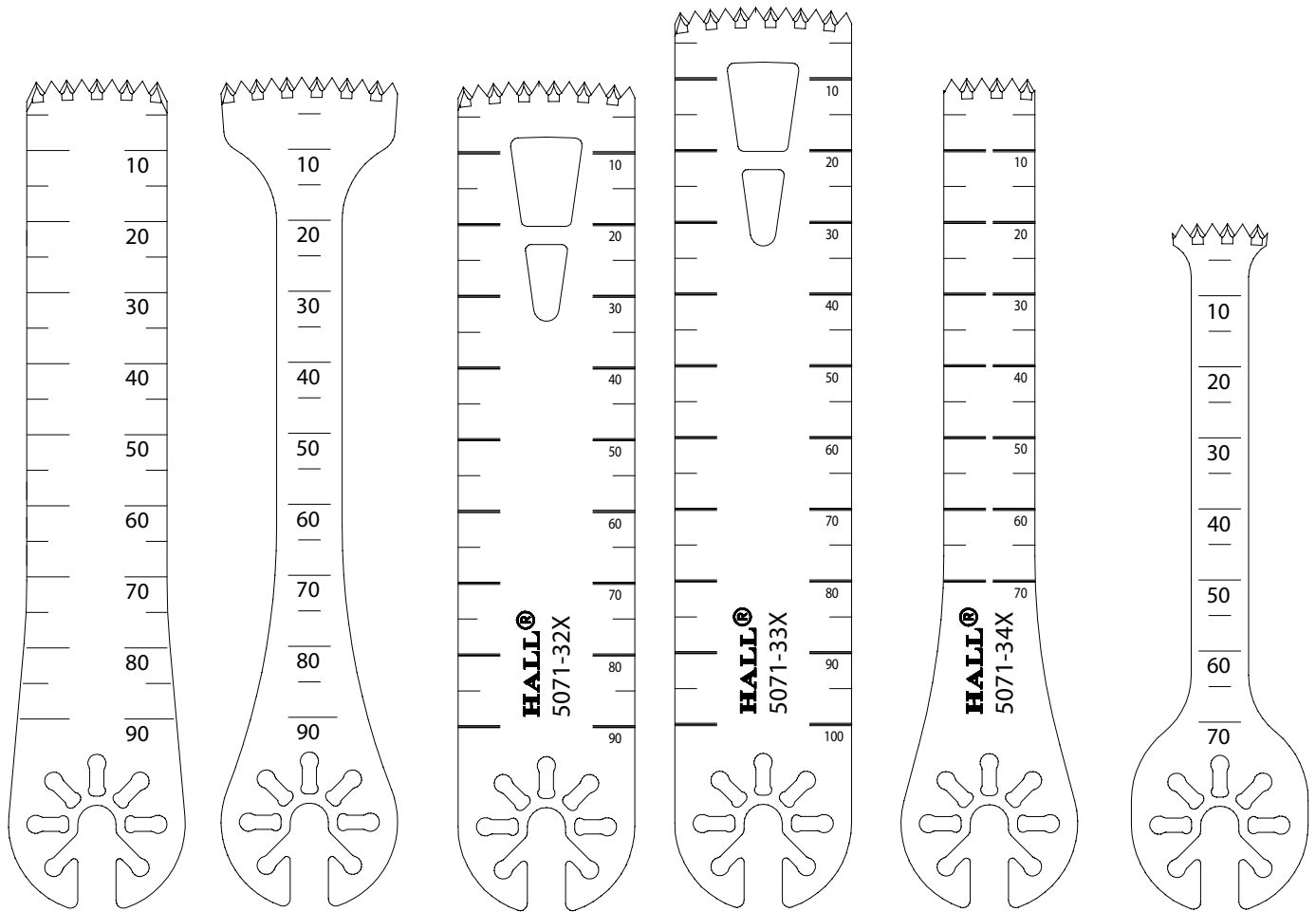

5071-30X

5071-31X

5071-32X

5071-33X

5071-34X

5071-35X

Blades images are 1:1 in length and width.

	Standard	MIS	Standard/ Wide	Standard/Long	Standard/ Narrow	Unicondylar
Head Width	19.5mm	25.0mm	25.0mm	25.0mm	12.5mm	13.0mm
Body Width	19.5mm	9.0mm	25.0mm	25.0mm	12.5mm	8.0mm
Length	90.0mm	90.0mm	90.0mm	100.0mm	90.0mm	70.0mm
<b>Thickness</b>	<b>Blade Catalog #</b>					
0.89mm	5071-300	5071-310	5071-320	5071-330	5071-340	5071-350
1.00mm	5071-301	5071-311	5071-321	5071-331	5071-341	5071-351
1.07mm	5071-302	5071-312	5071-322	5071-332	5071-342	5071-352
1.19mm	5071-303	5071-313	5071-323	5071-333	5071-343	5071-353
1.27mm	5071-304	5071-314	5071-324	5071-334	5071-344	5071-354
1.37mm	5071-305	5071-315	5071-325	5071-335	5071-345	5071-355
1.47mm	5071-306	5071-316	5071-326	5071-336	5071-346	5071-356

All products may not be available in all markets.



# Large Bone Knee Blades

Indication for Use: Total Knee Arthroplasty



## Hall® Blades

Cat. No.	Width (mm)	Length (mm)	Material Thickness (mm)	Cut Thickness (mm)	View Illustration
5071-594	29.46	58.70	0.64	0.64	Page 33
5271-502	29.00	74.00	0.64	0.64	Page 33
5071-528	25.00	73.00	0.89	0.89	Page 33
5071-533	21.00	84.50	0.89	0.89	Page 33
5071-583	12.70	90.00	0.89	0.89	Page 33
5071-589	13.00	90.00	0.89	0.89	Page 33
5071-532	12.00	80.00	0.90	0.90	Page 33
5071-185	19.50	80.00	0.90	0.90	Page 33
5071-195	19.50	80.00	0.90	0.90	Page 34
5071-146	25.40	90.00	0.90	0.90	Page 34
5071-196	25.40	90.00	0.90	0.90	Page 34
5071-120	19.50	95.00	0.90	0.90	Page 34
5071-121	25.40	95.00	0.90	0.90	Page 34
5071-562	25.40	90.00	1.00	1.00	Page 34
5071-538	25.40	95.00	1.00	1.00	Page 34
5071-548	12.70	86.00	1.19	1.19	Page 34
5071-547	25.40	86.00	1.19	1.19	Page 35
5071-167	19.50	90.00	1.20	1.20	Page 35
5071-184	19.50	90.00	1.20	1.20	Page 35
5071-558	18.50	73.00	1.24	1.24	Page 35
5071-534	25.40	79.50	1.24	1.24	Page 35
5071-570-50	25.00	95.00	1.24	1.24	Page 35
5071-526	18.50	107.00	1.24	1.24	Page 35
5071-573	18.50	90.00	1.26	1.26	Page 35
5071-527	19.00	80.00	1.27	1.27	Page 36
5071-180	10.00	85.00	1.27	1.27	Page 36
5271-580	10.00	85.00	1.27	1.27	Page 36
5071-531	25.40	85.00	1.27	1.27	Page 36
5071-181	19.50	86.00	1.27	1.27	Page 36
5071-201	19.50	86.00	1.27	1.27	Page 36
5071-582	13.00	90.00	1.27	1.27	Page 36
5071-161	25.40	90.00	1.27	1.27	Page 37
5071-564	25.40	90.00	1.27	1.27	Page 37
5271-561	25.40	90.00	1.27	1.27	Page 37
5071-590	13.00	95.00	1.27	1.27	Page 37
5071-568	16.50	95.00	1.27	1.27	Page 37
5071-576	16.50	95.00	1.27	1.27	Page 37
5071-123	19.50	95.00	1.27	1.27	Page 37
5071-519	21.00	95.00	1.27	1.27	Page 37
5071-124	25.40	95.00	1.27	1.27	Page 38
5071-129	19.50	105.00	1.27	1.27	Page 38
5071-529	19.50	105.00	1.27	1.27	Page 38
5071-163	25.40	90.00	1.37	1.37	Page 38
5071-525	19.00	95.00	1.37	1.37	Page 38
5071-530	19.00	95.00	1.37	1.37	Page 38
5071-539	25.40	95.00	1.37	1.37	Page 38
5071-565	25.40	90.00	1.47	1.47	Page 38
5071-144	25.40	90.00	1.50	1.50	Page 38

All products may not be available in all markets.

# Large Bone Knee Blades

Indication for Use: Total Knee Arthroplasty

5071-594

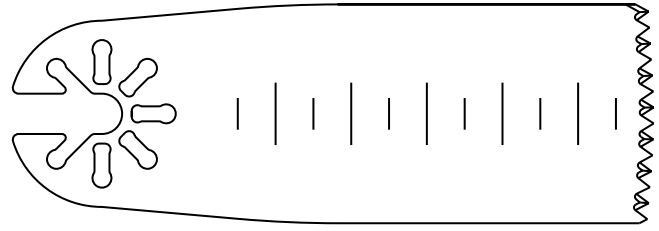

5271-502

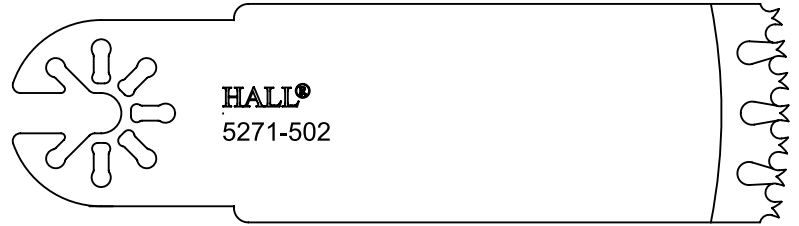

5071-528

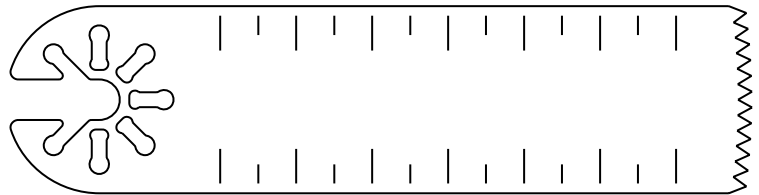

5071-533

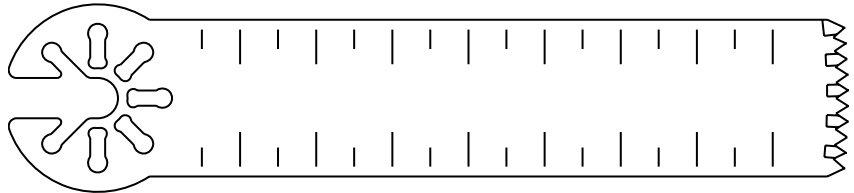

5071-583

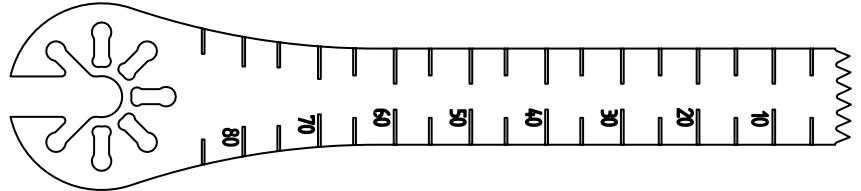

5071-589

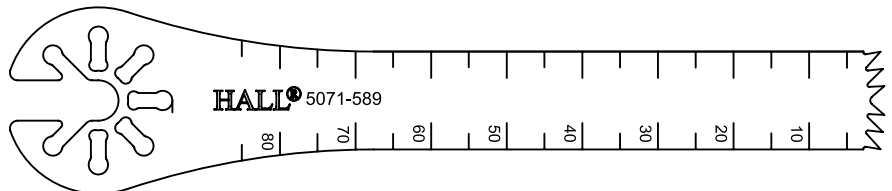

5071-532

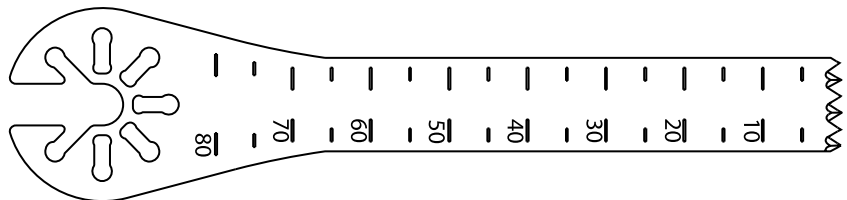

5071-185

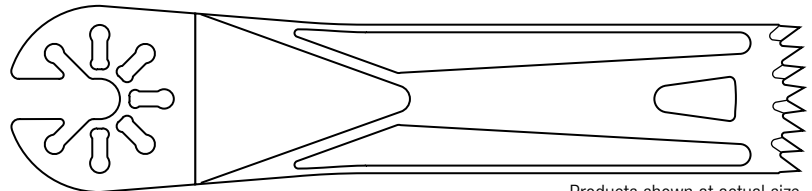

Products shown at actual size.  
All products may not be available in all markets.

# Large Bone Knee Blades

Indication for Use: Total Knee Arthroplasty

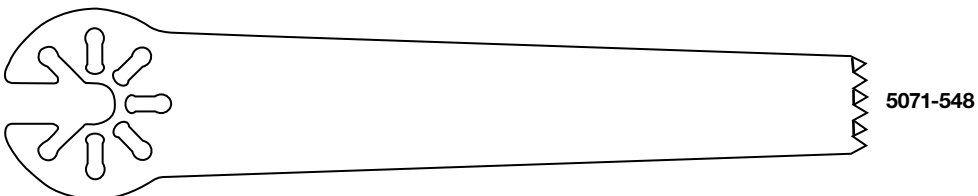
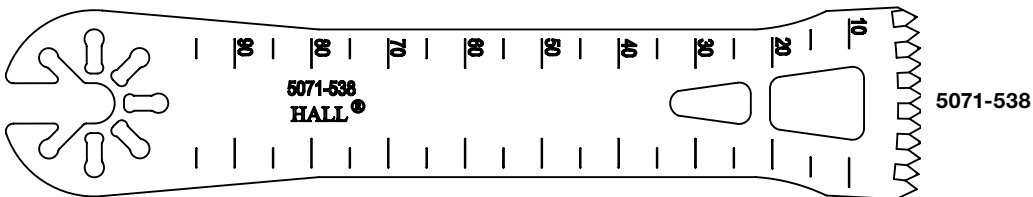
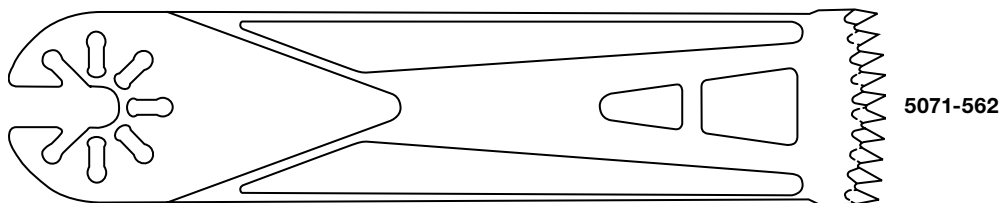
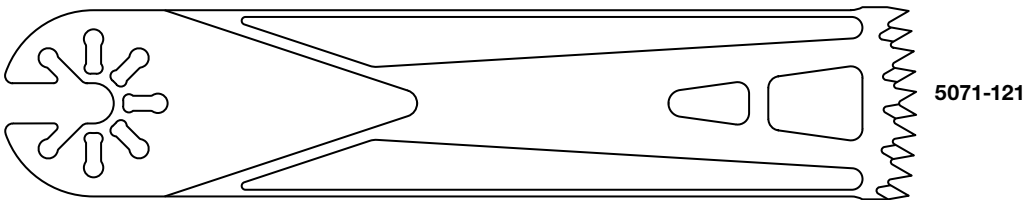
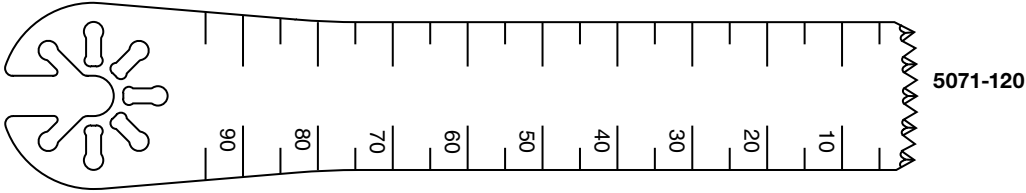
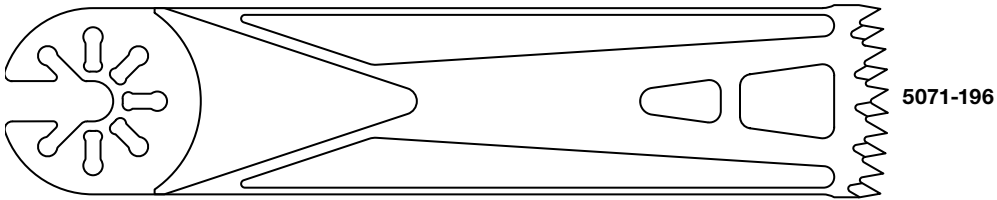
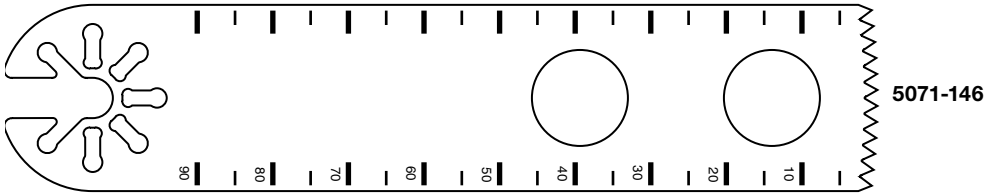
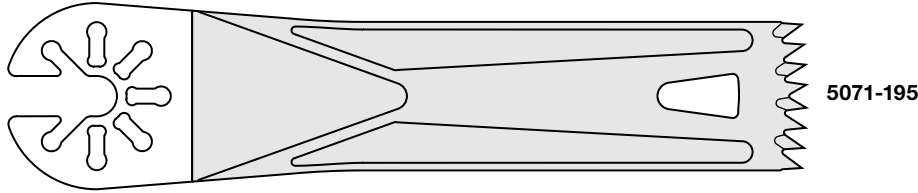

Shaded blades indicate coating.  
Products shown at actual size.  
All products may not be available in all markets.

# Large Bone Knee Blades

Indication for Use: Total Knee Arthroplasty

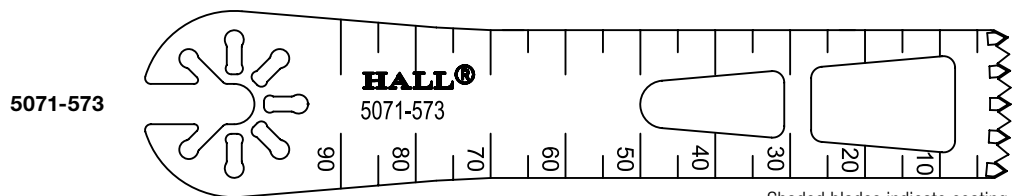
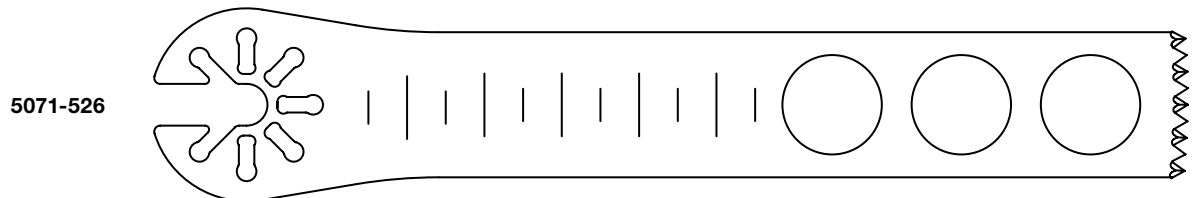
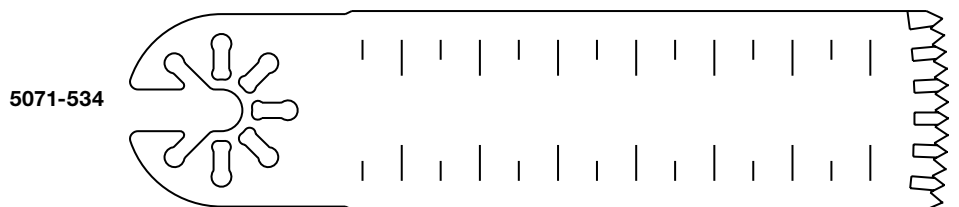
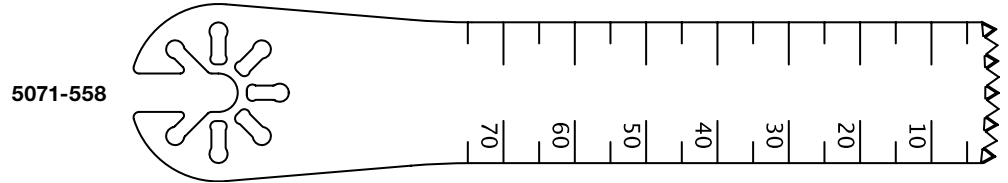
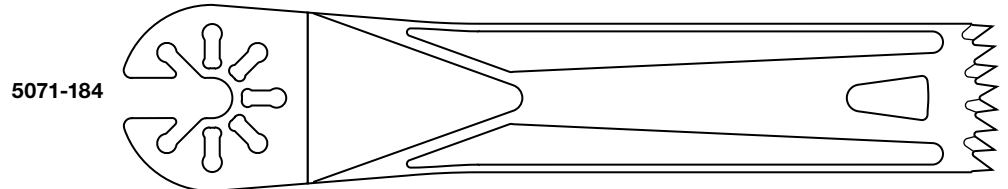
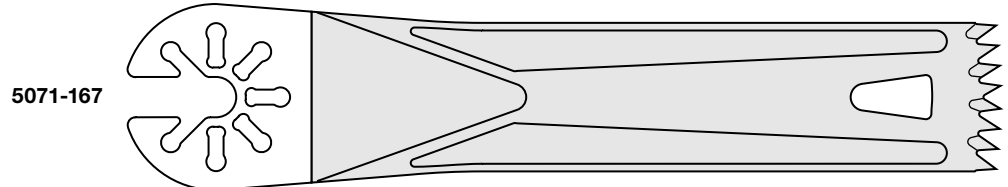
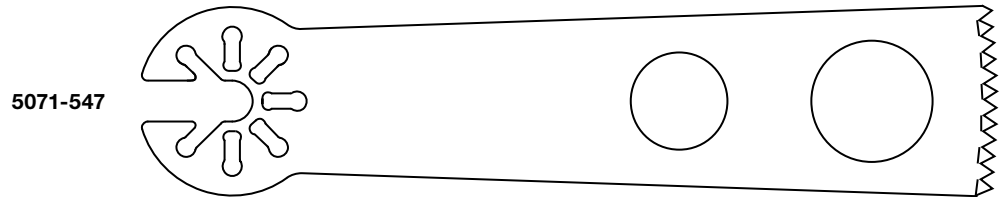

Shaded blades indicate coating.  
Products shown at actual size.  
All products may not be available in all markets.

# Large Bone Knee Blades

Indication for Use: Total Knee Arthroplasty

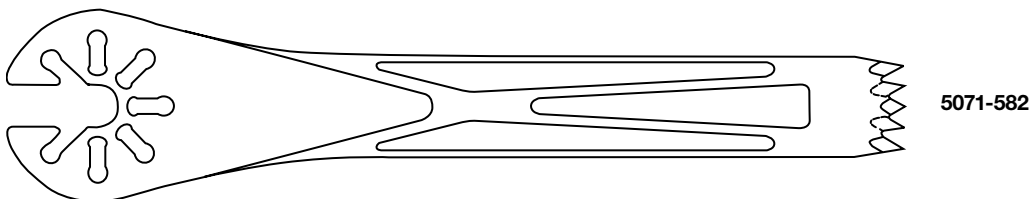
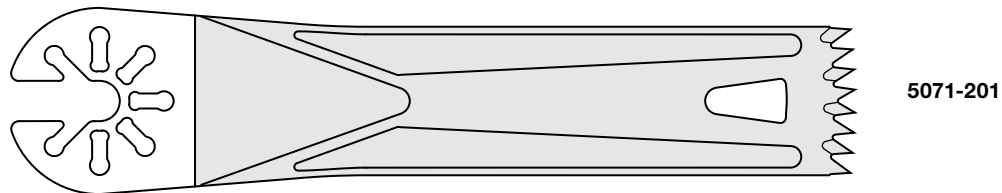
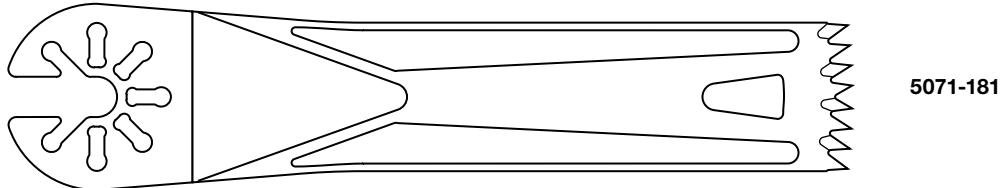
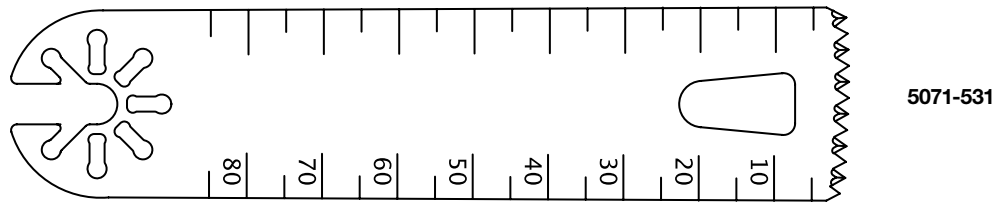
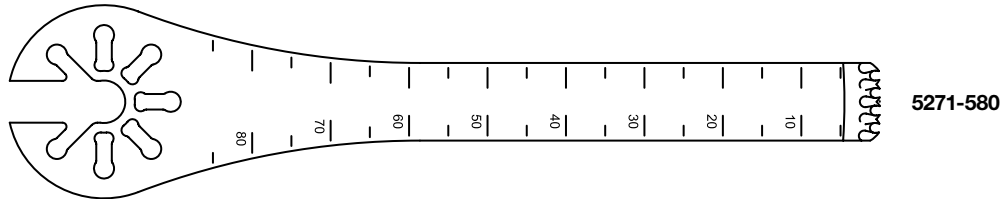
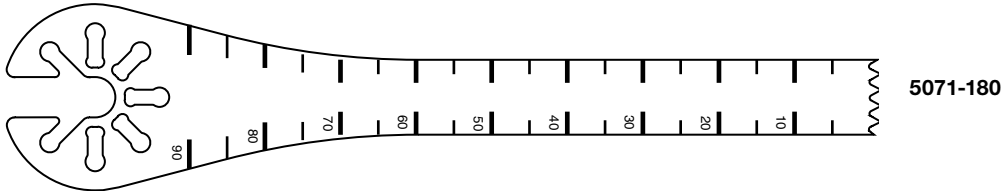
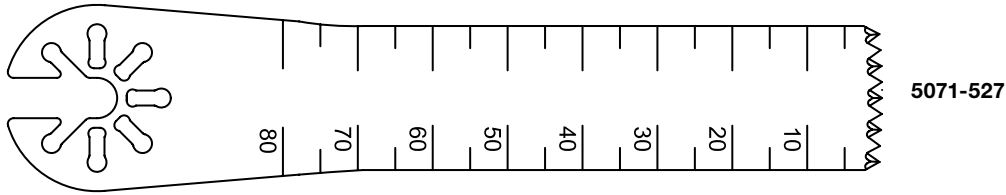

Shaded blades indicate coating  
Products shown at actual size.  
All products may not be available in all markets.

# Large Bone Knee Blades

Indication for Use: Total Knee Arthroplasty

5071-161

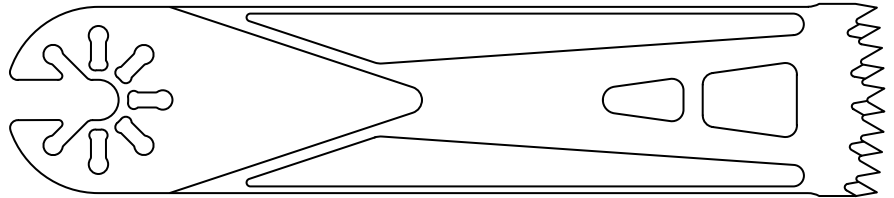

5071-564

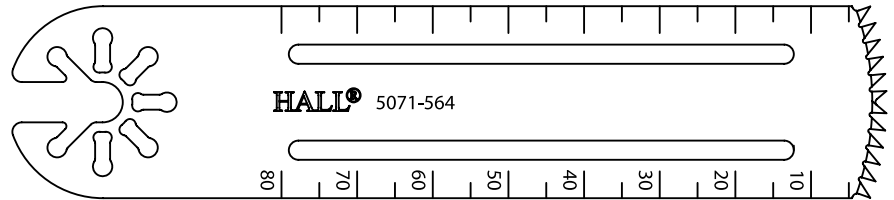

5271-561

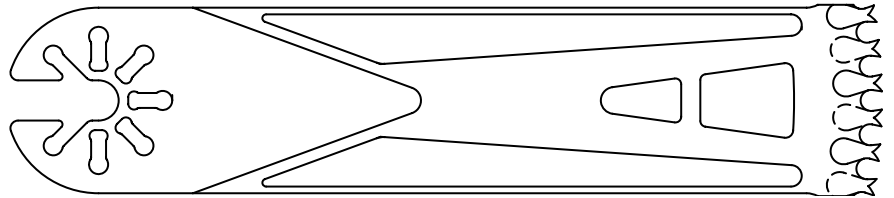

5071-590

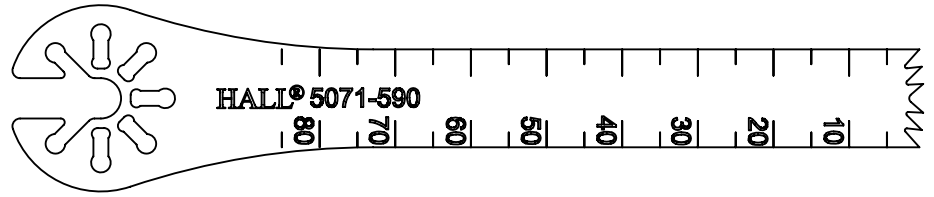

5071-568



5071-576

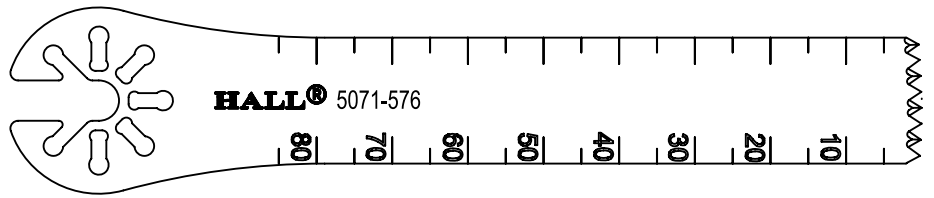

5071-123

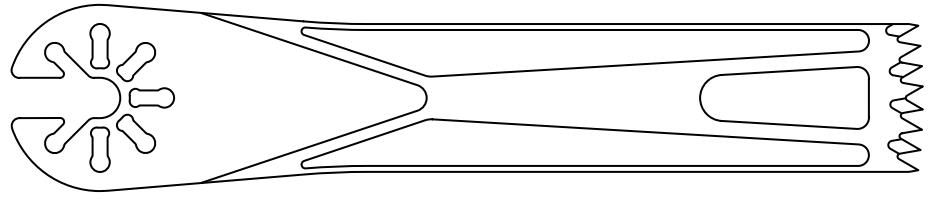

5071-519



Products shown at actual size.  
All products may not be available in all markets.

# Large Bone Knee Blades

Indication for Use: Total Knee Arthroplasty

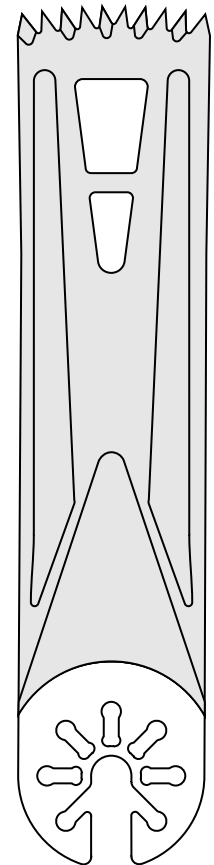
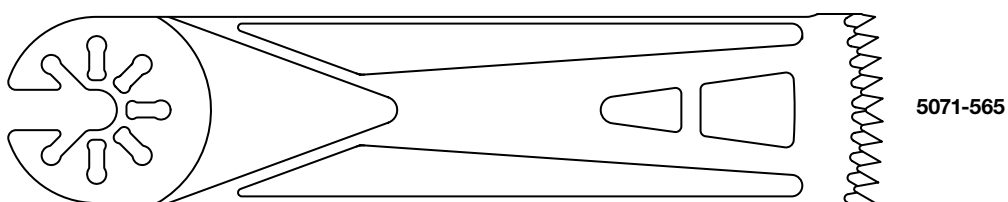
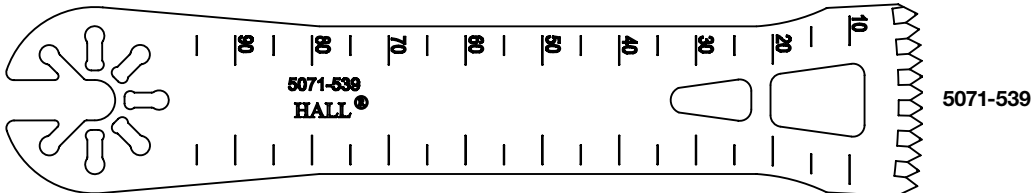
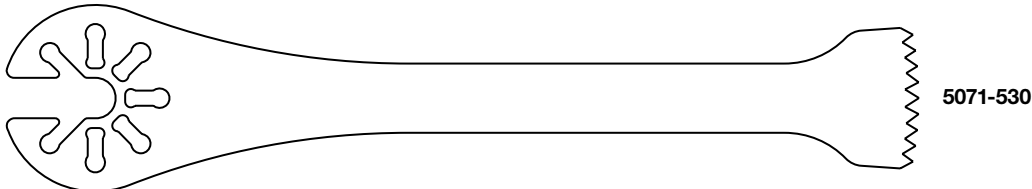
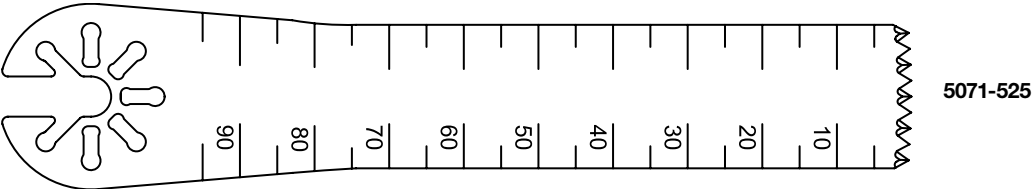
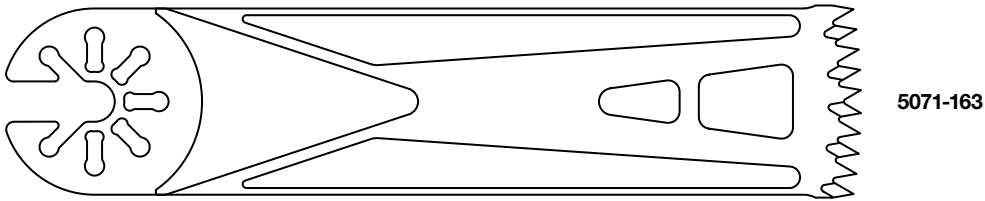
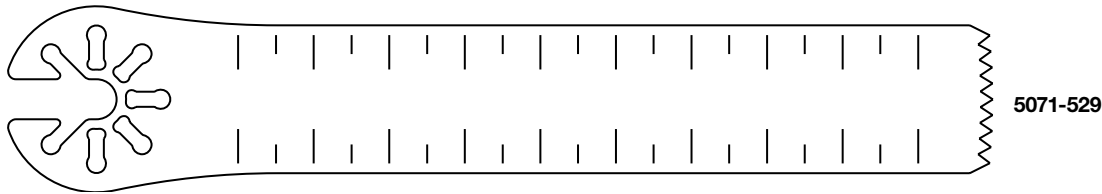
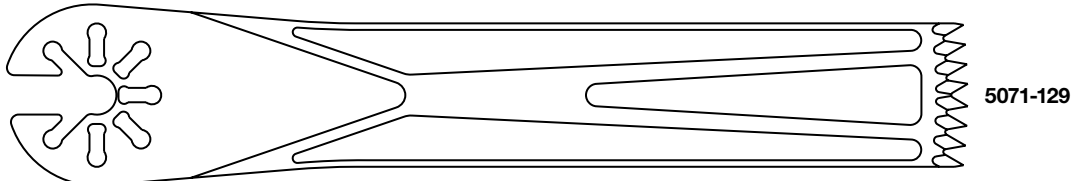
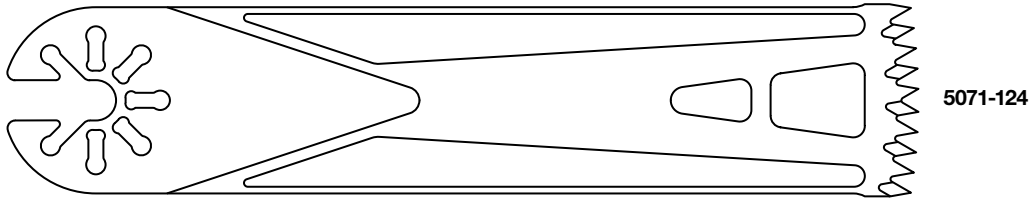

Shaded blades indicate coating.  
Products shown at actual size.

All products may not be available in all markets.

## Stryker Blades

For use with: System 2000, System 4 & 5

Cat. No.	Width (mm)	Length (mm)	Material Thickness (mm)	Cut Thickness (mm)	View Illustration
5072-145	9.12	25.22	0.64	0.64	Page 39
5072-140	29.46	58.70	0.64	0.64	Page 39
5072-100	25.00	73.79	0.64	0.64	Page 39
5072-150	12.50	73.80	0.64	0.64	Page 39
5072-143	25.40	90.00	0.80	0.80	Page 39
5072-105	24.82	73.79	0.89	0.89	Page 40
5072-109	20.70	85.04	0.89	0.89	Page 40
5072-102	24.82	90.47	0.89	0.89	Page 40
5072-195	19.50	80.00	0.90	0.90	Page 40
5072-152	12.50	82.18	1.20	1.20	Page 40
5072-151	25.00	85.67	1.20	1.20	Page 40
5072-142	25.40	90.00	1.20	1.20	Page 40
5072-218	25.00	98.50	1.24	1.24	Page 40
5072-185	18.50	104.00	1.24	1.24	Page 41
5072-110	24.82	73.79	1.27	1.27	Page 41
5072-111	24.82	80.14	1.27	1.27	Page 41
5072-158	12.50	82.20	1.27	1.27	Page 41
5072-183	29.00	84.47	1.27	1.27	Page 41
5072-101	19.50	86.00	1.27	1.27	Page 41
5072-181	19.50	86.00	1.27	1.27	Page 41
5072-177	25.00	82.42	1.37	1.37	Page 41
5072-176	25.00	80.14	1.50	1.50	Page 41

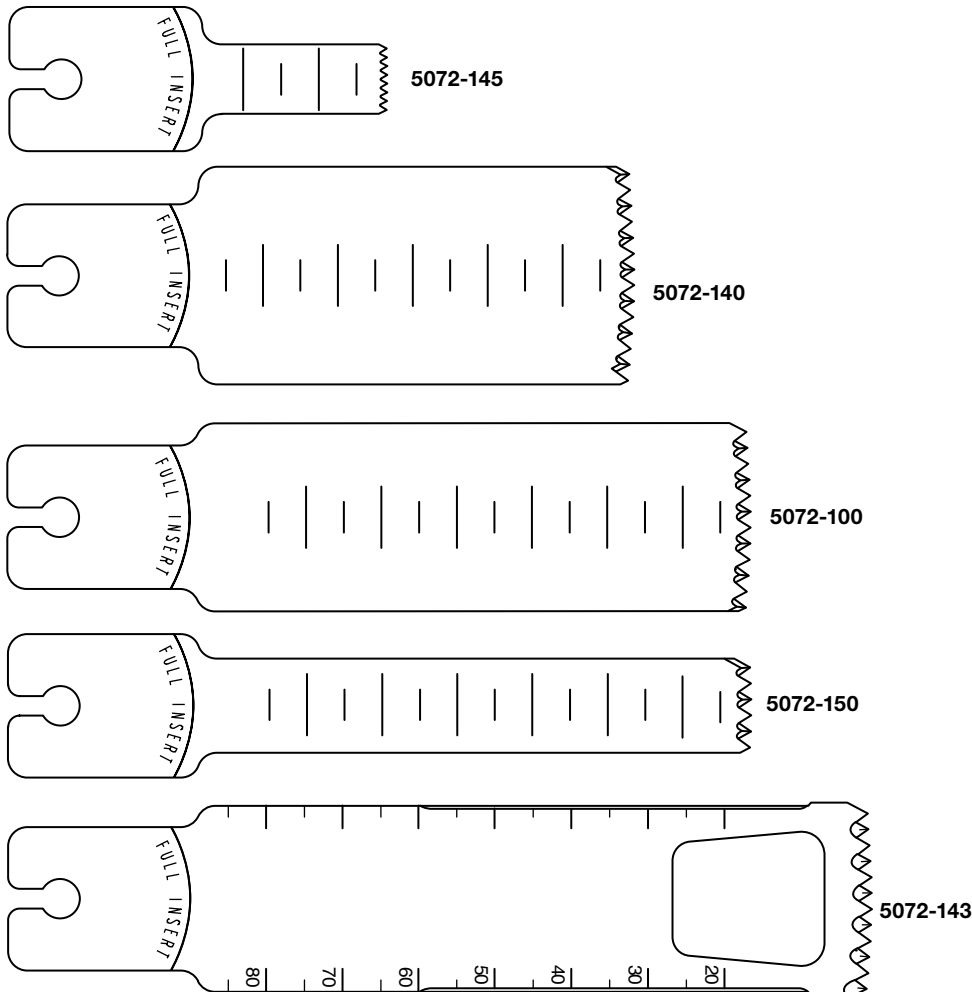

Products shown at actual size.  
All products may not be available in all markets.



# Large Bone Knee Blades

Indication for Use: Total Knee Arthroplasty

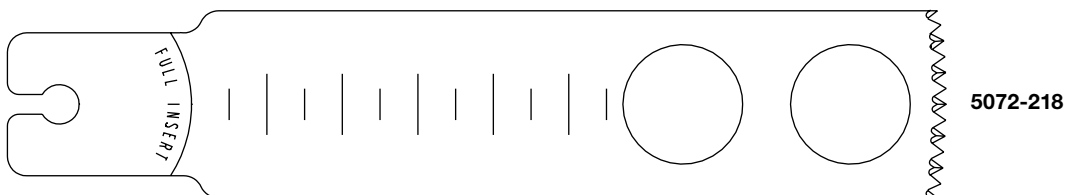
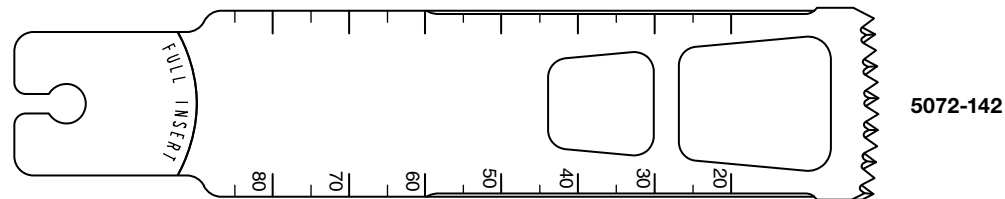
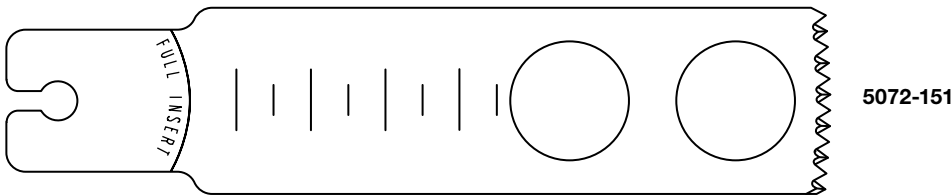
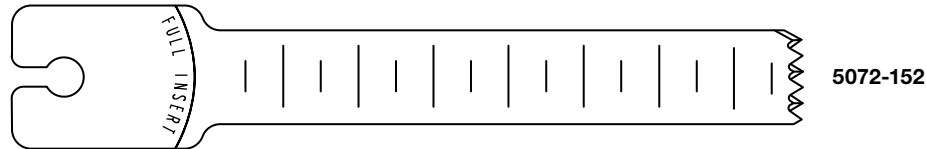
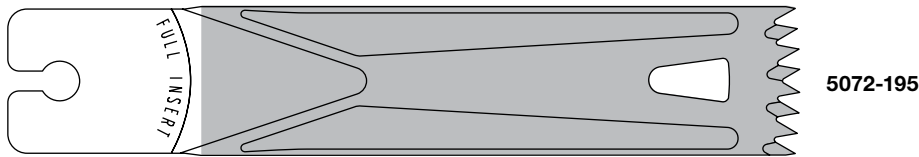
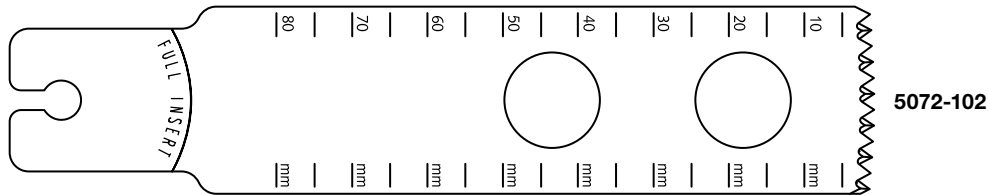
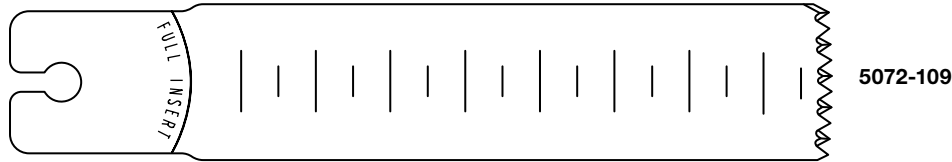
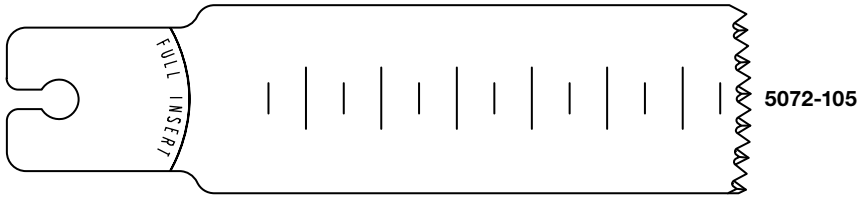

Shaded blades indicate coating.

Products shown at actual size.

All products may not be available in all markets.

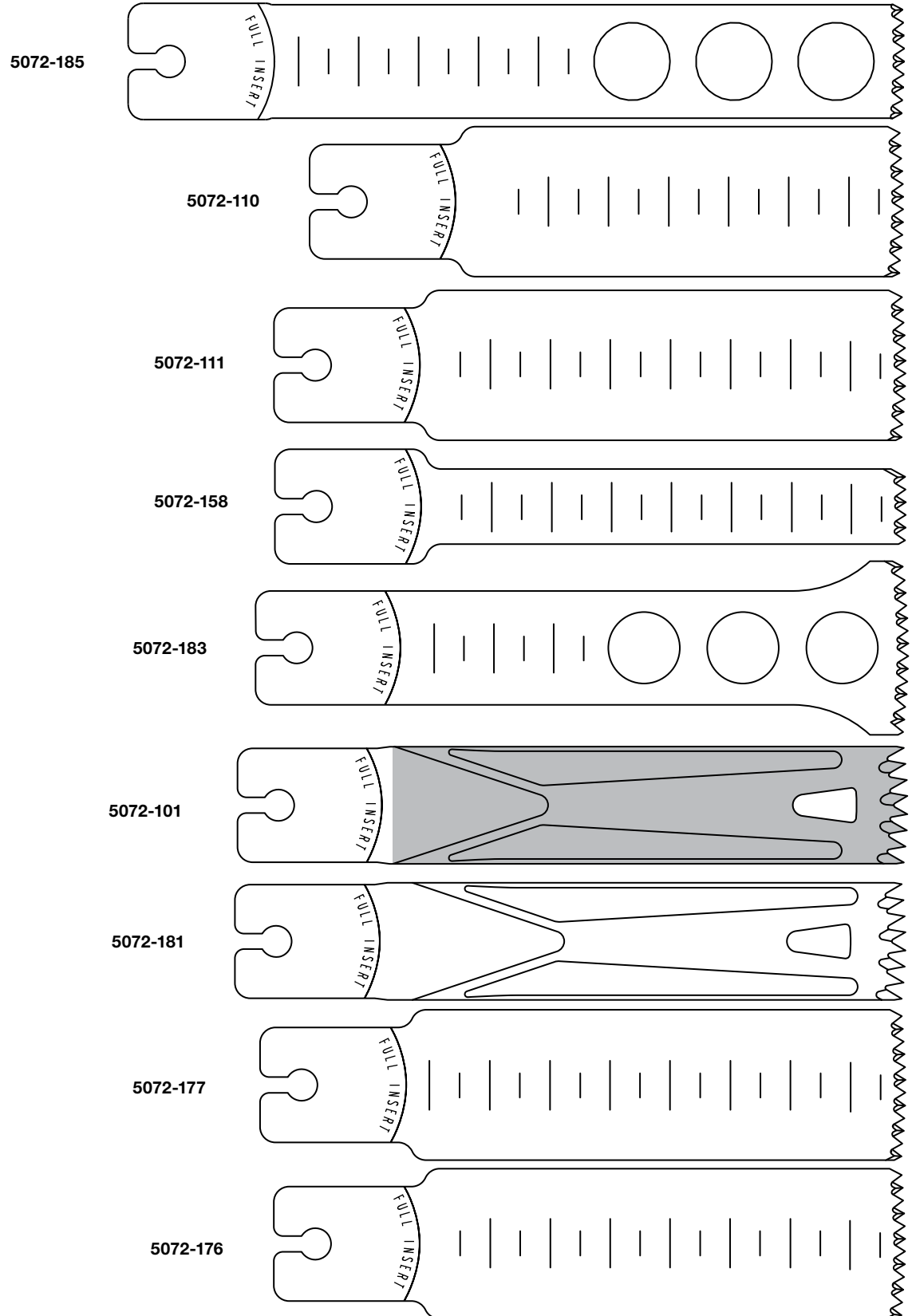

Shaded blades indicate coating.  
 Products shown at actual size.  
 All products may not be available in all markets.

# Large Bone Oscillating Blades

ACL Blades



## Graft Harvesting Blades

Cat. No.	Depth Stop (mm)	Width (mm)	Material Thickness (mm)	Cut Thickness (mm)
5071-105	20.00	16.50	0.40	5.00
5071-106	20.00	16.50	0.40	6.00
5071-107	20.00	16.50	0.40	7.00
5071-108	20.00	16.50	0.40	8.00
5071-109	20.00	16.50	0.40	9.00
5071-110	20.00	16.50	0.40	10.00
5071-111	20.00	16.50	0.40	11.00
5071-112	20.00	16.50	0.40	12.00
5071-113	20.00	16.50	0.40	13.00

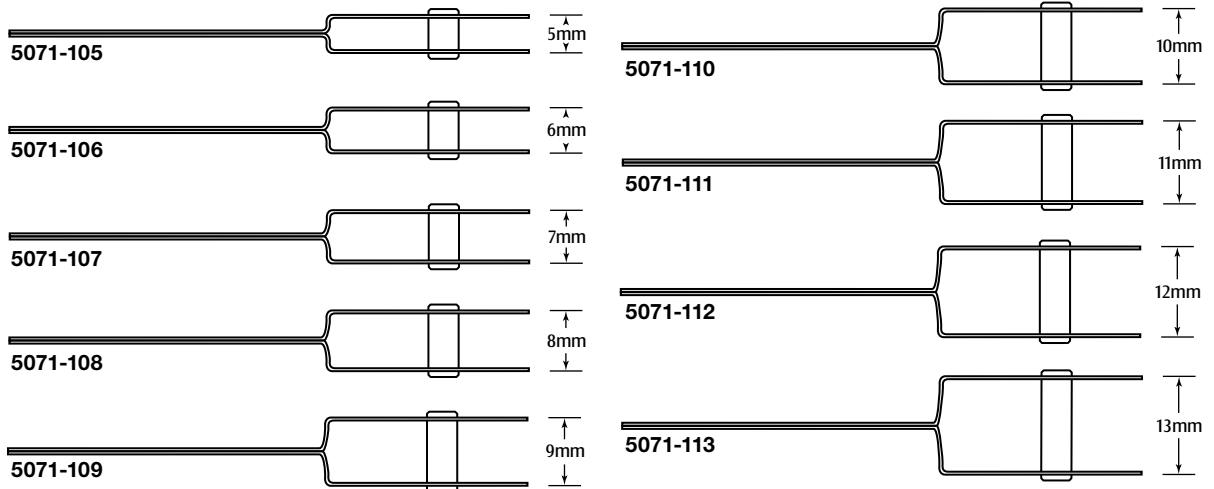

## ACL Blades

Cat. No.	Width (mm)	Length (mm)	Material Thickness (mm)	Cut Thickness (mm)
5071-127	8.50	38.00	0.40	0.80
5071-135	5.00	30.00	0.60	1.10
5071-246	5.50	25.50	0.60	0.80
5071-236	9.12	25.22	0.64	0.64
5071-571	9.50	30.00	0.64	0.84
5071-133	9.50	25.50	0.40	0.60
5071-134	9.00	41.00	0.40	0.60

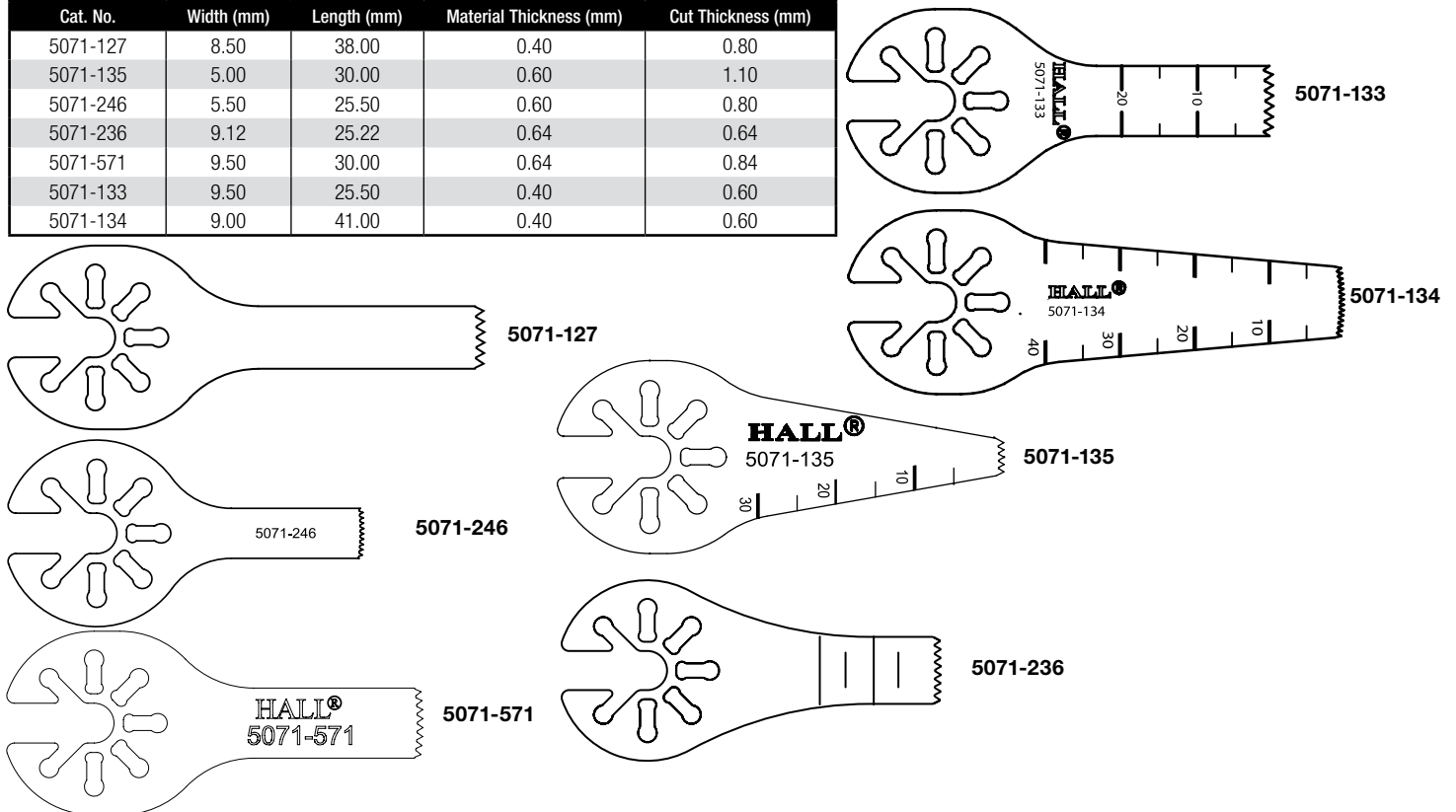

Products shown at actual size.

All products may not be available in all markets.

## Oscillating Blades

Cat. No.	Width (mm)	Length (mm)	Material Thickness (mm)	Cut Thickness (mm)	View Illustration
5071-132	19.50	41.00	0.40	0.80	Page 43
5071-553	19.50	63.00	0.60	0.90	Page 43
5071-551	32.50	63.00	0.60	0.90	Page 43
5071-550	49.00	63.00	0.60	0.90	Page 44
5071-552	13.50	64.00	0.60	0.90	Page 44
5071-166	32.00	64.00	0.80	0.90	Page 44
5071-186	32.00	64.00	0.80	0.90	Page 44
5071-556	33.50	64.00	0.80	0.90	Page 44
5071-177	19.50	71.00	0.80	0.90	Page 44
5071-187	19.50	71.00	0.80	0.90	Page 45
5071-572	19.50	71.00	0.80	0.90	Page 45
5071-178	19.50	80.00	0.80	0.90	Page 45
5071-188	19.50	80.00	0.80	0.90	Page 45
5071-174	19.50	86.00	0.80	0.90	Page 45
5071-143	25.40	90.00	0.80	0.90	Page 45
5071-560	25.40	95.00	0.86	1.00	Page 45
5071-557	12.50	73.80	0.63	1.06	Page 45
5071-554	19.50	71.00	1.20	1.40	Page 46
5071-141	19.50	80.00	1.20	1.40	Page 46
5071-140	25.40	80.00	1.20	1.40	Page 46
5071-142	25.40	90.00	1.20	1.40	Page 46
5071-555	33.00	71.00	1.20	1.50	Page 46
5071-145	13.00	72.00	1.20	1.50	Page 46

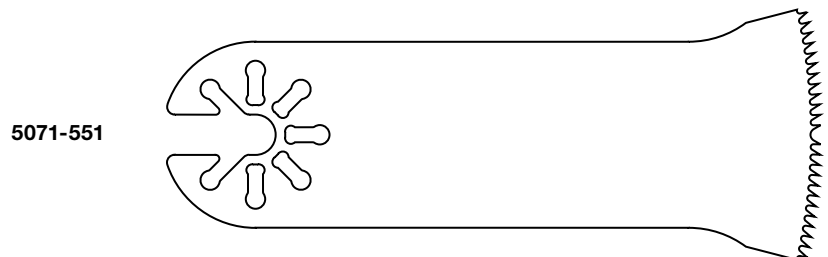
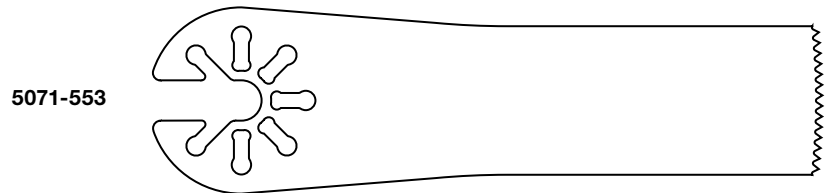
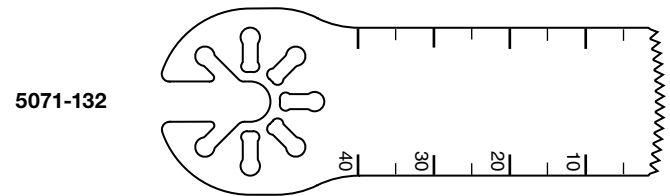

Products shown at actual size.  
All products may not be available in all markets.

# Large Bone Oscillating Blades

Indications for Use: Total Hip Arthroplasty  
& Large Bone Trauma

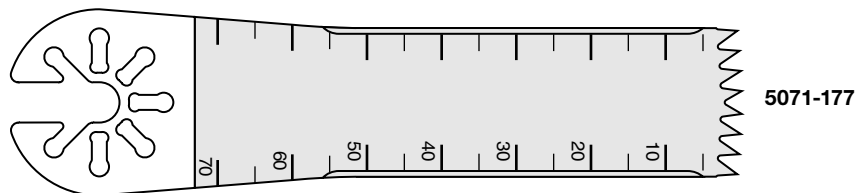
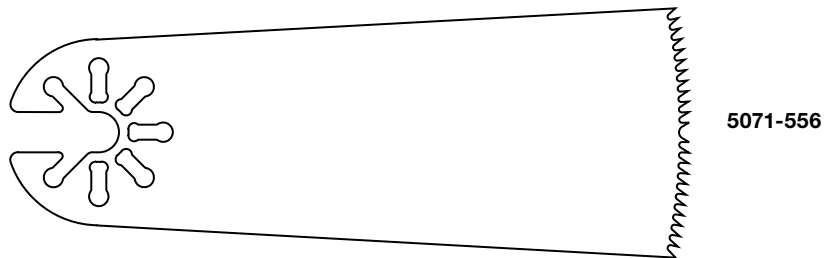
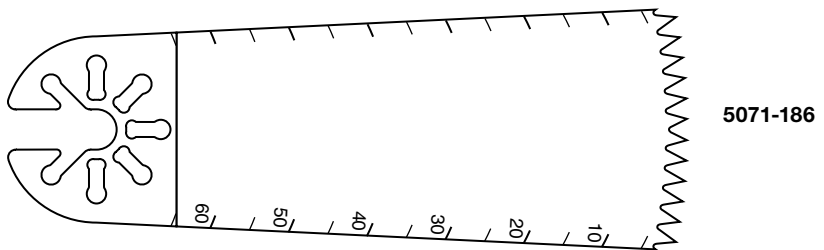
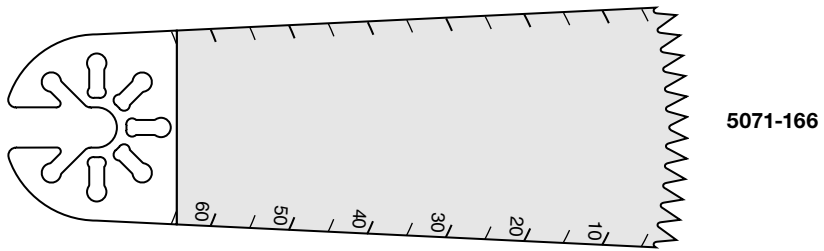
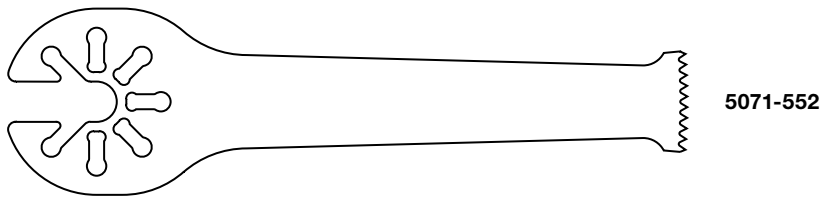
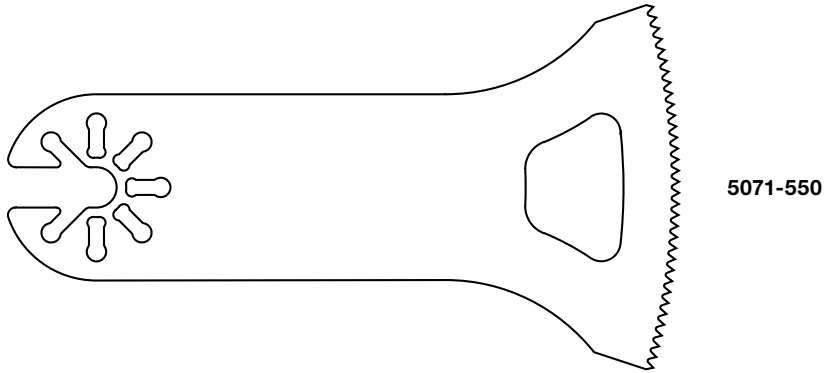

Shaded blades indicate coating  
Products shown at actual size.

All products may not be available in all markets.

# Large Bone Oscillating Blades

Indications for Use: Total Hip Arthroplasty & Large Bone Trauma

5071-187

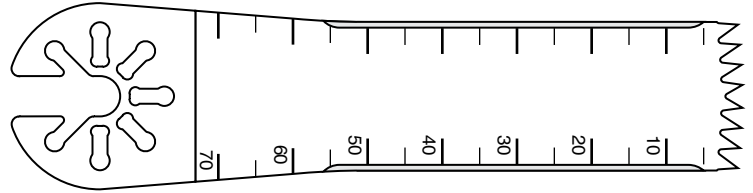

5071-572

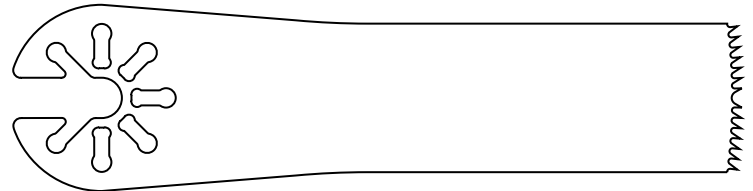

5071-178

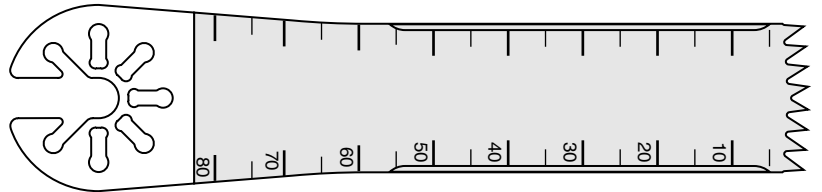

5071-188

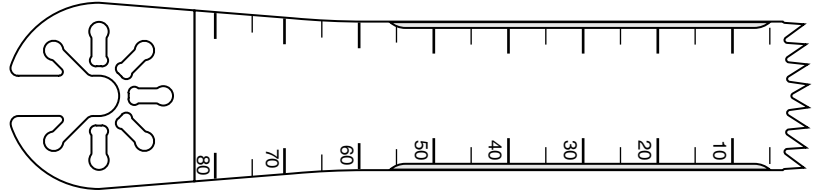

5071-174

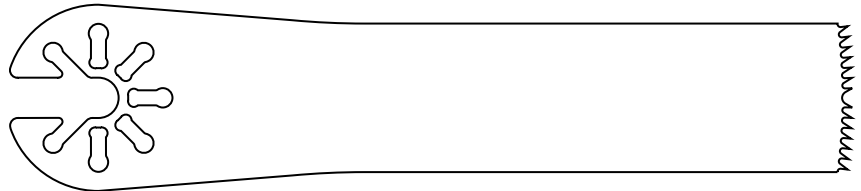

5071-143

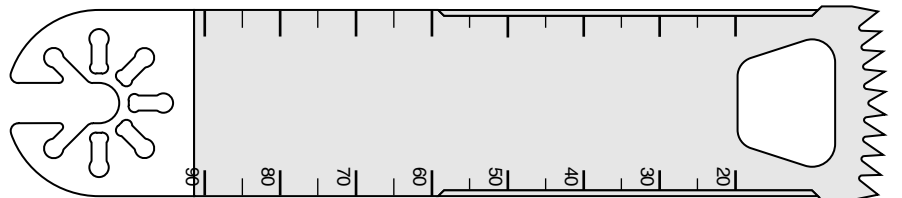

5071-560

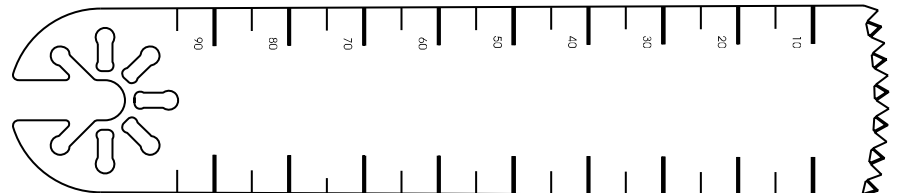

5071-557

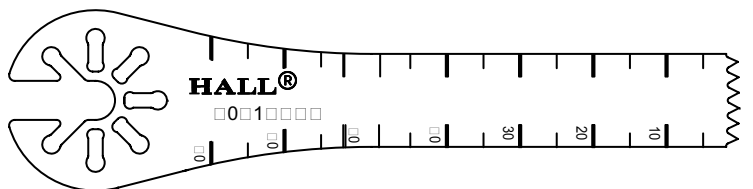

Shaded blades indicate coating  
Products shown at actual size.

All products may not be available in all markets.

# Large Bone Oscillating Blades

Indications for Use: Total Hip Arthroplasty  
& Large Bone Trauma

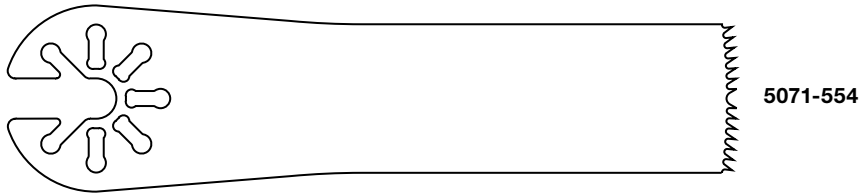

5071-554

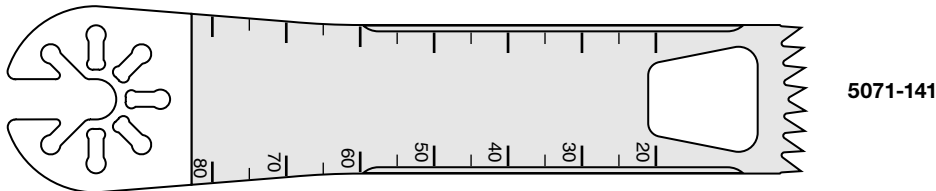

5071-141

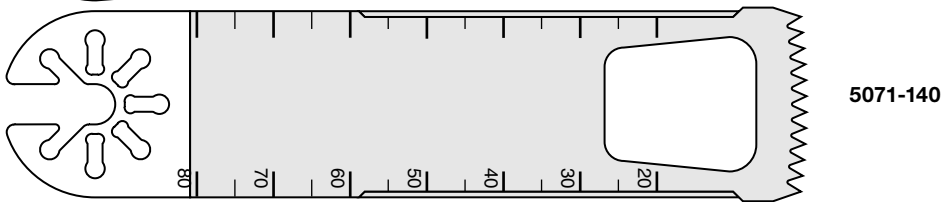

5071-140

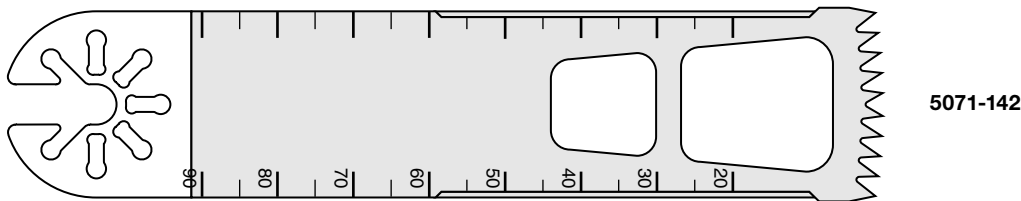

5071-142

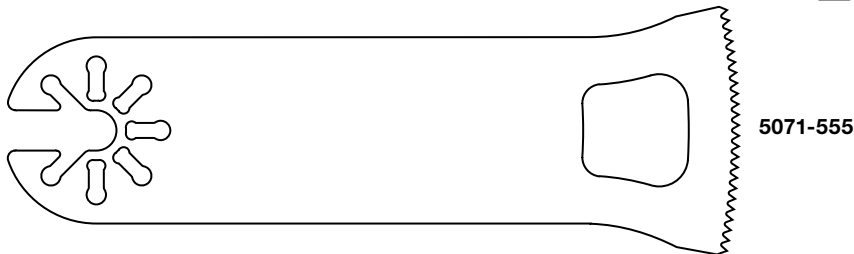

5071-555

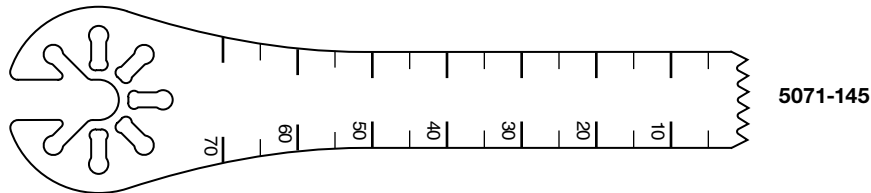

5071-145

## Oscillating Abrader

Cat. No.	Width (mm)	Length (mm)
5071-175	20.00	45.70

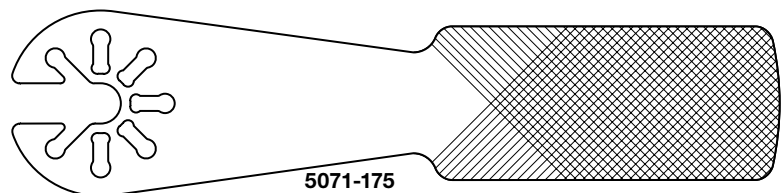

5071-175

Shaded blades indicate coating.  
Products shown at actual size.

All products may not be available in all markets.

## Hall® Reciprocating Blades

Cat. No.	Width (mm)	Length (mm)	Material Thickness (mm)	Cut Thickness (mm)
5052-260	12.50	38.00	0.40	0.60
5052-179	12.50	76.00	0.90	0.90
5052-259	9.40	54.50	0.60	1.00
5052-173	12.50	73.50	0.80	1.00
5052-258	12.50	89.00	0.60	1.00
5052-291	12.50	76.00	1.27	1.27
5052-276	13.00	48.00	1.50	1.50
5052-281	9.40	54.50	1.50	1.50
5052-261	12.50	89.00	1.50	1.60

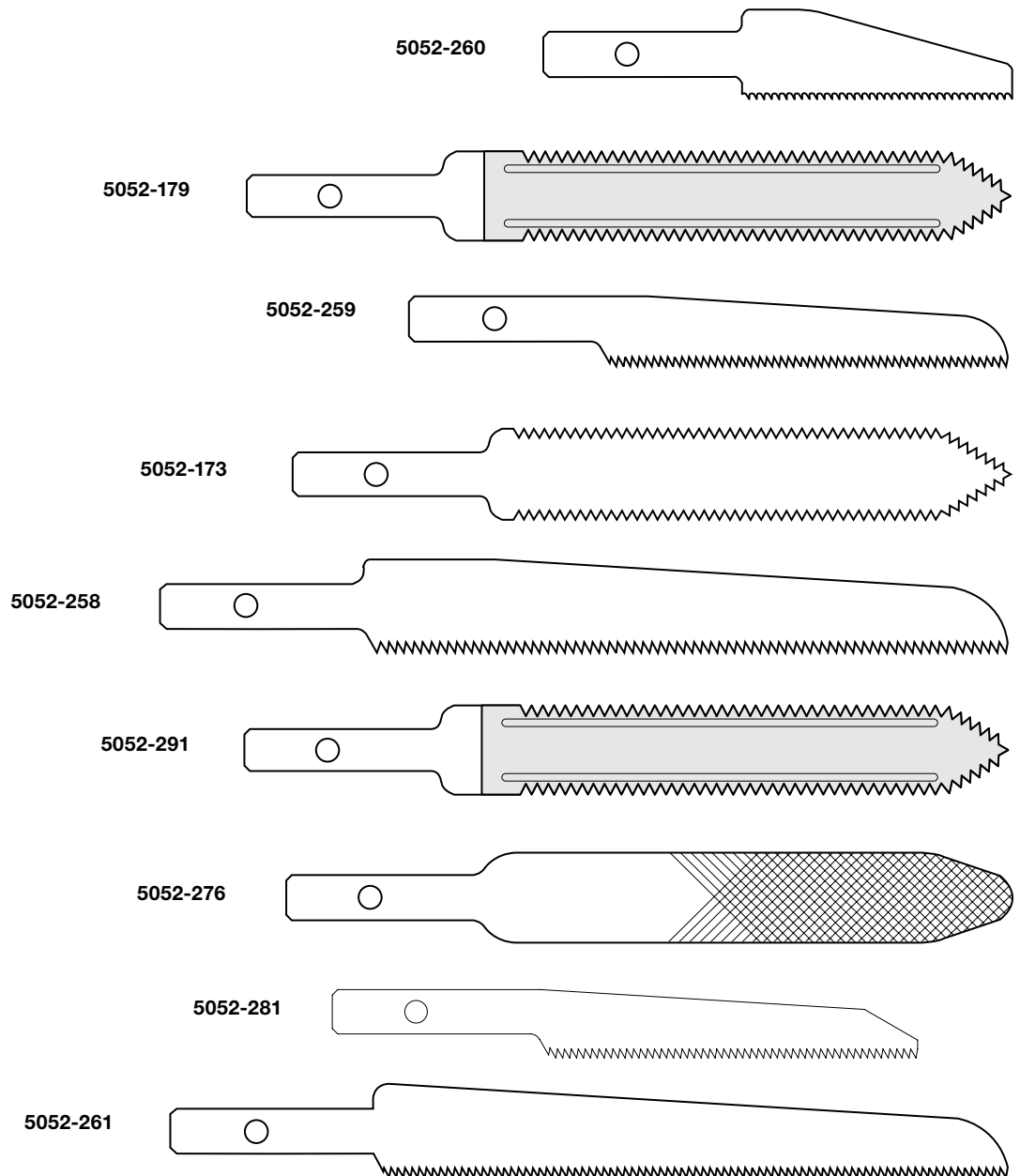

Shaded blades indicate coating.  
Products shown at actual size.

All products may not be available in all markets.



# Large Bone Reciprocating Blades

Indications for Use: Total Joint Arthroplasty  
& Large Bone Trauma



## Stryker Reciprocating Blades

For use with: Sytem 2000, System 4 & 5

Cat. No.	Width (mm)	Length (mm)	Material Thickness (mm)	Cut Thickness (mm)
5052-334	12.50	73.50	0.60	0.60
5052-332	12.00	76.00	0.80	0.80
5052-135	12.50	76.00	0.90	0.90
5052-333	12.00	76.00	1.30	1.30

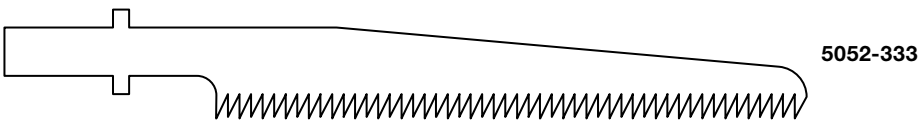
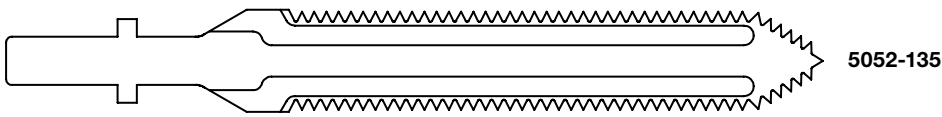
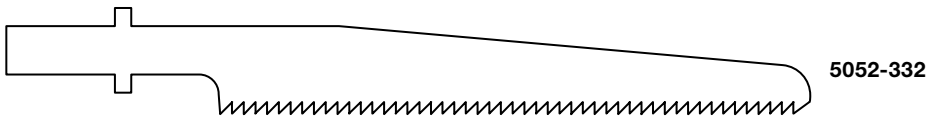
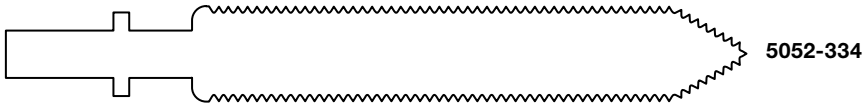

Products shown at actual size.

All products may not be available in all markets.

## Sagittal Saw Blades

Cat. No.	Tooth	Width (mm)	Length (mm)	Material Thickness (mm)	Cut Thickness (mm)
5023-144	Fine	5.50	18.50	0.4	0.6
5023-118	Fine	9.50	25.50	0.4	0.60
5023-130	Coarse	19.50	25.50	0.4	0.60
5023-131	Coarse	19.50	41.00	0.4	0.60
5023-132	Coarse	5.50	25.50	0.4	0.60
5023-133	Coarse	14.00	41.00	0.4	0.60
5023-137	Coarse	14.00	25.50	0.4	0.60
5023-138	Fine	9.50	25.50	0.40	0.60
5023-139	Fine	4.50	25.50	0.40	0.60
5023-140	Tapered/Fine	9.50	41.00	0.40	0.60
5023-141	Fine	6.00	34.00	0.40	0.60
5023-142	Fine	4.00	34.00	0.40	0.60
5023-143	Coarse	9.50	25.50	0.40	0.60
5023-244	Fine	4.00	6.00	0.40	0.60
5044-145	Fine	10.00	18.50	0.40	0.60
5023-247	Fine	9.50	25.50	0.60	0.60
5023-249	Fine	9.00	31.00	0.40	0.60

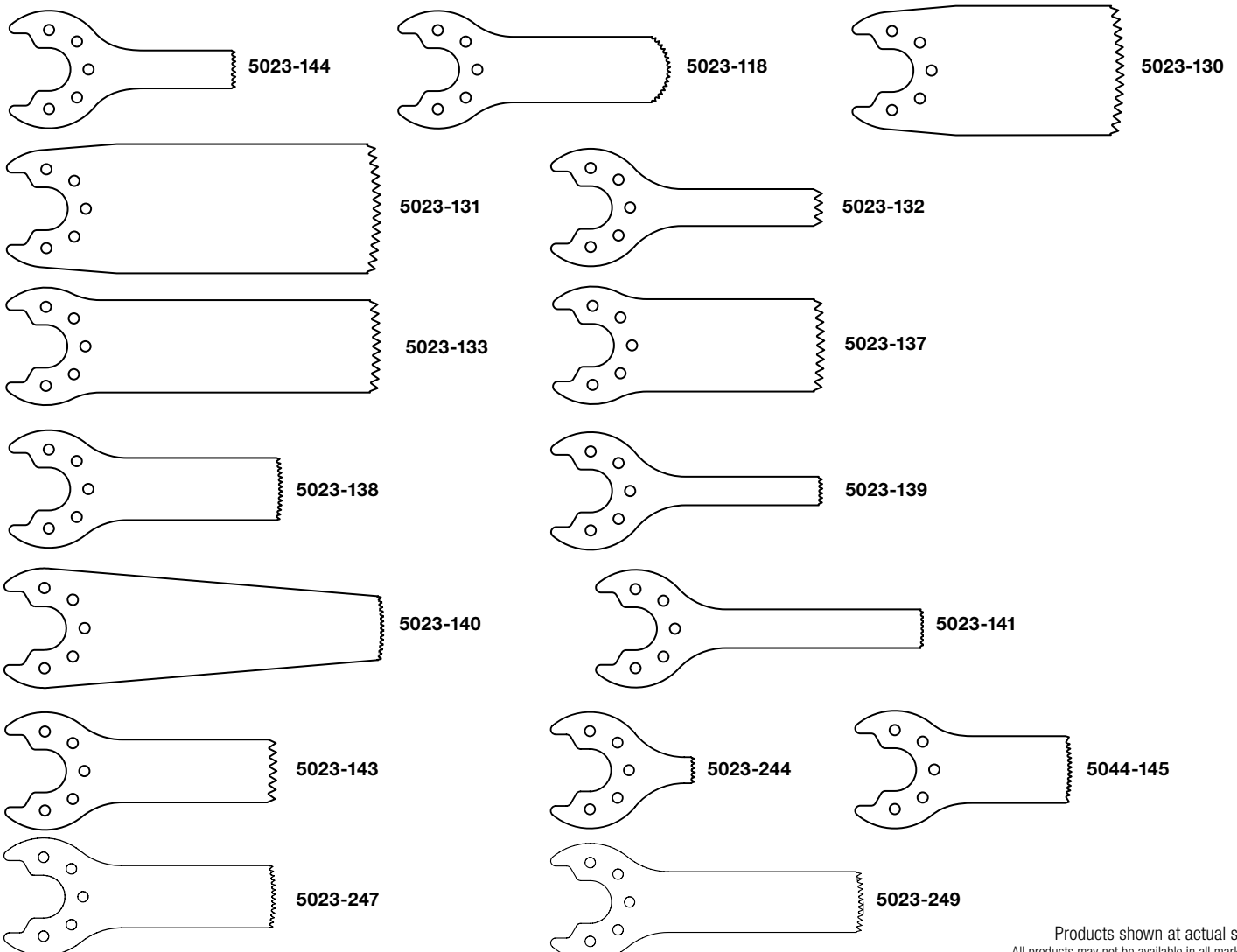

Products shown at actual size.  
All products may not be available in all markets.

# MicroPower® & Micro 100™ Sagittal Saw Blades



Indications for Use: Small Bone

## Angled Sagittal Saw Blades

Cat. No.	Tooth	Angle	Width (mm)	Length (mm)	Material Thickness (mm)	Cut Thickness (mm)
5023-128	Fine	70 Degree	9.50	7.50	0.40	0.60
5023-129	Fine	70 Degree	9.50	13.50	0.40	0.60
5023-134	Coarse	90 Degree	5.50	9.00	0.40	0.60
5023-135	Coarse	45 Degree	5.50	18.00	0.40	0.60
5023-136	Coarse	90 Degree	14.00	15.50	0.40	0.60

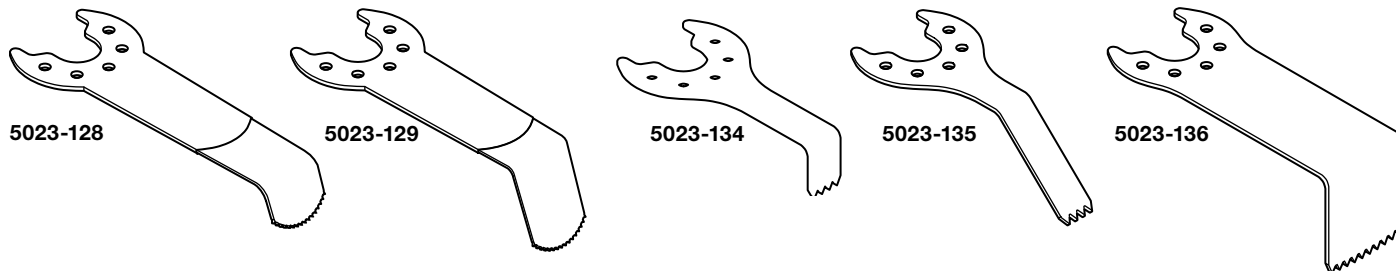

## ACL Blades

Cat. No.	Tooth	Edge	Depth Stop (mm)	Width (mm)	Length (mm)	Material Thickness (mm)	Cut Thickness (mm)
8703	Fine	Straight	8.0 with guide/12 without guide	9.50	25.50	0.40	0.60
5023-186	Coarse	Straight	None	8.50	38.00	0.40	0.74
5023-182	Coarse	Straight	None	19.00	41.00	0.40	0.69
5023-183	Fine	Straight	None	9.50	25.50	0.40	0.60
5023-184	Tapered/Fine	Straight	None	9.50	41.00	0.40	0.60
5023-185	Tapered/Coarse	Straight	None	6.50	30.00	0.40	0.60
C8803	Fine	Straight	8.0 with guide/12 without guide	9.40	41.00	0.38	0.60
C8804	Fine	Straight	8.0 Freehand	9.40	41.00	0.38	0.60
C8806	Fine	Straight	10.0 Freehand	9.40	41.00	0.38	0.60

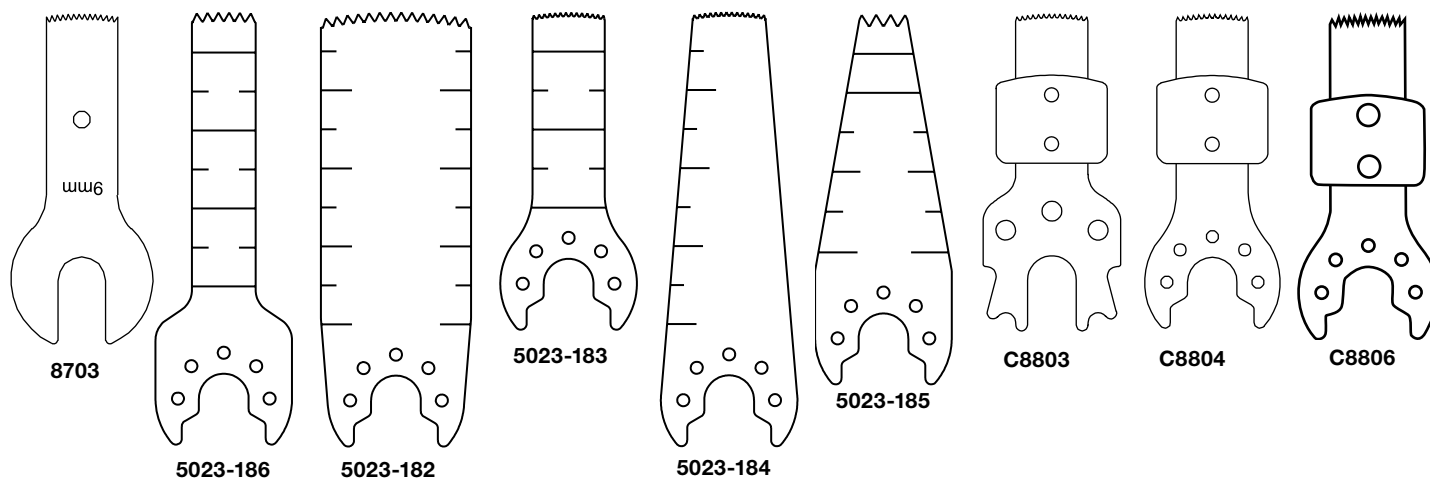

Products shown at actual size.  
All products may not be available in all markets.

## Dermabraders

Cat. No.	Tooth	Edge	Width (mm)	Length (mm)	Material Thickness (mm)
5023-055	Abrader	Straight	25.00	6.30	3.80
5023-056	Abrader	25 Degree	25.00	6.30	3.80
5023-057	Abrader	70 Degree	25.00	6.30	3.80

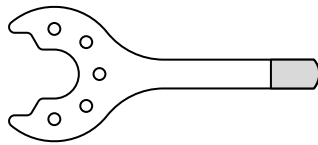

5023-055

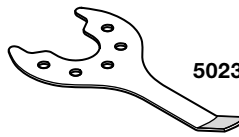

5023-056

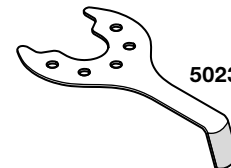

5023-057

## Graft Harvesting Blades

Cat. No.	Depth Stop (mm)	Width (mm)	Material Thickness (mm)	Cut Thickness (mm)
5023-405	20.00	16.50	0.40	5.00
5023-406	20.00	16.50	0.40	6.00
5023-407	20.00	16.50	0.40	7.00
5023-408	20.00	16.50	0.40	8.00
5023-409	20.00	16.50	0.40	9.00
5023-410	20.00	16.50	0.40	10.00
5023-411	20.00	16.50	0.40	11.00
5023-412	20.00	16.50	0.40	12.00
5023-413	20.00	16.50	0.40	13.00

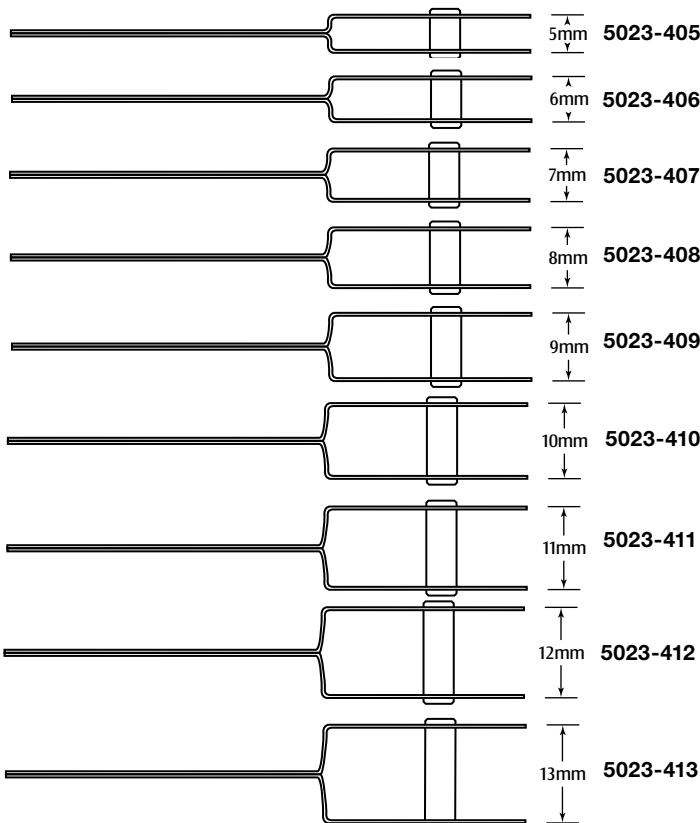

Products shown at actual size.  
All products may not be available in all markets.

# MicroPower® & Micro 100™ Oscillating Saw Blades



Indications for Use: Small Bone

## Oscillating Saw Blades

Cat. No.	Tooth	Edge	Width (mm)	Length (mm)	Material Thickness (mm)	Cut Thickness (mm)
5023-160	Fine	Straight	5.50	12.00	0.40	0.60
5023-161	Fine	Straight	10.00	12.00	0.40	0.60
5023-162	Fine	Straight	5.50	18.50	0.40	0.60
5023-163	Fine	Straight	10.00	18.50	0.40	0.60
5023-164	Fine	Straight	5.50	28.50	0.40	0.60
5023-165	Fine	Radial	10.00	28.50	0.40	0.60
5023-166	Fine	Radial	18.50	28.50	0.40	0.60
5023-169	Fine	Straight	10.00	35.00	0.40	0.60

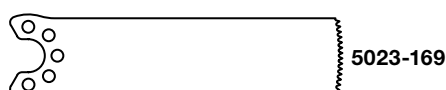
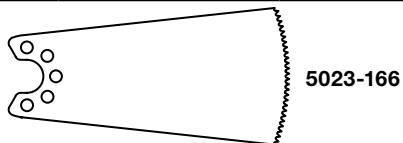
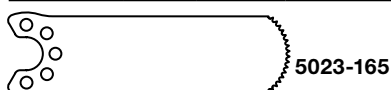
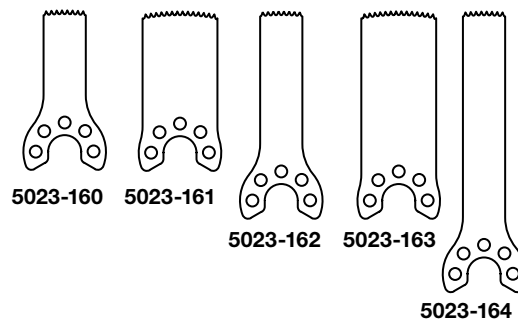

## Angled Oscillating Saw Blades

Cat. No.	Tooth	Edge	Width (mm)	Length (mm)	Material Thickness (mm)	Cut Thickness (mm)
5023-258	Fine	Radial/20 Degree	10.00	9.00	0.40	0.60
5023-259	Fine	Radial/20 Degree	10.00	13.50	0.40	0.60
5023-167	Fine	20 Degree	5.50	13.00	0.40	0.60
5023-168	Fine	Radial/20 Degree	10.00	13.00	0.40	0.60

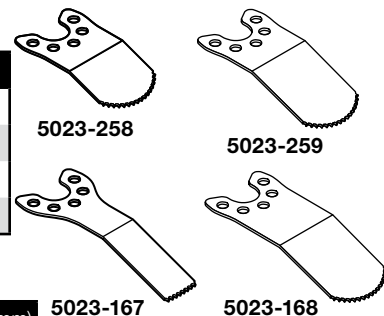

## Intra-Oral Blades \*Not for use with Micro 100™

Cat. No.	Tooth	Width (mm)	Length (mm)	Material Thickness (mm)	Cut Thickness (mm)	Cutting Depth (mm)
5023-101*	Coarse	11.50	7.00	0.40	0.60	7.00
5023-102*	Coarse	11.50	12.00	0.40	0.60	12.00
5023-103*	Coarse	9.00	12.00	0.40	0.60	12.00
5023-104*	Coarse	5.00	12.00	0.40	0.60	12.00

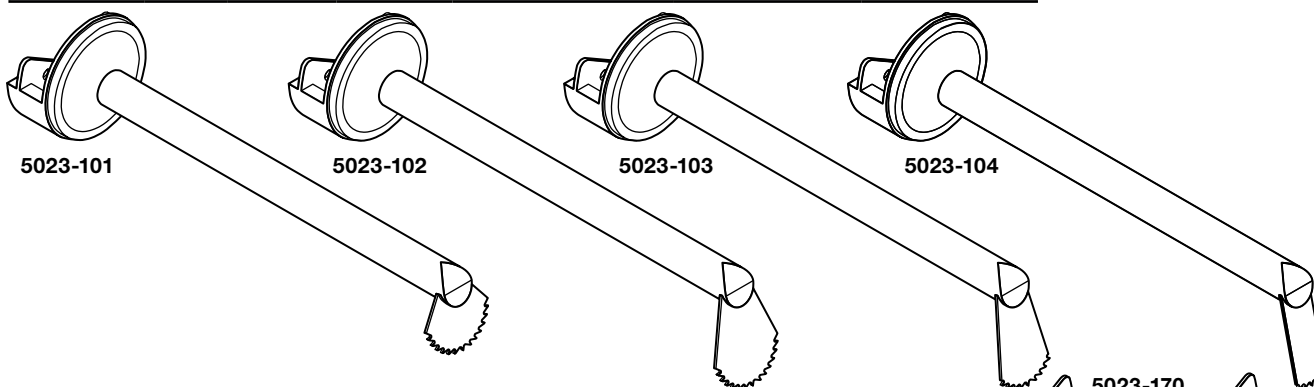

## Crescentic Blades

Cat. No.	Tooth	Width (mm)	Length (mm)	Material Thickness (mm)	Cut Thickness (mm)	Cutting Depth (mm)
5023-170	Fine	9.0	12.00	0.40	0.60	12.00
5023-171	Fine	13.5	25.50	0.40	0.60	25.50
5023-172	Fine	18.0	32.00	0.40	0.60	32.00
5023-176	Fine	13.5	32.00	0.40	0.60	32.00

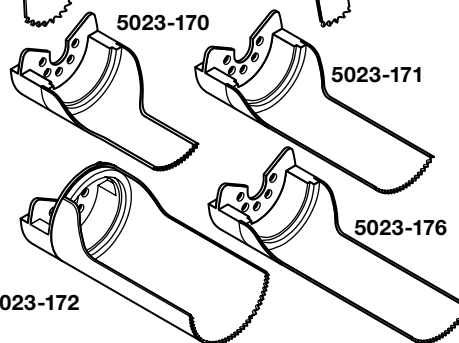

Products shown at actual size.  
All products may not be available in all markets.

## Reciprocating Rasp

Cat. No.	Shank	Width (mm)	Length (mm)
5053-080	Round	5.50	9.50
5053-081	Round	6.50	12.50
5053-082	Round	5.50	9.50
5053-083	Round	6.50	12.50
5053-084	Round	5.30	24.50
5053-085	Round	9.50	30.50

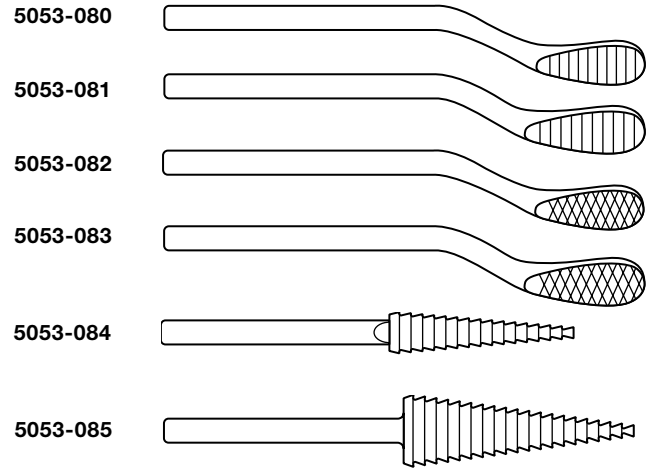

## Reciprocating Saw Blades

Cat. No.	Shank	Length (mm)	Material Thickness (mm)
5053-220	Flat	25.50	0.40
5053-221	Flat	38.00	0.40
5053-054	Round	25.00	0.60
5053-122	Flat	25.50	0.25
5053-126	Round	28.00	0.60

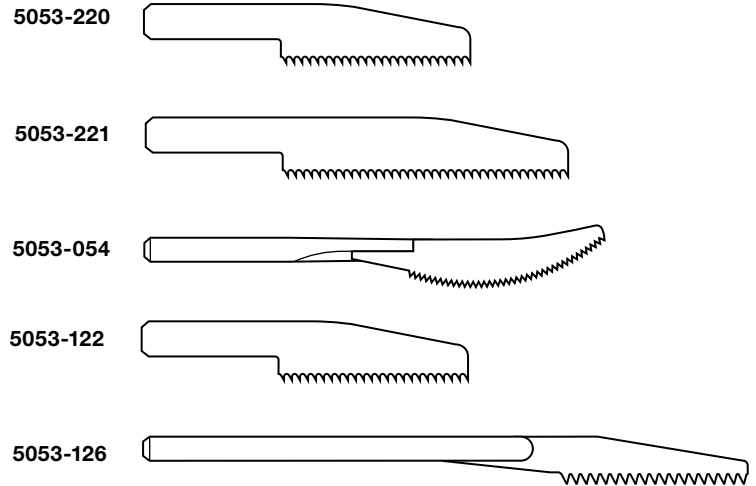

## Depth Limiting Reciprocating Saw Blades

Cat. No.	Shank	Length (mm)	Material Thickness (mm)	Cut Depth (mm)
5053-050	Round	7.00	0.60	5.00
5053-051	Round	17.00	0.60	4.00
5053-052	Round	23.00	0.60	5.00
5053-053	Round	25.00	0.60	7.00

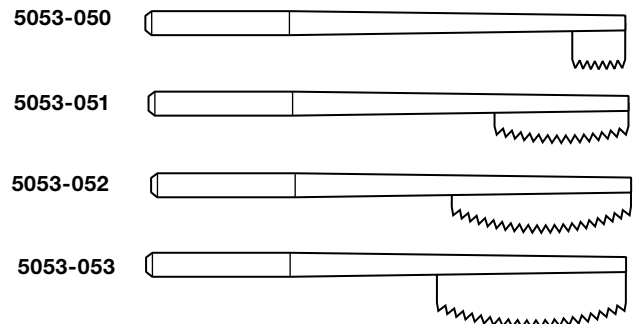

Products shown at actual size.  
All products may not be available in all markets.

# MicroPower® & Micro 100™ Small Bone Burs



Indications for Use: Small Bone

MicroPower & Micro 100 Bur Guards	Round Fluted												
	Flutes (mm)	4.00	6.00	6.00	8.00	6.00	8.00	6.00	8.00	8.00	10.00	10.00	10.00
	Diameter (mm)	0.50	1.00	1.50	1.80	2.00	2.30	2.40	3.00	4.00	5.00	6.00	6.50
1375-012				5091-222	5091-221	5091-224	5091-223	5091-225	5091-226	5091-228	5091-230	M60R	5091-232
1375-011			5092-220	5092-222	L18R	5092-224	L23R		5092-226	5092-228	5092-230	L60R	5092-232
1375-023		5093-221	5093-220			5093-224			5093-226	5093-228	5093-230	X60R	5093-232
1387-022									5092-236				

MicroPower & Micro 100 Bur Guards	Fine Round Diamond						
	Diameter (mm)	1.00	2.00	3.00	4.00	5.00	6.00
1375-012			5091-260		5091-264	5091-268	M60D
1375-011		L10D	5092-260	5092-262	5092-264	5092-266	5092-268
1375-023		X10D	5093-260	5093-262	5093-264	5093-266	

MicroPower & Micro 100 Bur Guards	Wire Pass Burs			
	Flutes (mm)	2.00	2.00	2.00
	Diameter (mm)	1.00	1.50	2.00
	Length (mm)	19.00	19.00	19.00
1375-035		5090-247	5090-248	5090-249
1375-036		5090-247	5090-248	5090-249
1375-011		5092-247		
1375-032		5092-247		
1375-012		5091-247	5091-248	5091-249

MicroPower & Micro 100 Bur Guards	Swanson Reamers				
	Flutes (mm)	4.00	6.00	6.00	8.00
	Diameter (mm)	2.00	3.00	4.00	5.00
1375-012		5091-242	5091-243	5091-244	5091-245

MicroPower & Micro 100 Bur Guards	Dermabraders - Fine Diamond					N/A	N/A	N/A	N/A	
	Diameter (mm)	2.00	4.00	6.00	4.00	4.00	7.00	12.00	10.00	2.00
	Bur Head Length (mm)				8.00	15.00	15.00	15.00	15.00	19.00
1375-012		5091-260	5091-264	5091-268	5091-270	5091-080	5091-081	5091-082	5091-083	
1375-011					5092-270					

Bur Shank Diameter 2.34mm (0.82")

Products shown at actual size.

All products may not be available in all markets.

	Straight Side Cutting Burs														
		Flutes (mm)	6.00	6.00	6.00	6.00	6.00	6.00	6.00	6.00	6.00	6.00	6.00	6.00	
		Diameter (mm)	1.00	1.10	1.20	1.30	1.30	1.50	1.50	1.50	1.60	1.60	1.70	1.70	1.70
MicroPower & Micro 100 Bur Guards		Bur Head Length (mm)	5.00	5.00	4.90	9.90	9.90	5.10	8.00	10.00	4.30	7.50	12.00	9.90	9.90
1375-012		5091-201	M10S	5091-216		M13S	5091-204		5091-202	5091-217	M15S			M17S	
1375-011					L13S		5092-204					5092-203	L17S		
1375-020												5092-203			
1375-035 & 1375-036								5089-208							

	Tapered Side-cutting							
		Diameter (mm)	0.80	1.20	1.20	1.20	1.60	1.60
MicroPower & Micro 100 Bur Guards		Bur Head Length (mm)	4.90	9.90	3.70	9.90	21.60	4.30
1375-012		5091-215	M12T	5091-219			M20T	5091-218
1375-011					L12T			

	Tapered Side-cutting						
		Diameter (mm)	1.60	2.00	2.00	2.00	2.00
MicroPower & Micro 100 Bur Guards		Bur Head Length (mm)	21.90	7.50	19.00	7.50	19.00
1375-012				5091-206	5091-214		
1375-011			L20T			5092-206	5092-214

	Barrel Burs			
		Flutes (mm)	6.00	6.00
		Diameter (mm)	2.00	4.00
MicroPower & Micro 100 Bur Guards		Bur Head Length (mm)	10.00	10.00
1375-012		5091-252	5091-254	
1375-011		5092-252	5092-254	

	Oval Burs					
		Flutes (mm)	8.00	8.00	8.00	8.00
		Diameter (mm)	4.00	5.50	4.00	5.50
MicroPower & Micro 100 Bur Guards		Bur Head Length (mm)	8.00	10.0	7.9	10.0
1375-012		5091-236	5091-238	M40B	M55B	
1375-011		5092-236	5092-238	L40B	L55B	
1375-023		5093-236	5093-238	X40B	X55B	
1387-022		5092-236				

Products shown at actual size.  
All products may not be available in all markets.





# MicroPower® & Micro 100™ Small Bone Burs



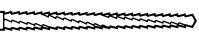

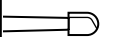



Indications for Use: Small Bone

	<b>Lindemann Burs</b>	
	Flutes (mm)	4.00
	Diameter (mm)	1.60
<b>MicroPower &amp; Micro 100 Bur Guards</b>	Bur Head Length (mm)	31.00
1375-012		5091-212

	<b>Cylindrical</b>	
	Flutes (mm)	2.00
	Diameter (mm)	3.00
<b>MicroPower &amp; Micro 100 Bur Guards</b>	Bur Head Length (mm)	4.00
1375-011		5092-291

	<b>Cone Burs</b>		
	Flutes (mm)	8.00	12.00
	Diameter (mm)	4.50	4.50
<b>MicroPower &amp; Micro 100 Bur Guards</b>	Bur Head Length (mm)	12.00	12.00
1375-012		M45C	
1375-011			L45C

	<b>Tapered Cross-cut Fissure Burs</b>			
	Flutes (mm)	701 Type	702 Type	703 Type
	Diameter (mm)	1.20	1.60	2.10
<b>MicroPower &amp; Micro 100 Bur Guards</b>	Bur Head Length (mm)	2.30	3.80	4.90
1375-012		5091-271	5091-272	5091-213
1375-011		5092-271	5092-272	5092-273

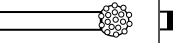
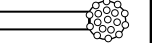
	<b>Heavy Grit Diamond-Microbur. X-Long</b>					
<b>MicroPower &amp; Micro 100 bur guards</b>	Diameter (mm0)	2.00	3.00	4.00	5.00	6.00
	Grit	60-70	60-70	40-45	40-45	40-45
1375-033 & 1375-023		5093-282	5093-283	5093-284	5093-285	
1375-032 & 1375-011			5092-283	5092-284	5092-285	5092-286

Products shown at actual size.  
All products may not be available in all markets.

## C-Wires

Cat. No.	Tip	Diameter	Length	Quantity
5050-041	Spade	.028" (.70mm)	5" (13.00cm)	50 per Pkg.
5050-042	Spade	.035" (.90mm)	5" (13.00cm)	50 per Pkg.
5050-043	Spade	.045" (1.10mm)	5" (13.00cm)	50 per Pkg.
5050-044	Spade	.062" (1.60mm)	5" (13.00cm)	50 per Pkg.
5050-046	Trocar	.028" (.70mm)	5" (13.00cm)	50 per Pkg.
5050-047	Trocar	.035" (.90mm)	5" (13.00cm)	50 per Pkg.
5050-048	Trocar	.045" (1.10mm)	5" (13.00cm)	50 per Pkg.
5050-049	Trocar	.062" (1.60mm)	5" (13.00cm)	50 per Pkg.

Note: To order C-Wires in a box of 5, instead of 50 per package, please order using catalog number 5050-2XX. For example, 5051-241 instead of 5050-041.

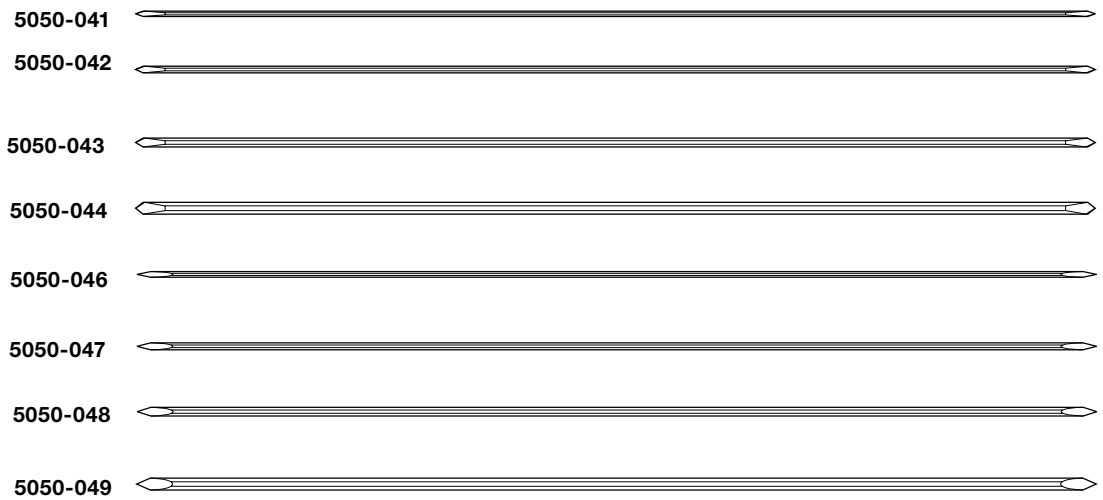

## Staplizer® Cartridges

Cat. No.	Width (mm)	Length (mm)
7707-03	7.00	7.00
7710-03	7.00	10.00
7007-03	10.00	7.00
7010-03	10.00	10.00
7015-03	10.00	15.00
7307-03	13.00	7.00
7310-03	13.00	10.00
7315-03	13.00	15.00
7320-03	13.00	20.00
7610-03	16.00	10.00
7615-03	16.00	15.00
7620-03	16.00	20.00
7625-03	16.00	25.00

Note: 3 cartridges per Pkg.  
5 Staples per cartridge.

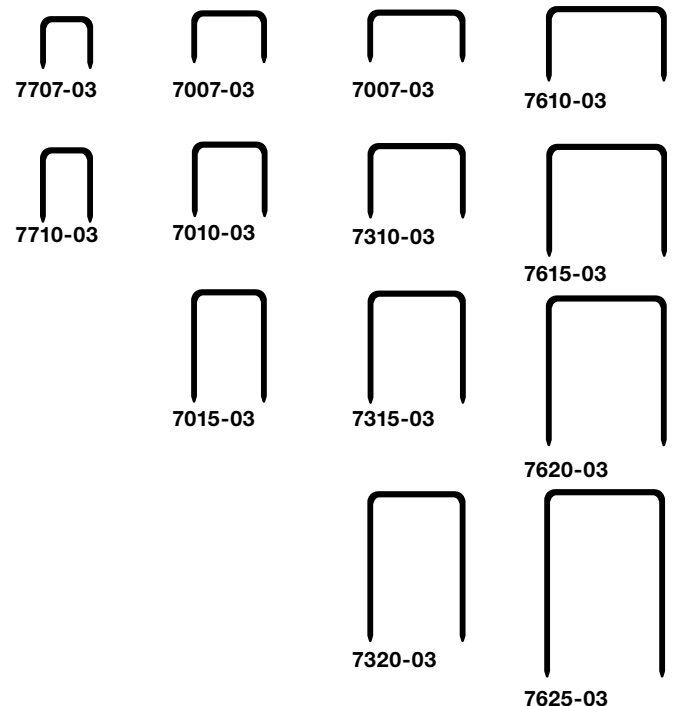

Products shown at actual size.  
All products may not be available in all markets.

# E9005 ENT Shaver Blades

Indications for Use: Sinus Surgery



Ideal for aggressive removal of ethmoid bone, cartilage and soft tissue



Ideal for aggressive removal of ethmoid bone, cartilage and soft tissue



Ideal for removal of soft tissue

Products not shown at actual size.  
All products may not be available in all markets.

## For use with:

E9005 High Speed Shaver

### MicroXcisor® Blade

Cat. No.

4.2mm, Irrigated, 10.5cm Working Length, 6/Box ..... N9330

### Lynx® Blade

4.2mm, Irrigated, 10.5cm Working Length, 6/Box ..... N9150

### RhinoTec® Cuda® Blade

4.2mm, Bendable to 30°, Irrigated, 10.5cm Working Length, 6/Box ..... E9350

3.7mm, Bendable to 30°, Irrigated, 10.5cm Working Length, 6/Box ..... E9351

4.2mm, Bendable to 45°, 10.5cm Working Length, 6/Box ..... A9350

4.2mm, Irrigated, 10.5cm Working Length, 6/Box ..... N9210

3.5mm, 7.6cm Working Length, 6/Box ..... C9952

2.9mm, 7.6cm Working Length, 6/Box ..... C9951

2.0mm, 7.6cm Working Length, 6/Box ..... C9950

## Rhinotec® Gator® Blade

	Cat. No.
4.2mm, Bendable to 30°, Irrigated, 10.5cm Working Length, 6/Box.....	E9360
3.7mm, Bendable to 30°, Irrigated, 10.5cm Working Length, 6/Box.....	E9361
4.2mm, Bendable to 45°, 10.5cm Working Length, 6/Box.....	A9360
4.2mm, Irrigated, 10.5cm Working Length, 6/Box.....	N9220
3.5mm, 7.6cm Working Length, 6/Box.....	C9962
2.9mm, 7.6cm Working Length, 6/Box.....	C9961
2.0mm, 7.6cm Working Length, 6/Box.....	C9960

## Head & Neck Blade

4.2mm, 11.5cm Working Length, 6/Box.....	N9321
3.5mm, 7.0cm Working Length, 6/Box.....	N9320

## Laryngeal Blade

3.7mm, Bendable to 45°, 20.0cm Working Length, 6/Box.....	E9363
---	-------



Ideal for aggressive removal of soft tissue, cartilage and thin bone



Ideal for the most gentle removal of soft tissue



Ideal for removal of soft tissue in laryngeal procedures

Products not shown at actual size.  
All products may not be available in all markets.

# E9005 ENT Shaver Blades

Indications for Use: Sinus Surgery



Ideal for aggressive removal of hard bone and cartilage



45° fixed curve (pre-bent)  
Ideal for aggressive removal of hard bone



Ideal for less aggressive removal of hard bone Ideal for rhinoplasty

## Rhinotec® Vortex® Router

Cat. No.

3.5mm, Hooded, 7.6cm Working Length, 6/Box ..... C9991

2.9mm, Hooded, 7.6cm Working Length, 6/Box ..... C9990

## Curved Vortex Router

4.5mm, 45° Pre-Bent, 11.5cm Working Length, 6/Box..... N9375

## Otolaryngology Bur

4.0mm, Hooded, 10.8cm Working Length, 6/Box ..... N9390

Products not shown at actual size.  
All products may not be available in all markets.

**Rhinotec® Spherical Bur, Hooded**

Cat. No.

4.5mm, Hooded, 10.8cm Working Length, 6/Box ..... N9380

3.5mm, Hooded, 7.6cm Working Length, 6/Box ..... C9912

2.9mm, Hooded, 7.6cm Working Length, 6/ Box .....C9911

**Rhinotec® Spherical Bur, Unhooded**

3.5mm, Hooded, 7.6cm Working Length, 6/Box ..... N9382

**Rhinotec Spherical Diamond Bur, Hooded**

3.5mm, Hooded, 10.8cm Working Length, 6/Box ..... N9385



Ideal for aggressive removal of hard bone and cartilage



Ideal for less aggressive removal of hard bone and cartilage



Ideal for less aggressive removal of hard bone and cartilage

Products not shown at actual size.  
All products may not be available in all markets.

# E Burs

Indications for Use: Otology, Spine & Neuro



\*These burs may be used with multiple bur guard options to change the working length of the bur.

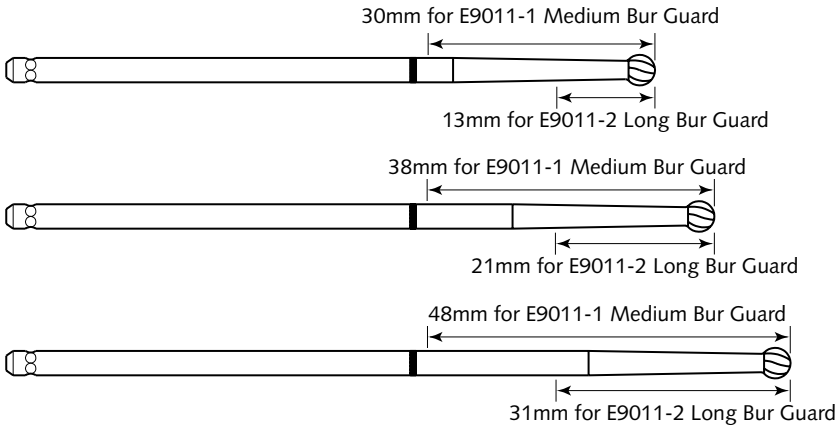

E9010 Bur Guard No.	Round Fluted						
	Flutes (mm)	4.00	4.00	6.00	6.00	6.00	8.00
	Diameter (mm)	0.50	0.70	1.00	1.50	2.00	2.50
E9011-1 or E9011-2			E8007	E8010	E8015	E8020	E8025
E9011-1 or E9011-2		E8105		E8110	E8115	E8120	E8125
E9011-1 or E9011-2		E8205	E8207	E8210	E8215	E8220	E8225

Bur Guard No.	LSO Round Fluted				
	Flutes (mm)	8.00	8.00	8.00	10.00
	Diameter (mm)	3.00	4.00	5.00	6.50
E9011-1 or E9011-2		E8030LSO	E8040LSO	E8050LSO	E8065LSO
E9011-1 or E9011-2		E8130LSO	E8140LSO	E8150LSO	E8165LSO
E9011-1 or E9011-2		E8230LSO	E8240LSO		E8265LSO

E9010 Bur Guard No.	Fine Round Diamond										
	Diameter (mm)	0.50	0.70	1.00	1.50	2.00	2.50	3.00	4.00	5.00	6.00
E9011-1 or E9011-2									E6040		
E9011-1 or E9011-2		E6105		E6110	E6115	E6120	E6125	E6130	E6140	E6150	E6160
E9011-1 or E9011-2		E6205	E6207	E6210	E6215	E6220	E6225	E6230	E6240	E6250	



E9010 Bur Guard No.	Coarse Round Diamond									
	Diameter (mm)	1.00	1.50	2.00	2.50	3.00	4.00	5.00	6.00	7.00
E9011-1 or E9011-2				E5120		E5160	E5140	E5150	E5130	E5170
E9011-1 or E9011-2		E5210	E5215	E5220	E5225	E5230	E5240	E5050		

Products shown at actual size.

All products may not be available in all markets.

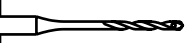
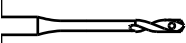
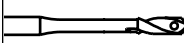

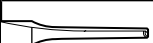
\*These burs may be used with multiple bur guard options to change the working length of the bur.

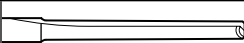
	<b>Wirepass burs</b>			
	diameter (mm)	1.00	1.50	2.00
<b>E9010 Bur Guard No</b>	length (mm)	38.00	38.00	38.00
E9011-1 or E9011-2		E4110	E4115	E4120

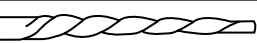
	<b>Neuro Burs</b>			
	Flutes (mm)	1.00	2.00	2.00
	Diameter (mm)	1.80	2.20	3.00
<b>E9010 Bur Guard No.</b>	Bur Head Length (mm)	11.00	16.00	25.00
E9011-7 or 7020-017		7021-713		
E9011-8 or 7020-018			7021-815	
7020-019				7021-917

	<b>Helical Bur for E9010 Drill</b>	
<b>E9010 Bur Guard No.</b>	Bur Head Length (mm)	25.00
E9011-9, E9011-2 and 7020-012		7021-960

	<b>E9010 Lindemann Bur</b>	
	Diameter (mm)	1.60
<b>E9010 Bur Guard No.</b>	Bur Head Length (mm)	31.00
E9011-1		E4217

	<b>E9010 Side Cutting Burs</b>		
	Diameter (mm)	0.80	2.00
<b>E9010 Bur Guard No.</b>	Bur Head Length (mm)	4.90	7.50
E9011-1		E4208	E4220









Products shown at actual size.  
All products may not be available in all markets.















# UltraPower® Burs

Indications for Use: Otology  
(Round Burs Only), Spine & Neuro









UltraPower Bur Guard No.	Round Fluted									
	Flutes (mm)	4.00	6.00	6.00	6.00	8.00	8.00	8.00	8.00	8.00
UltraPower Bur Guard No.	Diameter (mm)	0.50	1.00	1.50	2.00	2.50	3.00	4.00	5.00	6.00
7020-010					7021-024	7021-025	7021-026	7021-027	7021-028	7021-029
7020-011			7021-122	7021-123	7021-124	7021-125	7021-126	7021-127	7021-128	7021-129
7020-012		7021-220	7021-222	7021-223	7021-224	7021-225	7021-226	7021-227	7021-228	7021-229
7020-013			7021-322	7021-323	7021-324	7021-325	7021-326	7021-327	7021-328	7021-329
7020-014							7021-426	7021-427	7021-428	7021-429
7020-015							7021-526		7021-528	7021-529





UltraPower Bur Guard No.	Round Fluted					
	Flutes (mm)	10	10	10	10	10
UltraPower Bur Guard No.	Diameter (mm)	6.5	7.5	8.0	9.0	10.0
7020-010		7021-030	7021-031	7021-034	7021-032	7021-033
7020-011		7021-130	7021-131	7021-134	7021-132	7021-133
7020-012		7021-230	7021-231		7021-232	7021-233
7020-013			7021-331		7021-332	7021-333
7020-014			7021-431		7021-432	7021-433
7020-015			7021-531		7021-532	7021-533
7020-016			7021-631		7021-632	7021-633



UltraPower Bur Guard No.	Fine Round Diamond							
	Diameter (mm)	1.0	2.0	3.0	4.0	5.0	6.0	7.0
7020-010			7021-062	7021-063	7021-064	7021-065	7021-066	
7020-011		7021-161	7021-162	7021-163	7021-164	7021-165	7021-166	7021-167
7020-012		7021-261	7021-262	7021-263	7021-264	7021-265	7021-266	7021-267
7020-013		7021-361	7021-362	7021-363	7021-364	7021-365	7021-366	7021-367

Products shown at actual size.

All products may not be available in all markets.

	Coarse Round Diamond							
UltraPower Bur Guard No.	Diameter (mm)	1.00	2.00	3.00	4.00	5.00	6.00	7.00
7020-010					7021-074	7021-075		7021-077
7020-011		7021-171	7021-172	7021-173	7021-174	7021-175	7021-176	7021-177
7020-012			7021-272	7021-273	7021-274	7021-275	7021-276	7021-277
7020-013		7021-371	7021-372	7021-373	7021-374	7021-375	7021-376	7021-377
7020-014					7021-474			

	Side Cutting, Burs					
	Flutes (mm)	8.00	8.00	8.00	8.00	8.00
	Diameter (mm)	5.00	5.00	7.50	7.50	7.50
UltraPower Bur Guard No.	Bur Head Length (mm)	8.00	17.00	5.00	9.00	28.00
7020-012		7021-202			7021-206	7021-207
7020-013		7021-302	7021-303	7021-305		
7020-014						7021-427





	Side Cutting Burs			
	Flutes (mm)	8.00	8.00	12.00
	Diameter (mm)	9.00	9.00	10.50
UltraPower Bur Guard No.	Bur Head Length (mm)	5.00	9.00	11.00
7020-012				7021-210
7020-013			7021-309	7021-310
7020-014		7021-408	7021-409	
7020-015			7021-509	



Products shown at actual size.  
All products may not be available in all markets.



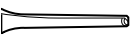
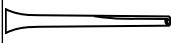

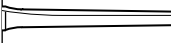
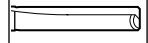
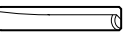
# UltraPower® Burs

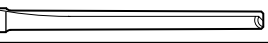
Indications for Use: Otology  
(Round Burs Only), Spine & Neuro



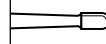

Ultrapower Bur Guard No.	Side Cutting Burs								
	Flutes (mm)	1.00	1.00	1.00	2.00	2.00	2.00	2.00	2.00
	Diameter (mm)	1.50	1.8	2.00	1.20	2.20	2.20	3.00	3.00
Ultrapower Bur Guard No.	Bur Head Length (mm)	8.00	11.00	16.0	6.00	16.00	23.00	20.00	25.00
7020-010		7021-012	7021-013		7021-043	7021-015			
7020-011		7021-112	7021-113	7021-114	7021-143	7021-115	7021-116		
7020-012			7021-713	7021-214	7021-243	7021-815			7021-917
7020-013				7021-314		7021-315		7021-301	



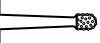

Ultrapower Bur Guard No.	Side Cutting Burs		
	Flutes (mm)	2.00	6.00
	Diameter (mm)	3.00	1.50
Ultrapower Bur Guard No.	Bur Head Length (mm)	36.00	4.90
7020-011			7021-119
7020-012		7021-218	
7020-013		7021-318	

Ultrapower Bur Guard No.	Fluted Cylindrical Burs				
	Flutes (mm)	2.00	2.00	2.00	2.00
	Diameter (mm)	1.80	1.80	2.20	3.00
7020-010				7021-036	7021-037
7020-011				7021-136	7021-137
7020-012			7021-235	7021-236	7021-237
7020-013		7021-338	7021-335	7021-336	7021-337
7020-014					7021-437

Products shown at actual size.

All products may not be available in all markets.

		Fine Diamond Cylindrical Burs	
Ultrapower Bur Guard No.	Diameter (mm)		
7020-012		1.90	3.00
7020-013		7021-378	7021-379

		Fluted Acorn Burs			
					
		Flutes (mm)			
		8.00			
Ultrapower Bur Guard No.	Diameter (mm)	5.00	6.00	7.50	9.00
7020-010			7021-081		7021-083
7020-011			7021-181	7021-182	7021-183
7020-012		7021-280	7021-281	7021-282	7021-283
7020-013		7021-380	7021-381	7021-382	7021-383
7020-014				7021-482	7021-483
7020-015			7021-581		7021-583
7020-016			7021-681		7021-683

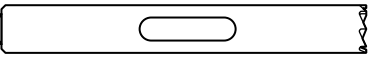
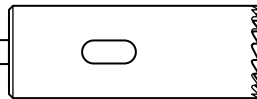
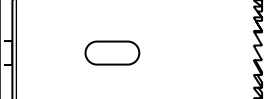
		Trephine Burs			
					
Ultrapower Bur Guard No.	Diameter (mm)	3.20	5.30	10.70	13.50
7020-010			7021-051		
7020-012		7021-250		7021-252	7021-253

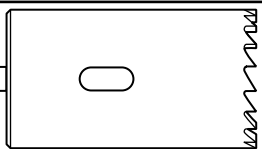
		Trephine Burs
		
Ultrapower Bur Guard No.	Diameter (mm)	16.80
7020-012		7021-255



Products shown at actual size.



All products may not be available in all markets.

# UltraPower® Burs

Indications for Use: Otology  
(Round Burs Only), Spine & Neuro



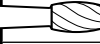

		Wire Pass Burs		
				
	Flutes (mm)	2.00	2.00	2.00
UltraPower Bur Guard No.	Diameter (mm)	1.00	1.50	2.00
7020-010		7021-040	7021-041	7021-042
7020-011		7021-140	7021-141	7021-142

		Oval Fluted Burs	
			
	Flutes (mm)	8.00	8.00
	Diameter (mm)	4.00	5.50
UltraPower Bur Guard No.	Bur Head Length (mm)	8.00	10.00
7020-010		7021-095	7021-096
7020-011		7021-195	7021-196
7020-012		7021-295	7021-296
7020-013		7021-395	7021-396

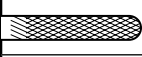
		Fluted Frustrum Bur
		
	Flutes (mm)	8.00
UltraPower Bur Guard No.	Diameter (mm)	6.50
7020-013		7021-391

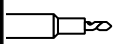
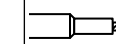
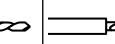
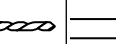
		Carbide Metal Cutting Burs
		
	Diameter (mm)	3.20
UltraPower Bur Guard No.	Bur Head Length (mm)	15.20
7020-010		7021-094
7021-012		7021-294

		Wire Pass Burs – Depth Limiting			
					
	Diameter (mm)	1.10	1.10	1.10	1.50
UltraPower Bur Guard No.	Depth (mm)	3.50	5.00	9.00	7.00
7020-011		7021-141-35	7021-141-50	7021-141-90	7021-145-70

		Carbide Metal Cutting Burs
		
	Flutes (mm)	8.00
	Diameter (mm)	6.00
UltraPower Bur Guard No.	Bur Head Length (mm)	4.00
7020-012		7021-297

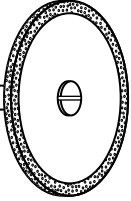
		Fine Diamond Wheels for Metal Cutting
		
UltraPower Bur Guard No.	Diameter (mm)	25.40
7020-010		7021-092
7020-012		7021-292
7020-013		7021-392
7020-014		7021-492

Products shown at actual size.  
All products may not be available in all markets.

Working Length (mm)	Fluted Round Burs											
	Flutes (mm)	4.00	4.00	6.00	6.00	6.00	6.00	8.00	8.00	8.00	10.00	10.00
Diameter (mm)	0.50	0.70	1.00	1.50	2.00	2.50	2.50	3.00	4.00	5.00	6.50	
30			5056-173	5056-174	5056-177	5056-178	5056-179		5056-116	5056-119	5056-118	5056-117
38									5056-128	5056-127	5056-126	5056-125
48		5056-166	5056-165	5056-164	5056-140	5056-142		5056-149	5056-146	5056-145	5056-144	

Working Length (mm)	Fine Diamond Round Burs									
	Diameter (mm)	0.50	0.70	1.00	1.50	2.00	3.00	4.00	5.00	6.00
30								5056-168	5056-147	5056-167
38								5056-148	5056-150	
48		5056-161	5056-160	5056-158	5056-163	5056-162	5056-159	5056-152		

Working Length (mm)	Coarse Diamond Round Burs						
	Diameter (mm)	1.00	2.00	3.00	4.00	5.00	6.00
48		5056-958	5056-962	5056-959	5056-952	5056-950	5056-967

Working Length (mm)	Deep Access Burs					
	Flutes (mm)	10.00	12.00	6.00		
Diamond				Fine	Fine	
Diameter (mm)	3.00	4.00	5.50	3.00	4.00	
90		5056-170	5056-171		5056-175	5056-176
95				5056-172		

Working Length (mm)	Wire Pass Burs			
	Diameter (mm)	1.00	1.50	2.00
Bur Head Length (mm)	19.00	19.00	19.00	
38		5056-184	5056-185	5056-186

Working Length (mm)	80 Grit Dermabrasion Burs				
	Diameter (mm)	4.00	7.00	12.00	10.00
Bur Head Length (mm)	15.00	15.00	15.00	15.00	
30		5056-080	5056-081	5056-082	5056-083

Products shown at actual size.  
All products may not be available in all markets.

# Cebotome® Burs & Metal Cutting Accessories

Indication for Use: Large Bone Revisions Surgery



Cebotome® Burs								
Flutes (mm)	2.00	2.00	2.00	10.00	10.00	10.00	6.00	6.00
Diameter (mm)	5.00	6.00	7.00	7.00	8.00	9.00	8.50	10.00
	5052-181	5052-182	5052-183	5052-184	5052-185	5052-186	5052-187	5052-188

Cebotome Burs				
Flutes (mm)	6.00	10.00	6.00	8.00
Diameter (mm)	5.00	10.00	7.00	8.50
	5052-189	5052-190	5052-191	5052-192

Cebotome Metal Cutting Wheels		
Grit (mm)	150.00	150.00
Diameter (mm)	25.40	25.40
	5052-125	5052-126

Cebotome Diamond Metal Cutting Burs		
Diameter (mm)	3.2	3.2
Diamond	Flat	Round
	5052-144	5052-145

Products shown at actual size.

All products may not be available in all markets.

## Sternum Saw Blades

Cat. No.	Width (mm)	Length (mm)	Non-sterile
5059-531	10.00	54.00	
5059-031	10.00	54.00	
5059-031-01	10.00	54.00	50 Pack
5059-532	10.00	35.00	
5059-032-01	10.00	35.00	50 Pack
5059-233*		34.00	
5059-235**		32.00	

\* For use with Sarns Sternum Saw

\*\* For use with Stryer Sternum Saw

5059-531



5059-032-01



5059-233

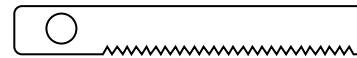

5059-235

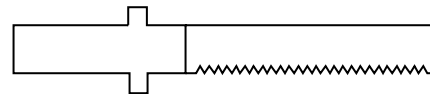

## Repeat Sternotomy Blades

Cat. No.	Width (mm)	Length (mm)	View Illustration
1384-175	52.00	19.00	Page 71
1384-176	63.00	19.00	Page 71
5023-187	50.00	24.00	Page 71
5023-188	63.00	24.00	Page 71
5023-178	44.60	40.00	Page 71
5023-179	54.60	40.00	Page 71
5023-180	65.80	40.00	Page 72
5059-278	44.60	40.00	Page 72
5059-279	54.60	40.00	Page 72
5059-280	65.80	40.00	Page 72
5071-125	50.00	19.00	Page 72
5071-126	63.00	19.00	Page 72
5071-228	44.50	40.00	Page 72
5071-229	54.50	40.00	Page 72
5071-230	66.00	40.00	Page 72

1384-175

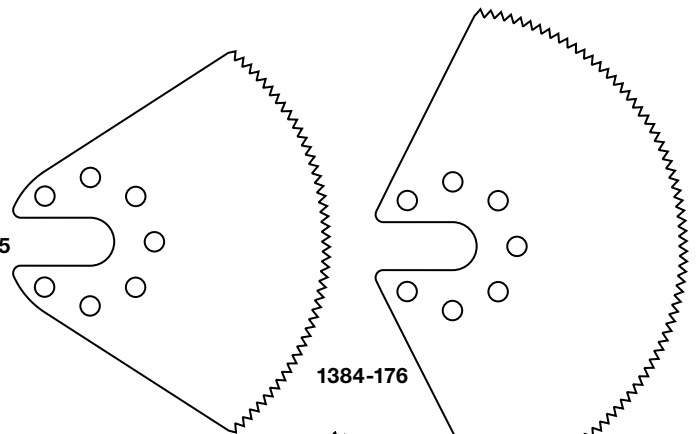

1384-176

5023-187

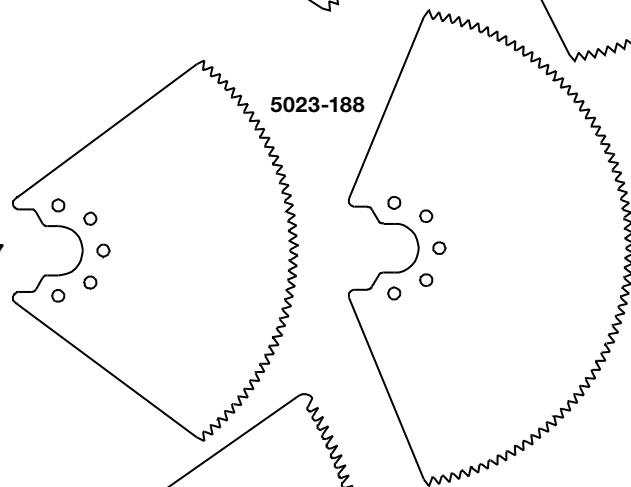

5023-188

5023-179

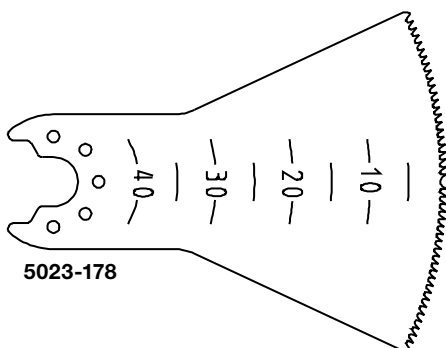

5023-178

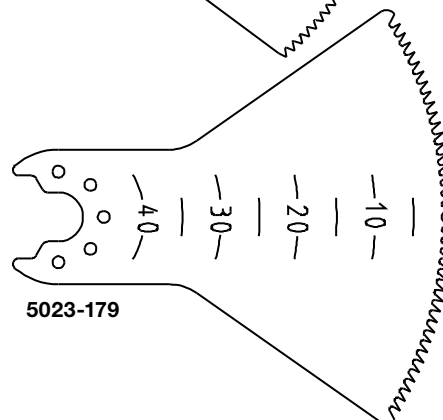

Products shown at actual size.  
All products may not be available in all markets.



# Sternum Saw Blades

Indications for Use: Primary & Repeat Sternotomy

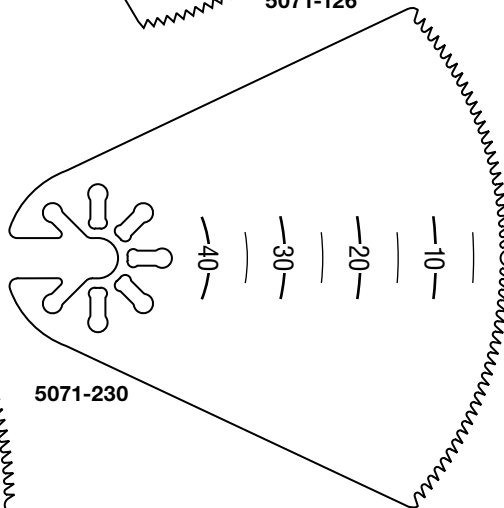
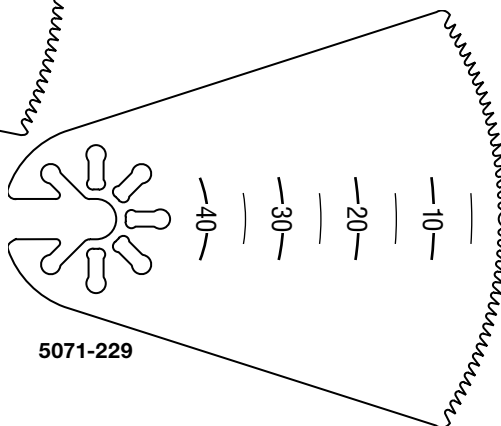
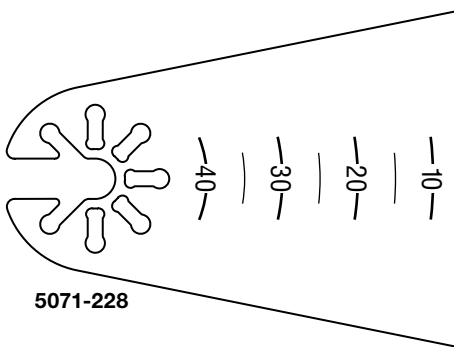
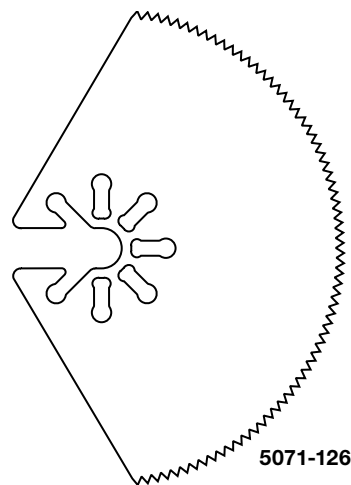
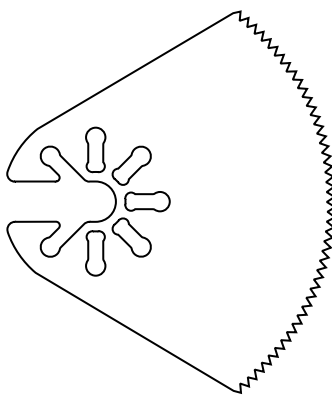
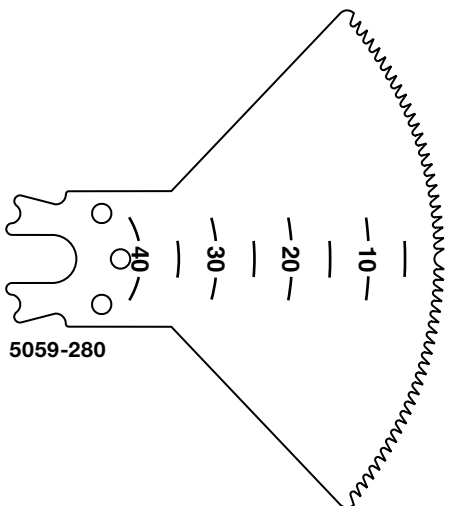
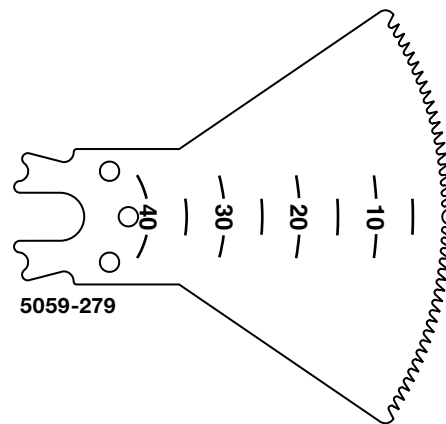
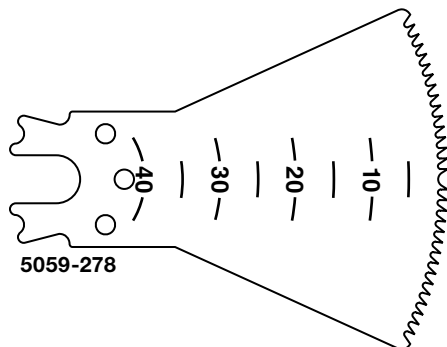
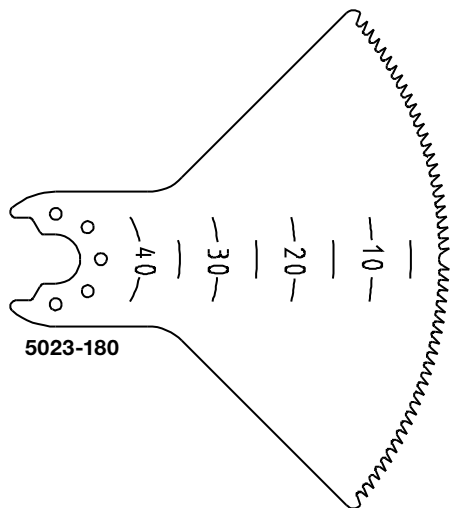

Products shown at actual size.  
All products may not be available in all markets.

HALL®  
**POWERED  
INSTRUMENTS  
INDEX**

<b>Cat. No.</b>	<b>Description</b>	<b>Page No.</b>
8703	MicroPower® & Micro 100™ ACL Sagittal Saw Blade	50
1365-005	Replacement Hex Wrench for Micro 100 Sagittal & Oscillating Saw	17
1365-016	Hall® Lubricant for Angled Attachments	10
1375-003	Bur Changer for 70 and 90 degree Angled Attachments	15
1375-011	Long Bur Guard	15
1375-012	Medium Bur Guard	15, 25
1375-015	Bur Brush	24, 25, 27, 28
1375-020	Laminectomy Guard	15
1375-021	Rhinoplasty Guard	15
1375-023	X-Long Bur Guard	15
1375-028	Micro 100 Footswitch	10
1375-032	20 degree Angled Attachment	15
1375-033	20 degree X-Long Angled Attachment	15
1375-034	70 degree Contra Angle with Dental Head	15
1375-035	70 degree Contra Angle with Surgical Head	15
1375-036	90 degree Angled Attachment	15
1375-037	Hall Lubricant for Surgical Angled Attachments	10
1375-040	Y Connector	10
1375-112	Burguard Sleeve Surgairtome Two	17
1384-175	Repeat Sternotomy Blade	71
1384-176	Repeat Sternotomy Blade	71
1387-022	Tissue Retractor	15
5020-053	2-Pedal Footswitch	9
5020-054	Console Stand	9
5020-160	Smartguard®	17
5023-055	MicroPower & Micro 100 Dermabrader Sagittal Saw Blade	51
5023-056	MicroPower & Micro 100 Dermabrader Sagittal Saw Blade	51
5023-057	MicroPower & Micro 100 Dermabrader Sagittal Saw Blade	51
5023-101	MicroPower Intra-Oral Oscillating Saw Blade	52
5023-102	MicroPower Intra-Oral Oscillating Saw Blade	52
5023-103	MicroPower Intra-Oral Oscillating Saw Blade	52
5023-104	MicroPower Intra-Oral Oscillating Saw Blade	52
5023-118	MicroPower & Micro 100 Sagittal Saw Blade	49
5023-128	MicroPower & Micro 100 Angled Sagittal Saw Blade	50
5023-129	MicroPower & Micro 100 Angled Sagittal Saw Blade	50
5023-130	MicroPower & Micro 100 Sagittal Saw Blade	49
5023-131	MicroPower & Micro 100 Sagittal Saw Blade	49
5023-132	MicroPower & Micro 100 Sagittal Saw Blade	49
5023-133	MicroPower & Micro 100 Sagittal Saw Blade	49
5023-134	MicroPower & Micro 100 Angled Sagittal Saw Blade	50
5023-135	MicroPower & Micro 100 Angled Sagittal Saw Blade	50
5023-136	MicroPower & Micro 100 Angled Sagittal Saw Blade	50
5023-137	MicroPower & Micro 100 Sagittal Saw Blade	49
5023-138	MicroPower & Micro 100 Sagittal Saw Blade	49
5023-139	MicroPower & Micro 100 Sagittal Saw Blade	49
5023-140	MicroPower & Micro 100 Sagittal Saw Blade	49
5023-141	MicroPower & Micro 100 Sagittal Saw Blade	49
5023-142	MicroPower & Micro 100 Sagittal Saw Blade	49
5023-143	MicroPower & Micro 100 Sagittal Saw Blade	49
5023-144	MicroPower & Micro 100 Sagittal Saw Blade	49
5023-160	MicroPower & Micro 100 Oscillating Saw Blade	52
5023-161	MicroPower & Micro 100 Oscillating Saw Blade	52
5023-162	MicroPower & Micro 100 Oscillating Saw Blade	52
5023-163	MicroPower & Micro 100 Oscillating Saw Blade	52

<b>Cat. No.</b>	<b>Description</b>	<b>Page No.</b>
5023-164	MicroPower™ & Micro 100™ Oscillating Saw Blade	52
5023-165	MicroPower & Micro 100 Oscillating Saw Blade	52
5023-166	MicroPower & Micro 100 Oscillating Saw Blade	52
5023-167	MicroPower & Micro 100 Angled Oscillating Saw Blade	52
5023-168	MicroPower & Micro 100 Angled Oscillating Saw Blade	52
5023-169	MicroPower & Micro 100 Oscillating Saw Blade	52
5023-170	MicroPower & Micro 100 Crescentic Oscillating Saw Blade	52
5023-171	MicroPower & Micro 100 Crescentic Oscillating Saw Blade	52
5023-172	MicroPower & Micro 100 Crescentic Oscillating Saw Blade	52
5023-176	MicroPower & Micro 100 Crescentic Oscillating Saw Blade	52
5023-178	Repeat Sternotomy Blade	71
5023-179	Repeat Sternotomy Blade	71
5023-180	Repeat Sternotomy Blade	71
5023-182	MicroPower & Micro 100 ACL Sagittal Saw Blade	50
5023-183	MicroPower & Micro 100 ACL Sagittal Saw Blade	50
5023-184	MicroPower & Micro 100 ACL Sagittal Saw Blade	50
5023-185	MicroPower & Micro 100 ACL Sagittal Saw Blade	50
5023-186	MicroPower & Micro 100 ACL Sagittal Saw Blade	50
5023-187	Repeat Sternotomy Blade	71
5023-188	Repeat Sternotomy Blade	71
5023-244	MicroPower & Micro 100 Sagittal Saw Blade	49
5023-247	MicroPower & Micro 100 Sagittal Saw Blade	49
5023-249	MicroPower & Micro 100 Sagittal Saw Blade	49
5023-258	MicroPower & Micro 100 Angled Oscillating Saw Blade	52
5023-259	MicroPower & Micro 100 Angled Oscillating Saw Blade	52
5023-405	MicroPower & Micro 100 Graft Harvesting Sagittal Saw Blade	51
5023-406	MicroPower & Micro 100 Graft Harvesting Sagittal Saw Blade	51
5023-407	MicroPower & Micro 100 Graft Harvesting Sagittal Saw Blade	51
5023-408	MicroPower & Micro 100 Graft Harvesting Sagittal Saw Blade	51
5023-409	MicroPower & Micro 100 Graft Harvesting Sagittal Saw Blade	51
5023-410	MicroPower & Micro 100 Graft Harvesting Sagittal Saw Blade	51
5023-411	MicroPower & Micro 100 Graft Harvesting Sagittal Saw Blade	51
5023-412	MicroPower & Micro 100 Graft Harvesting Sagittal Saw Blade	51
5023-413	MicroPower & Micro 100 Graft Harvesting Sagittal Saw Blade	51
5030-028	Holding Clamp Small	24
5030-029	Holding Clamp Medium	24
5038-001	Osteon™ Handpiece, Straight	20, 27, 28
5038-002	Osteon Handpiece, Angled	20, 27, 28
5038-004	Osteon Footswitch with Hose	20, 27, 28
5038-005	Osteon Hose	20, 27, 28
5038-009	Osteon and Ototom Bur Bur Rack,	20, 27, 28
5038-600	Osteon Tubing Set with irrigation tip	20
5039-003	AC Power Cord	9
5040-180	Fluid Bag Support Rod for D3000 & E9000	9
5044-145	MicroPower & Micro 100 Sagittal Saw Blade	49
5044-999-52	1/4" (6.35mm) Replacement Chuck Key	14
5044-999-53	5/32" (4.0mm) Replacement Chuck Key	14
5050-041	C-Wire	57
5050-042	C-Wire	57
5050-043	C-Wire	57
5050-044	C-Wire	57
5050-046	C-Wire	57
5050-047	C-Wire	57
5050-048	C-Wire	57

<b>Cat. No.</b>	<b>Description</b>	<b>Page No.</b>
5050-049	C-Wire	57
5052-010	Universal Hose, 10' (3.05m) for Hal <sup>®</sup> Handpieces	10, 22, 25, 26, 28
5052-012	Sterilization Case	20, 24, 25
5052-018	Extension Hose, 10' (3.05m), Male Schrader to Female Schrader	10
5052-029	Extension Hose, 10' (3.05m), Male Diss and Female Schrader	10
5052-041	Cebotome <sup>®</sup> Revision Drill Handpiece	22, 28
5052-042	Cebotome Bur Extension, Short	22, 28
5052-046	Cebotome Bur Wrench	22, 28
5052-048	Standard Bur Extension, Medium, use with standard Cebotome Burs	22, 28
5052-049	Standard Bur Extension, Long, use with standard Cebotome Burs	22
5052-125	Cebotome Metal Cutting Wheel	28, 70
5052-126	Cebotome Metal Trimming Wheel	28, 70
5052-129	Cebotome Metal Cutting Wheel Wrench	28
5052-135	Stryker Large Bone Reciprocating Blade	48
5052-142	Cebotome Metal Cutting Bur Extension	22, 28
5052-143	Cebotome Metal Cutting Bur Wrench	22, 28
5052-144	ST Cebotome Metal Cutting Bur, Side, Flat	28, 70
5052-145	ST Cebotome Metal Cutting Bur, Side, Round	28, 70
5052-173	Hall Large Bone Reciprocating Blade	47
5052-179	Hall Large Bone Reciprocating Blade	47
5052-181	Cebotome Bur	70
5052-182	Cebotome Bur	70
5052-183	Cebotome Bur	70
5052-184	Cebotome Bur	70
5052-185	Cebotome Bur	70
5052-186	Cebotome Bur	70
5052-187	Cebotome Bur	70
5052-188	Cebotome Bur	70
5052-189	Cebotome Bur	70
5052-190	Cebotome Bur	70
5052-191	Cebotome Bur	70
5052-192	Cebotome Bur	70
5052-258	Hall Large Bone Reciprocating Blade	47
5052-259	Hall Large Bone Reciprocating Blade	47
5052-260	Hall Large Bone Reciprocating Blade	47
5052-261	Hall Large Bone Reciprocating Blade	47
5052-276	Hall Large Bone Reciprocating Blade	47
5052-281	Hall Large Bone Reciprocating Blade	47
5052-291	Hall Large Bone Reciprocating Blade	47
5052-332	Stryker Large Bone Reciprocating Blade	48
5052-333	Stryker Large Bone Reciprocating Blade	48
5052-334	Stryker Large Bone Reciprocating Blade	48
5053-009	Micro 100 <sup>™</sup> Medium Speed Drill	17
5053-010	Micro 100 Reciprocating Saw	17
5053-011	Micro 100 Sagittal Saw	17
5053-012	Micro 100 Oscillating Saw	17
5053-013	Wire Driver	17
5053-019	Wire Driver Adapter Chuck for use with 5053-013	17
5053-022	Micro 100 XL Oscillating Saw	17
5053-050	MicroPower <sup>®</sup> & Micro 100 Depth Limiting Reciprocating Saw Blade	53
5053-051	MicroPower & Micro 100 Depth Limiting Reciprocating Saw Blade	53
5053-052	MicroPower & Micro 100 Depth Limiting Reciprocating Saw Blade	53
5053-053	MicroPower & Micro 100 Depth Limiting Reciprocating Saw Blade	53
5053-054	MicroPower & Micro 100 Reciprocating Saw Blade	53

<b>Cat. No.</b>	<b>Description</b>	<b>Page No.</b>
5053-074	Throttle Clip (for lever) Used during footswitch operation	17
5053-080	MicroPower™ & Micro 100™ Reciprocating Rasp	53
5053-081	MicroPower & Micro 100 Reciprocating Rasp	53
5053-082	MicroPower & Micro 100 Reciprocating Rasp	53
5053-083	MicroPower & Micro 100 Reciprocating Rasp	53
5053-084	MicroPower & Micro 100 Reciprocating Rasp	53
5053-085	MicroPower & Micro 100 Reciprocating Rasp	53
5053-122	MicroPower & Micro 100 Reciprocating Saw Blade	53
5053-123	Wire Guard for use with 5053-013	17
5053-124	Cleaning Brush for Cannulated Handpieces	24
5053-126	MicroPower & Micro 100 Reciprocating Saw Blade	53
5053-220	MicroPower & Micro 100 Reciprocating Saw Blade	53
5053-221	MicroPower & Micro 100 Reciprocating Saw Blade	53
5056-080	Osteon™ 80 Grit Dermabrasion Bur	69
5056-081	Osteon 80 Grit Dermabrasion Bur	69
5056-082	Osteon 80 Grit Dermabrasion Bur	69
5056-083	Osteon 80 Grit Dermabrasion Bur	69
5056-109	Osteon/Ototome Bur Set, includes 16 burs (see System Listings Page 26)	20
5056-116	Osteon Fluted Round Bur	69
5056-117	Osteon Fluted Round Bur	27, 69
5056-118	Osteon Fluted Round Bur	27, 69
5056-119	Osteon Fluted Round Bur	69
5056-125	Osteon Fluted Round Bur	69
5056-126	Osteon Fluted Round Bur	27, 69
5056-127	Osteon Fluted Round Bur	69
5056-128	Osteon Fluted Round Bur	69
5056-140	Osteon Fluted Round Bur	27, 69
5056-142	Osteon Fluted Round Bur	27, 69
5056-144	Osteon Fluted Round Bur	69
5056-145	Osteon Fluted Round Bur	27, 69
5056-146	Osteon Fluted Round Bur	27, 69
5056-147	Osteon Fine Diamond Round Bur	69
5056-148	Osteon Fine Diamond Round Bur	69
5056-149	Osteon Fluted Round Bur	69
5056-150	Osteon Fine Diamond Round Bur	69
5056-152	Osteon Fine Diamond Round Bur	27, 69
5056-158	Osteon Fine Diamond Round Bur	27, 69
5056-159	Osteon Fine Diamond Round Bur	27, 69
5056-160	Osteon Fine Diamond Round Bur	69
5056-161	Osteon Fine Diamond Round Bur	27, 69
5056-162	Osteon Fine Diamond Round Bur	27, 69
5056-163	Osteon Fine Diamond Round Bur	69
5056-164	Osteon Fluted Round Bur	27, 69
5056-165	Osteon Fluted Round Bur	69
5056-166	Osteon Fluted Round Bur	27, 69
5056-167	Osteon Fine Diamond Round Bur	69
5056-168	Osteon Fine Diamond Round Bur	69
5056-170	Osteon Deep Access Bur	69
5056-171	Osteon Deep Access Bur	69
5056-172	Osteon Deep Access Bur	69
5056-173	Osteon Fluted Round Bur	69
5056-174	Osteon Fluted Round Bur	69
5056-175	Osteon Deep Access Bur	69
5056-176	Osteon Deep Access Bur	69

Cat. No.	Description	Page No.
5056-177	Osteon™ Fluted Round Bur	69
5056-178	Osteon Fluted Round Bur	69
5056-179	Osteon Fluted Round Bur	69
5056-184	Osteon Wire Pass Bur	69
5056-185	Osteon Wire Pass Bur	69
5056-186	Osteon Wire Pass Bur	69
5056-950	Osteon Coarse Diamond Round Bur	69
5056-952	Osteon Coarse Diamond Round Bur	69
5056-958	Osteon Coarse Diamond Round Bur	69
5056-959	Osteon Coarse Diamond Round Bur	69
5056-962	Osteon Coarse Diamond Round Bur	69
5056-967	Osteon Coarse Diamond Round Bur	69
5057-040	Repeat Sternotomy Saw, Pneumatic	21
5058-000	Surgairtome Two® High Speed Drill Kit (System listing on page 24)	17
5058-001	Surgairtome Two High Speed Drill	17, 25
5059-005	Pneumatic Sternum Saw	21
5059-006	Sternum Guard, 2.25" (5.72mm), for PRO6450, PRO6450M & 5059-005	21
5059-007	Sternum Saw Wrench, for PRO6450, PRO6450M & 5059-005	21
5059-011	Sternum Guard, 3.12" (7.92mm), for PRO6450, PRO6450M & 5059-005	21
5059-031	Sternum Saw Blade	71
5059-031-01	Sternum Saw Blade	71
5059-032-01	Sternum Saw Blade	71
5059-233	Sternum Saw Blade	71
5059-235	Sternum Saw Blade	71
5059-278	Repeat Sternotomy Blade	71, 72
5059-279	Repeat Sternotomy Blade	71, 72
5059-280	Repeat Sternotomy Blade	71, 72
5059-531	Sternum Saw Blade	71
5059-532	Sternum Saw Blade	71
5071-105	Graft Harvesting Large Bone Oscillating Blade	42
5071-106	Graft Harvesting Large Bone Oscillating Blade	42
5071-107	Graft Harvesting Large Bone Oscillating Blade	42
5071-108	Graft Harvesting Large Bone Oscillating Blade	42
5071-109	Graft Harvesting Large Bone Oscillating Blade	42
5071-110	Graft Harvesting Large Bone Oscillating Blade	42
5071-111	Graft Harvesting Large Bone Oscillating Blade	42
5071-112	Graft Harvesting Large Bone Oscillating Blade	42
5071-113	Graft Harvesting Large Bone Oscillating Blade	42
5071-120	Hall™ Large Bone Knee Blade	32, 34
5071-121	Hall Large Bone Knee Blade	32, 34
5071-123	Hall Large Bone Knee Blade	32, 37
5071-124	Hall Large Bone Knee Blade	32, 38
5071-125	Repeat Sternotomy Blade	71, 72
5071-126	Repeat Sternotomy Blade	71, 72
5071-127	ACL Large Bone Oscillating Blade	42
5071-129	Hall Large Bone Knee Blade	32, 38
5071-132	Large Bone Oscillating Blade	43
5071-133	ACL Large Bone Oscillating Blade	42
5071-134	ACL Large Bone Oscillating Blade	42
5071-135	ACL Large Bone Oscillating Blade	42
5071-140	Large Bone Oscillating Blade	43, 46
5071-141	Large Bone Oscillating Blade	43, 46
5071-142	Large Bone Oscillating Blade	43, 46
5071-143	Large Bone Oscillating Blade	43, 45

<b>Cat. No.</b>	<b>Description</b>	<b>Page No.</b>
5071-144	Hall® Large Bone Knee Blade	32, 38
5071-145	Large Bone Oscillating Blade	43, 46
5071-146	Hall Large Bone Knee Blade	32, 34
5071-161	Hall Large Bone Knee Blade	32, 37
5071-163	Hall Large Bone Knee Blade	32, 38
5071-166	Large Bone Oscillating Blade	43, 44
5071-167	Hall Large Bone Knee Blade	32, 35
5071-174	Large Bone Oscillating Blade	43, 45
5071-175	Large Bone Oscillating Abrader	46
5071-177	Large Bone Oscillating Blade	43, 44
5071-178	Large Bone Oscillating Blade	43, 45
5071-180	Hall Large Bone Knee Blade	32, 36
5071-181	Hall Large Bone Knee Blade	32, 36
5071-184	Hall Large Bone Knee Blade	32, 35
5071-185	Hall Large Bone Knee Blade	32, 33
5071-186	Large Bone Oscillating Blade	43, 44
5071-187	Large Bone Oscillating Blade	43, 45
5071-188	Large Bone Oscillating Blade	43, 45
5071-195	Hall Large Bone Knee Blade	32, 34
5071-196	Hall Large Bone Knee Blade	32, 34
5071-201	Hall Large Bone Knee Blade	32, 36
5071-228	Repeat Sternotomy Blade	71, 72
5071-229	Repeat Sternotomy Blade	71, 72
5071-230	Repeat Sternotomy Blade	71, 72
5071-236	ACL Large Bone Oscillating Blade	42
5071-246	ACL Large Bone Oscillating Blade	42
5071-300	Intrex® Blade	31
5071-301	Intrex Blade	31
5071-302	Intrex Blade	31
5071-303	Intrex Blade	31
5071-304	Intrex Blade	31
5071-305	Intrex Blade	31
5071-306	Intrex Blade	31
5071-310	Intrex Blade	31
5071-311	Intrex Blade	31
5071-312	Intrex Blade	31
5071-313	Intrex Blade	31
5071-314	Intrex Blade	31
5071-315	Intrex Blade	31
5071-316	Intrex Blade	31
5071-320	Intrex Blade	31
5071-321	Intrex Blade	31
5071-322	Intrex Blade	31
5071-323	Intrex Blade	31
5071-324	Intrex Blade	31
5071-325	Intrex Blade	31
5071-326	Intrex Blade	31
5071-330	Intrex Blade	31
5071-331	Intrex Blade	31
5071-332	Intrex Blade	31
5071-333	Intrex Blade	31
5071-334	Intrex Blade	31
5071-335	Intrex Blade	31
5071-336	Intrex Blade	31



# Numerical Index



<b>Cat. No.</b>	<b>Description</b>	<b>Page No.</b>
5071-340	Intrex® Blade	31
5071-341	Intrex Blade	31
5071-342	Intrex Blade	31
5071-343	Intrex Blade	31
5071-344	Intrex Blade	31
5071-345	Intrex Blade	31
5071-346	Intrex Blade	31
5071-350	Intrex Blade	31
5071-351	Intrex Blade	31
5071-352	Intrex Blade	31
5071-353	Intrex Blade	31
5071-354	Intrex Blade	31
5071-355	Intrex Blade	31
5071-356	Intrex Blade	31
5071-519	Hall® Large Bone Knee Blade	32, 37
5071-525	Hall Large Bone Knee Blade	32, 38
5071-526	Hall Large Bone Knee Blade	32, 35
5071-527	Hall Large Bone Knee Blade	32, 36
5071-528	Hall Large Bone Knee Blade	32, 33
5071-529	Hall Large Bone Knee Blade	32, 38
5071-530	Hall Large Bone Knee Blade	32, 38
5071-531	Hall Large Bone Knee Blade	32, 36
5071-532	Hall Large Bone Knee Blade	32, 33
5071-533	Hall Large Bone Knee Blade	32, 33
5071-534	Hall Large Bone Knee Blade	32, 35
5071-538	Hall Large Bone Knee Blade	32, 34
5071-539	Hall Large Bone Knee Blade	32, 38
5071-547	Hall Large Bone Knee Blade	32, 35
5071-548	Hall Large Bone Knee Blade	32, 34
5071-550	Large Bone Oscillating Blade	43, 44
5071-551	Large Bone Oscillating Blade	43
5071-552	Large Bone Oscillating Blade	43, 44
5071-553	Large Bone Oscillating Blade	43
5071-554	Large Bone Oscillating Blade	43, 46
5071-555	Large Bone Oscillating Blade	43, 46
5071-556	Large Bone Oscillating Blade	43, 44
5071-557	Large Bone Oscillating Blade	43, 45
5071-558	Hall Large Bone Knee Blade	32, 35
5071-560	Large Bone Oscillating Blade	43, 45
5071-562	Hall Large Bone Knee Blade	32, 34
5071-564	Hall Large Bone Knee Blade	32, 37
5071-565	Hall Large Bone Knee Blade	32, 38
5071-568	Hall Large Bone Knee Blade	32, 37
5071-570-50	Hall Large Bone Knee Blade	32, 35
5071-571	ACL Large Bone Oscillating Blade	42
5071-572	Large Bone Oscillating Blade	43, 45
5071-573	Hall Large Bone Knee Blade	32, 35
5071-576	Hall Large Bone Knee Blade	32, 37
5071-582	Hall Large Bone Knee Blade	32, 36
5071-583	Hall Large Bone Knee Blade	32, 33
5071-589	Hall Large Bone Knee Blade	32, 33
5071-590	Hall Large Bone Knee Blade	32, 37
5071-594	Hall Large Bone Knee Blade	32, 33
5072-100	Stryker Large Bone Knee Blade	39

<b>Cat. No.</b>	<b>Description</b>	<b>Page No.</b>
5072-101	Stryker Large Bone Knee Blade	41
5072-102	Stryker Large Bone Knee Blade	40
5072-105	Stryker Large Bone Knee Blade	39, 40
5072-109	Stryker Large Bone Knee Blade	39, 40
5072-110	Stryker Large Bone Knee Blade	39, 41
5072-111	Stryker Large Bone Knee Blade	39, 41
5072-140	Stryker Large Bone Knee Blade	39
5072-142	Stryker Large Bone Knee Blade	39, 40
5072-143	Stryker Large Bone Knee Blade	39
5072-145	Stryker Large Bone Knee Blade	39
5072-150	Stryker Large Bone Knee Blade	39
5072-151	Stryker Large Bone Knee Blade	39, 40
5072-152	Stryker Large Bone Knee Blade	39, 40
5072-158	Stryker Large Bone Knee Blade	39, 41
5072-176	Stryker Large Bone Knee Blade	39, 41
5072-177	Stryker Large Bone Knee Blade	39, 41
5072-181	Stryker Large Bone Knee Blade	39, 41
5072-183	Stryker Large Bone Knee Blade	39, 41
5072-185	Stryker Large Bone Knee Blade	39, 41
5072-195	Stryker Large Bone Knee Blade	39, 40
5072-218	Stryker Large Bone Knee Blade	39, 40
5089-208	MicroPower® & Micro 100™ Straight Side – Cutting Small Bone Bur	55
5090-247	MicroPower & Micro 100 Wire Pass Small Bone Bur	54
5090-248	MicroPower & Micro 100 Wire Pass Small Bone Bur	54
5090-249	MicroPower & Micro 100 Wire Pass Small Bone Bur	54
5091-080	MicroPower & Micro 100 Dermabraders – Fine Diamond Small Bone Bur	54
5091-081	MicroPower & Micro 100 Dermabraders – Fine Diamond Small Bone Bur	54
5091-082	MicroPower & Micro 100 Dermabraders – Fine Diamond Small Bone Bur	54
5091-083	MicroPower & Micro 100 Dermabraders – Fine Diamond Small Bone Bur	54
5091-201	MicroPower & Micro 100 Straight Side – Cutting Small Bone Bur	55
5091-202	MicroPower & Micro 100 Straight Side – Cutting Small Bone Bur	55
5091-204	MicroPower & Micro 100 Straight Side – Cutting Small Bone Bur	55
5091-206	MicroPower & Micro 100 Tapered Side-cutting Small Bone Bur	55
5091-212	MicroPower & Micro 100 Lindemann Small Bone Bur	56
5091-213	MicroPower & Micro 100 Tapered Cross-Cut Fissure Small Bone Bur	56
5091-214	MicroPower & Micro 100 Tapered Side-Cutting Small Bone Bur	55
5091-215	MicroPower & Micro 100 Tapered Side-Cutting Small Bone Bur	55
5091-216	MicroPower & Micro 100 Straight Side – Cutting Small Bone Bur	55
5091-217	MicroPower & Micro 100 Straight Side – Cutting Small Bone Bur	55
5091-218	MicroPower & Micro 100 Tapered Side-cutting Small Bone Bur	55
5091-219	MicroPower & Micro 100 Tapered Side-cutting Small Bone Bur	55
5091-221	MicroPower & Micro 100 Round Fluted Small Bone Bur	54
5091-222	MicroPower & Micro 100 Round Fluted Small Bone Bur	54
5091-223	MicroPower & Micro 100 Round Fluted Small Bone Bur	54
5091-224	MicroPower & Micro 100 Round Fluted Small Bone Bur	54
5091-225	MicroPower & Micro 100 Round Fluted Small Bone Bur	54
5091-226	MicroPower & Micro 100 Round Fluted Small Bone Bur	54
5091-228	MicroPower & Micro 100 Round Fluted Small Bone Bur	54
5091-230	MicroPower & Micro 100 Round Fluted Small Bone Bur	54
5091-232	MicroPower & Micro 100 Round Fluted Small Bone Bur	54
5091-236	MicroPower & Micro 100 Oval Small Bone Bur	55
5091-238	MicroPower & Micro 100 Oval Small Bone Bur	55
5091-242	MicroPower & Micro 100 Swanson Reamer Small Bone Bur	54
5091-243	MicroPower & Micro 100 Swanson Reamer Small Bone Bur	54

<b>Cat. No.</b>	<b>Description</b>	<b>Page No.</b>
5091-244	MicroPower™ & Micro 100™ Swanson Reamer Small Bone Bur	54
5091-245	MicroPower & Micro 100 Swanson Reamer Small Bone Bur	54
5091-247	MicroPower & Micro 100 Wire Pass Small Bone Bur	54
5091-248	MicroPower & Micro 100 Wire Pass Small Bone Bur	54
5091-249	MicroPower & Micro 100 Wire Pass Small Bone Bur	54
5091-252	MicroPower & Micro 100 Barrel Small Bone Bur	55
5091-254	MicroPower & Micro 100 Barrel Small Bone Bur	55
5091-260	MicroPower & Micro 100 Fine Round Diamond Small Bone Bur	54
5091-264	MicroPower & Micro 100 Fine Round Diamond Small Bone Bur	54
5091-268	MicroPower & Micro 100 Fine Round Diamond Small Bone Bur	54
5091-270	MicroPower & Micro 100 Dermabraders – Fine Diamond Small Bone Bur	54
5091-271	MicroPower & Micro 100 Tapered Cross-cut Fissure Small Bone Bur	56
5091-272	MicroPower & Micro 100 Tapered Cross-cut Fissure Small Bone Bur	56
5092-203	MicroPower & Micro 100 Straight Side – Cutting Small Bone Bur	55
5092-204	MicroPower & Micro 100 Straight Side – Cutting Small Bone Bur	55
5092-206	MicroPower & Micro 100 Tapered Side-cutting Small Bone Bur	55
5092-214	MicroPower & Micro 100 Tapered Side-cutting Small Bone Bur	55
5092-220	MicroPower & Micro 100 Round Fluted Small Bone Bur	54
5092-222	MicroPower & Micro 100 Round Fluted Small Bone Bur	54
5092-224	MicroPower & Micro 100 Round Fluted Small Bone Bur	54
5092-226	MicroPower & Micro 100 Round Fluted Small Bone Bur	54
5092-228	MicroPower & Micro 100 Round Fluted Small Bone Bur	54
5092-230	MicroPower & Micro 100 Round Fluted Small Bone Bur	54
5092-232	MicroPower & Micro 100 Round Fluted Small Bone Bur	54
5092-236	MicroPower & Micro 100 Round Fluted Small Bone Bur	54, 55
5092-238	MicroPower & Micro 100 Oval Small Bone Bur	55
5092-247	MicroPower & Micro 100 Wire Pass Small Bone Bur	54
5092-252	MicroPower & Micro 100 Barrel Small Bone Bur	55
5092-254	MicroPower & Micro 100 Barrel Small Bone Bur	55
5092-260	MicroPower & Micro 100 Fine Round Diamond Small Bone Bur	54
5092-262	MicroPower & Micro 100 Fine Round Diamond Small Bone Bur	54
5092-264	MicroPower & Micro 100 Fine Round Diamond Small Bone Bur	54
5092-266	MicroPower & Micro 100 Fine Round Diamond Small Bone Bur	54
5092-268	MicroPower & Micro 100 Fine Round Diamond Small Bone Bur	54
5092-270	MicroPower & Micro 100 Dermabraders – Fine Diamond Small Bone Bur	54
5092-271	MicroPower & Micro 100 Tapered Cross-cut Fissure Small Bone Bur	56
5092-272	MicroPower & Micro 100 Tapered Cross-cut Fissure Small Bone Bur	56
5092-273	MicroPower & Micro 100 Tapered Cross-cut Fissure Small Bone Bur	56
5092-283	MicroPower & Micro 100 Heavy Grit Diamond-Microbur. X-Long Small Bone Bur	56
5092-284	MicroPower & Micro 100 Heavy Grit Diamond-Microbur. X-Long Small Bone Bur	56
5092-285	MicroPower & Micro 100 Heavy Grit Diamond-Microbur. X-Long Small Bone Bur	56
5092-286	MicroPower & Micro 100 Heavy Grit Diamond-Microbur. X-Long Small Bone Bur	56
5092-291	MicroPower & Micro 100 Cylindrical Small Bone Bur	56
5093-220	MicroPower & Micro 100 Round Fluted Small Bone Bur	54
5093-221	MicroPower & Micro 100 Round Fluted Small Bone Bur	54
5093-224	MicroPower & Micro 100 Round Fluted Small Bone Bur	54
5093-226	MicroPower & Micro 100 Round Fluted Small Bone Bur	54
5093-228	MicroPower & Micro 100 Round Fluted Small Bone Bur	54
5093-230	MicroPower & Micro 100 Round Fluted Small Bone Bur	54
5093-232	MicroPower & Micro 100 Round Fluted Small Bone Bur	54
5093-236	MicroPower & Micro 100 Oval Small Bone Bur	55
5093-238	MicroPower & Micro 100 Oval Small Bone Bur	55
5093-260	MicroPower & Micro 100 Fine Round Diamond Small Bone Bur	54
5093-262	MicroPower & Micro 100 Fine Round Diamond Small Bone Bur	54

<b>Cat. No.</b>	<b>Description</b>	<b>Page No.</b>
5093-264	MicroPower® & Micro 100™ Fine Round Diamond Small Bone Bur	54
5093-266	MicroPower & Micro 100 Fine Round Diamond Small Bone Bur	54
5093-282	MicroPower & Micro 100 Heavy Grit Diamond-Microbur. X-Long Small Bone Bur	56
5093-283	MicroPower & Micro 100 Heavy Grit Diamond-Microbur. X-Long Small Bone Bur	56
5093-284	MicroPower & Micro 100 Heavy Grit Diamond-Microbur. X-Long Small Bone Bur	56
5093-285	MicroPower & Micro 100 Heavy Grit Diamond-Microbur. X-Long Small Bone Bur	56
5144-002	Schrader Coupler	10
5271-502	Hall® Large Bone Knee Blade	32, 33
5271-561	Hall Large Bone Knee Blade	32, 37
5271-580	Hall Large Bone Knee Blade	32, 36
6020-021	MicroPower Medium Speed Drill Removable Lever	16
6020-022	MicroPower Sagittal Saw Removable Lever	16
6020-023	MicroPower Reciprocating Saw Removable Lever	16
6020-024	MicroPower Oscillating Saw Removable Lever	16
6020-025	Oral Max™ High Speed Drill Removable Lever	16
6020-026	MicroPower Orthopedic High Speed Drill Removable Lever	16
6020-260	Smartguard Irrigator	17
6021-021	MicroPower Medium Speed Drill Permanently Attached Lever	16
6021-022	MicroPower Sagittal Saw Permanently Attached Lever	16
6021-023	MicroPower Reciprocating Saw Permanently Attached Lever	16
6021-024	MicroPower Oscillating Saw Permanently Attached Lever	16
6021-025	Oral Max High Speed Drill Permanently Attached Lever	16
6021-026	MicroPower Orthopedic High Speed Drill Permanently Attached Lever	16
7007-03	Staplizer® Cartridge	57
7010-03	Staplizer Cartridge	57
7015-03	Staplizer Cartridge	57
7020-001	Ultrapower® High Speed Drill	19, 25, 26
7020-002	Ultrapower Low Speed Drill	19, 25, 26
7020-003	Ultrapower Perforator Drive	19, 25, 26
7020-010	Short Bur Guard (like Midas-X) Red	19, 25, 26
7020-011	Medium Bur Guard (like Midas-O) Copper	19, 25, 26
7020-012	Long Bur Guard (like Midas-M/B) Mustard	19, 25, 26
7020-013	X-Long Bur Guard (like Midas-AM/A) Lime	19, 25, 26
7020-014	Short Revision Extension (like Midas TU) Teal	19, 25, 26
7020-015	Medium Revision Extension (like Midas-R) Purple	19, 25, 26
7020-016	Long Revision Extension (like Midas RX) Blue	19, 25, 26
7020-017	Short Bur Guard (like Midas B-5) Black	19, 25, 26
7020-018	Medium Bur Guard (like Midas B-1) Green	19, 25, 26
7020-019	Long Bur Guard (like Midas S-1) Brown	19, 25, 26
7020-022	90 degree Angle Attachment (like Midas AF/BF)	19, 25, 26
7020-023	20 degree Long Keyless Attachment	19, 25, 26
7020-024	20 degree Angle X-Long Keyless Attachment	19, 25, 26
7020-040	Key Wrench, 2 per box	25, 26
7020-041	Attachment Spray	25, 26
7020-045	Ultrapower Footswitch	19, 25, 26
7020-046	Bur Cabinet for Neuro Burs	18, 25, 26
7021-012	UltraPower Side Cutting Bur	66
7021-013	UltraPower Side Cutting Bur	66
7021-015	UltraPower Side Cutting Bur	66
7021-024	UltraPower Round Fluted Bur	64
7021-025	UltraPower Round Fluted Bur	64
7021-026	UltraPower Round Fluted Bur	64
7021-027	UltraPower Round Fluted Bur	64
7021-028	UltraPower Round Fluted Bur	64

<b>Cat. No.</b>	<b>Description</b>	<b>Page No.</b>
7021-029	UltraPower® Round Fluted Bur	64
7021-030	UltraPower Round Fluted Bur	64
7021-031	UltraPower Round Fluted Bur	64
7021-032	UltraPower Round Fluted Bur	64
7021-033	UltraPower Round Fluted Bur	64
7021-034	UltraPower Round Fluted Bur	64
7021-036	UltraPower Fluted Cylindrical Bur	66
7021-037	UltraPower Fluted Cylindrical Bur	66
7021-040	UltraPower Wire Pass Bur	68
7021-041	UltraPower Wire Pass Bur	68
7021-042	UltraPower Wire Pass Bur	68
7021-043	UltraPower Side Cutting Bur	66
7021-051	UltraPower Trepine Bur	67
7021-062	UltraPower Fine Round Diamond Bur	64
7021-063	UltraPower Fine Round Diamond Bur	64
7021-064	UltraPower Fine Round Diamond Bur	64
7021-065	UltraPower Fine Round Diamond Bur	64
7021-066	UltraPower Fine Round Diamond Bur	64
7021-074	UltraPower Coarse Round Diamond Bur	65
7021-075	UltraPower Coarse Round Diamond Bur	65
7021-077	UltraPower Coarse Round Diamond Bur	65
7021-081	UltraPower Fluted Acorn Bur	67
7021-083	UltraPower Fluted Acorn Bur	67
7021-092	UltraPower Fine Diamond Wheels for Metal Cutting Bur	68
7021-094	UltraPower Carbide Metal Cutting Bur	68
7021-095	UltraPower Oval Fluted Bur	68
7021-096	UltraPower Oval Fluted Bur	68
7021-112	UltraPower Side Cutting Bur	66
7021-113	UltraPower Side Cutting Bur	66
7021-114	UltraPower Side Cutting Bur	66
7021-115	UltraPower Side Cutting Bur	66
7021-116	UltraPower Side Cutting Bur	66
7021-119	UltraPower Side Cutting Bur	66
7021-122	UltraPower Round Fluted Bur	64
7021-123	UltraPower Round Fluted Bur	64
7021-124	UltraPower Round Fluted Bur	64
7021-125	UltraPower Round Fluted Bur	64
7021-126	UltraPower Round Fluted Bur	64
7021-127	UltraPower Round Fluted Bur	64
7021-128	UltraPower Round Fluted Bur	64
7021-129	UltraPower Round Fluted Bur	64
7021-130	UltraPower Round Fluted Bur	64
7021-131	UltraPower Round Fluted Bur	64
7021-132	UltraPower Round Fluted Bur	64
7021-133	UltraPower Round Fluted Bur	64
7021-134	UltraPower Round Fluted Bur	64
7021-136	UltraPower Fluted Cylindrical Bur	66
7021-137	UltraPower Fluted Cylindrical Bur	66
7021-140	UltraPower Wire Pass Bur	68
7021-141	UltraPower Wire Pass Bur	68
7021-141-35	UltraPower Wire Pass Burs – Depth Limiting Bur	68
7021-141-50	UltraPower Wire Pass Burs – Depth Limiting Bur	68
7021-141-90	UltraPower Wire Pass Burs – Depth Limiting Bur	68
7021-142	UltraPower Wire Pass Bur	68

<b>Cat. No.</b>	<b>Description</b>	<b>Page No.</b>
7021-143	UltraPower® Side Cutting Bur	66
7021-145-70	UltraPower Wire Pass Burs – Depth Limiting Bur	68
7021-161	UltraPower Fine Round Diamond Bur	64
7021-162	UltraPower Fine Round Diamond Bur	64
7021-163	UltraPower Fine Round Diamond Bur	64
7021-164	UltraPower Fine Round Diamond Bur	64
7021-165	UltraPower Fine Round Diamond Bur	64
7021-166	UltraPower Fine Round Diamond Bur	64
7021-167	UltraPower Fine Round Diamond Bur	64
7021-171	UltraPower Coarse Round Diamond Bur	65
7021-172	UltraPower Coarse Round Diamond Bur	65
7021-173	UltraPower Coarse Round Diamond Bur	65
7021-174	UltraPower Coarse Round Diamond Bur	65
7021-175	UltraPower Coarse Round Diamond Bur	65
7021-176	UltraPower Coarse Round Diamond Bur	65
7021-177	UltraPower Coarse Round Diamond Bur	65
7021-181	UltraPower Fluted Acorn Bur	67
7021-182	UltraPower Fluted Acorn Bur	67
7021-183	UltraPower Fluted Acorn Bur	67
7021-195	UltraPower Oval Fluted Bur	68
7021-196	UltraPower Oval Fluted Bur	68
7021-202	UltraPower Side Cutting Bur	65
7021-206	UltraPower Side Cutting Bur	65
7021-207	UltraPower Side Cutting Bur	65
7021-210	UltraPower Side Cutting Bur	65
7021-214	UltraPower Side Cutting Bur	66
7021-218	UltraPower Side Cutting Bur	66
7021-220	UltraPower Round Fluted Bur	64
7021-222	UltraPower Round Fluted Bur	64
7021-223	UltraPower Round Fluted Bur	64
7021-224	UltraPower Round Fluted Bur	64
7021-225	UltraPower Round Fluted Bur	64
7021-226	UltraPower Round Fluted Bur	64
7021-227	UltraPower Round Fluted Bur	64
7021-228	UltraPower Round Fluted Bur	64
7021-229	UltraPower Round Fluted Bur	64
7021-230	UltraPower Round Fluted Bur	64
7021-231	UltraPower Round Fluted Bur	64
7021-232	UltraPower Round Fluted Bur	64
7021-233	UltraPower Round Fluted Bur	64
7021-235	UltraPower Fluted Cylindrical Bur	66
7021-236	UltraPower Fluted Cylindrical Bur	66
7021-237	UltraPower Fluted Cylindrical Bur	66
7021-243	UltraPower Side Cutting Bur	66
7021-250	UltraPower Trepine Bur	67
7021-252	UltraPower Trepine Bur	67
7021-253	UltraPower Trepine Bur	67
7021-255	UltraPower Trepine Bur	67
7021-261	UltraPower Fine Round Diamond Bur	64
7021-262	UltraPower Fine Round Diamond Bur	64
7021-263	UltraPower Fine Round Diamond Bur	64
7021-264	UltraPower Fine Round Diamond Bur	64
7021-265	UltraPower Fine Round Diamond Bur	64
7021-266	UltraPower Fine Round Diamond Bur	64

<b>Cat. No.</b>	<b>Description</b>	<b>Page No.</b>
7021-267	UltraPower® Fine Round Diamond Bur	64
7021-272	UltraPower Coarse Round Diamond Bur	65
7021-273	UltraPower Coarse Round Diamond Bur	65
7021-274	UltraPower Coarse Round Diamond Bur	65
7021-275	UltraPower Coarse Round Diamond Bur	65
7021-276	UltraPower Coarse Round Diamond Bur	65
7021-277	UltraPower Coarse Round Diamond Bur	65
7021-279	UltraPower Fine Diamond Cylindrical Bur	67
7021-280	UltraPower Fluted Acorn Bur	67
7021-281	UltraPower Fluted Acorn Bur	67
7021-282	UltraPower Fluted Acorn Bur	67
7021-283	UltraPower Fluted Acorn Bur	67
7021-292	UltraPower Fine Diamond Wheels for Metal Cutting Bur	68
7021-294	UltraPower Carbide Metal Cutting Bur	68
7021-295	UltraPower Oval Fluted Bur	68
7021-296	UltraPower Oval Fluted Bur	68
7021-297	UltraPower Carbide Metal Cutting Bur	68
7021-301	UltraPower Side Cutting Bur	66
7021-302	UltraPower Side Cutting Bur	65
7021-303	UltraPower Side Cutting Bur	65
7021-305	UltraPower Side Cutting Bur	65
7021-309	UltraPower Side Cutting Bur	65
7021-310	UltraPower Side Cutting Bur	65
7021-314	UltraPower Side Cutting Bur	66
7021-315	UltraPower Side Cutting Bur	66
7021-318	UltraPower Side Cutting Bur	66
7021-322	UltraPower Round Fluted Bur	64
7021-323	UltraPower Round Fluted Bur	64
7021-324	UltraPower Round Fluted Bur	64
7021-325	UltraPower Round Fluted Bur	64
7021-326	UltraPower Round Fluted Bur	64
7021-327	UltraPower Round Fluted Bur	64
7021-328	UltraPower Round Fluted Bur	64
7021-329	UltraPower Round Fluted Bur	64
7021-331	UltraPower Round Fluted Bur	64
7021-332	UltraPower Round Fluted Bur	64
7021-333	UltraPower Round Fluted Bur	64
7021-335	UltraPower Fluted Cylindrical Bur	66
7021-336	UltraPower Fluted Cylindrical Bur	66
7021-337	UltraPower Fluted Cylindrical Bur	66
7021-338	UltraPower Fluted Cylindrical Bur	66
7021-361	UltraPower Fine Round Diamond Bur	64
7021-362	UltraPower Fine Round Diamond Bur	64
7021-363	UltraPower Fine Round Diamond Bur	64
7021-364	UltraPower Fine Round Diamond Bur	64
7021-365	UltraPower Fine Round Diamond Bur	64
7021-366	UltraPower Fine Round Diamond Bur	64
7021-367	UltraPower Fine Round Diamond Bur	64
7021-371	UltraPower Coarse Round Diamond Bur	65
7021-372	UltraPower Coarse Round Diamond Bur	65
7021-373	UltraPower Coarse Round Diamond Bur	65
7021-374	UltraPower Coarse Round Diamond Bur	65
7021-375	UltraPower Coarse Round Diamond Bur	65
7021-376	UltraPower Coarse Round Diamond Bur	65

<b>Cat. No.</b>	<b>Description</b>	<b>Page No.</b>
7021-377	UltraPower® Coarse Round Diamond Bur	65
7021-378	UltraPower Fine Diamond Cylindrical Bur	67
7021-379	UltraPower Fine Diamond Cylindrical Bur	67
7021-380	UltraPower Fluted Acorn Bur	67
7021-381	UltraPower Fluted Acorn Bur	67
7021-382	UltraPower Fluted Acorn Bur	67
7021-383	UltraPower Fluted Acorn Bur	67
7021-391	UltraPower Fluted Frustrum Bur	68
7021-392	UltraPower Fine Diamond Wheels for Metal Cutting Bur	68
7021-395	UltraPower Oval Fluted Bur	68
7021-396	UltraPower Oval Fluted Bur	68
7021-408	UltraPower Side Cutting Bur	65
7021-409	UltraPower Side Cutting Bur	65
7021-426	UltraPower Round Fluted Bur	64
7021-427	UltraPower Round Fluted Bur	64, 65
7021-428	UltraPower Round Fluted Bur	64
7021-429	UltraPower Round Fluted Bur	64
7021-431	UltraPower Round Fluted Bur	64
7021-432	UltraPower Round Fluted Bur	64
7021-433	UltraPower Round Fluted Bur	64
7021-437	UltraPower Fluted Cylindrical Bur	66
7021-474	UltraPower Coarse Round Diamond Bur	65
7021-482	UltraPower Fluted Acorn Bur	67
7021-483	UltraPower Fluted Acorn Bur	67
7021-492	UltraPower Fine Diamond Wheels for Metal Cutting Bur	68
7021-509	UltraPower Side Cutting Bur	65
7021-526	UltraPower Round Fluted Bur	64
7021-528	UltraPower Round Fluted Bur	64
7021-529	UltraPower Round Fluted Bur	64
7021-531	UltraPower Round Fluted Bur	64
7021-532	UltraPower Round Fluted Bur	64
7021-533	UltraPower Round Fluted Bur	64
7021-581	UltraPower Fluted Acorn Bur	67
7021-583	UltraPower Fluted Acorn Bur	67
7021-631	UltraPower Round Fluted Bur	64
7021-632	UltraPower Round Fluted Bur	64
7021-633	UltraPower Round Fluted Bur	64
7021-681	UltraPower Fluted Acorn Bur	67
7021-683	UltraPower Fluted Acorn Bur	67
7021-713	E Neuro Bur	63, 66
7021-815	E Neuro Bur	63, 66
7021-917	E Neuro Bur	63, 66
7021-960	E Helical Bur for E9010 Drill	63
7307-03	Staplizer® Cartridge	57
7310-03	Staplizer Cartridge	57
7315-03	Staplizer Cartridge	57
7320-03	Staplizer Cartridge	57
7610-03	Staplizer Cartridge	57
7615-03	Staplizer Cartridge	57
7620-03	Staplizer Cartridge	57
7625-03	Staplizer Cartridge	57
7707-03	Staplizer Cartridge	57
7710-03	Staplizer Cartridge	57
A201	10' (3.05m) Hose for Staplizer Handpiece	10, 23



<b>Cat. No.</b>	<b>Description</b>	<b>Page No.</b>
A9350	Rhinotec <sup>®</sup> Cuda <sup>®</sup> Blade	58
A9360	Rhinotec Gator <sup>®</sup> Blade	59
C8803	MicroPower <sup>®</sup> & Micro 100 <sup>™</sup> ACL Sagittal Saw Blade	50
C8804	MicroPower & Micro 100 ACL Sagittal Saw Blade	50
C8806	MicroPower & Micro 100 ACL Sagittal Saw Blade	50
C9863	3-Pedal Footswitch	9
C9911	Rhinotec Spherical Bur, Hooded	61
C9912	Rhinotec Spherical Bur, Hooded	61
C9950	Rhinotec Cuda Blade	58
C9951	Rhinotec Cuda Blade	58
C9952	Rhinotec Cuda Blade	58
C9960	Rhinotec Gator Blade	59
C9961	Rhinotec Gator Blade	59
C9962	Rhinotec Gator Blade	59
C9990	Rhinotec Vortex <sup>®</sup> Router	60
C9991	Rhinotec Vortex Router	60
D3000	Advantage <sup>®</sup> Console	8
D4000	D4000 Console	8
E4110	E Wirepass Bur	63
E4115	E Wirepass Bur	63
E4120	E Wirepass Bur	63
E4208	E9010 Side Cutting Burs	63
E4217	E9010 Lindemann Bur	63
E4220	E9010 Side Cutting Burs	63
E5050	E Coarse Round Diamond Bur	62
E5120	E Coarse Round Diamond Bur	62
E5130	E Coarse Round Diamond Bur	62
E5140	E Coarse Round Diamond Bur	62
E5150	E Coarse Round Diamond Bur	62
E5160	E Coarse Round Diamond Bur	62
E5170	E Coarse Round Diamond Bur	62
E5210	E Coarse Round Diamond Bur	62
E5215	E Coarse Round Diamond Bur	62
E5220	E Coarse Round Diamond Bur	62
E5225	E Coarse Round Diamond Bur	62
E5230	E Coarse Round Diamond Bur	62
E5240	E Coarse Round Diamond Bur	62
E6040	E Fine Round Diamond Bur	62
E6105	E Fine Round Diamond Bur	62
E6110	E Fine Round Diamond Bur	62
E6115	E Fine Round Diamond Bur	62
E6120	E Fine Round Diamond Bur	62
E6125	E Fine Round Diamond Bur	62
E6130	E Fine Round Diamond Bur	62
E6140	E Fine Round Diamond Bur	62
E6150	E Fine Round Diamond Bur	62
E6160	E Fine Round Diamond Bur	62
E6205	E Fine Round Diamond Bur	62
E6207	E Fine Round Diamond Bur	62
E6210	E Fine Round Diamond Bur	62
E6215	E Fine Round Diamond Bur	62
E6220	E Fine Round Diamond Bur	62
E6225	E Fine Round Diamond Bur	62
E6230	E Fine Round Diamond Bur	62

<b>Cat. No.</b>	<b>Description</b>	<b>Page No.</b>
E6240	E Fine Round Diamond Bur	62
E6250	E Fine Round Diamond Bur	62
E8007	E Round Fluted Bur	62
E8010	E Round Fluted Bur	62
E8015	E Round Fluted Bur	62
E8020	E Round Fluted Bur	62
E8025	E Round Fluted Bur	62
E8030LSO	E LSO Round Fluted Bur	62
E8040LSO	E LSO Round Fluted Bur	62
E8050LSO	E LSO Round Fluted Bur	62
E8065LSO	E LSO Round Fluted Bur	62
E8105	E Round Fluted Bur	62
E8110	E Round Fluted Bur	62
E8115	E Round Fluted Bur	62
E8120	E Round Fluted Bur	62
E8125	E Round Fluted Bur	62
E8130LSO	E LSO Round Fluted Bur	62
E8140LSO	E LSO Round Fluted Bur	62
E8150LSO	E LSO Round Fluted Bur	62
E8165LSO	E LSO Round Fluted Bur	62
E8205	E Round Fluted Bur	62
E8207	E Round Fluted Bur	62
E8210	E Round Fluted Bur	62
E8215	E Round Fluted Bur	62
E8220	E Round Fluted Bur	62
E8225	E Round Fluted Bur	62
E8230LSO	E LSO Round Fluted Bur	62
E8240LSO	E LSO Round Fluted Bur	62
E8265LSO	E LSO Round Fluted Bur	62
E9000	E9000 <sup>®</sup> Console	8
E9005	High Speed Shaver	18
E9010	CoolFlex <sup>®</sup> High Speed Drill	18
E9011-1	Medium Bur Guard for E9010 Drill	18
E9011-2	Long Bur Guard for E9010 Drill	18
E9011-3	X-Long Bur Guard for E9010 Drill	18
E9011-7	Short Neuro Guard for E9010 Drill	18
E9011-8	Medium Neuro Guard for E9010 Drill	18
E9011-9	Long Neuro Guard for E9010 Drill	18
E9012	Locking Collar for E9010 Drill	18
E9015	Cranial Perforator Drive	18
E9315	DeClogger for removing tissue and bone from shaver blades and burs	18
E9323	Bur Rack, Holds up to 20 burs for E9010 Drill	18
E9350	RhinoTec <sup>®</sup> Cuda <sup>®</sup> Blade	58
E9351	RhinoTec Cuda Blade	58
E9360	RhinoTec Gator Blade	59
E9361	RhinoTec Gator <sup>®</sup> Blade	59
E9363	Laryngeal Blade	59
E9414	Drill Tubing for E9010 Drill without irrigation tip	18
E9415A	Drill Tubing for E9010 Drill with irrigation tip	18
E9416	4.2mm FESS Irrigation Tubing Set for E9005 Shaver	18
E9417	3.7mm FESS Irrigation Tubing Set for E9005 Shaver (Not Shown)	18
E9418	Irrigation Tubing Set	15
L10D	MicroPower <sup>®</sup> & Micro 100 <sup>®</sup> Fine Round Diamond Small Bone Bur	54
L12T	MicroPower & Micro 100 Tapered Side-cutting Small Bone Bur	55

Cat. No.	Description	Page No.
L13S	MicroPower™ & Micro 100™ Straight Side – Cutting Small Bone Bur	55
L17S	MicroPower & Micro 100 Straight Side – Cutting Small Bone Bur	55
L18R	MicroPower & Micro 100 Round Fluted Small Bone Bur	54
L20T	MicroPower & Micro 100 Tapered Side-cutting Small Bone Bur	55
L23R	MicroPower & Micro 100 Round Fluted Small Bone Bur	54
L3000	Hall™ Lithium Charger	6
L3000LG	Hall Lithium Battery	6
L40B	MicroPower & Micro 100 Oval Small Bone Bur	55
L45C	MicroPower & Micro 100 Cone Small Bone Bur	56
L55B	MicroPower & Micro 100 Oval Small Bone Bur	55
L60R	MicroPower & Micro 100 Round Fluted Small Bone Bur	54
M105A	Blitz™ Instrument Cleaner (Use with Staplizer® Handpiece)	10
M10S	MicroPower & Micro 100 Straight Side – Cutting Small Bone Bur	55
M12T	MicroPower & Micro 100 Tapered Side-cutting Small Bone Bur	55
M13S	MicroPower & Micro 100 Straight Side – Cutting Small Bone Bur	55
M15S	MicroPower & Micro 100 Straight Side – Cutting Small Bone Bur	55
M17S	MicroPower & Micro 100 Straight Side – Cutting Small Bone Bur	55
M207	Regulator, Single Connection	10
M208	Regulator, Dual Connection	10
M20T	MicroPower & Micro 100 Tapered Side-cutting Small Bone Bur	55
M317	Instrument Lubricant for Staplizer	10
M322	DISS to Schrader Adapter	10
M40B	MicroPower & Micro 100 Oval Small Bone Bur	55
M45C	MicroPower & Micro 100 Cone Small Bone Bur	56
M55B	MicroPower & Micro 100 Oval Small Bone Bur	55
M60D	MicroPower & Micro 100 Fine Round Diamond Small Bone Bur	54
M60R	MicroPower & Micro 100 Round Fluted Small Bone Bur	54
MC5057	Handpiece Cord	9
N9150	Lynx™ Blade	58
N9210	Rhinotec™ Cuda™ Blade	58
N9220	Rhinotec Gator™ Blade	59
N9320	Head & Neck Blade	59
N9321	Head & Neck Blade	59
N9330	MicroXcisor™ Blade	58
N9375	Curved Vortex Router	60
N9380	Rhinotec Spherical Bur, Hooded	61
N9382	Rhinotec Spherical Bur, Unhooded	61
N9385	Rhinotec Spherical Diamond Bur, Hooded	61
N9390	Otolaryngology Bur	60
PRO1540	Drill-Ream Attachment, AO	14
PRO1541	Drill-Ream Attachment, 1/4" (6.35mm) Chuck	14
PRO1545	Drill-Ream Attachment, DePuy/Hudson	14
PRO1547	Drill-Ream Attachment, Zimmer/Hudson	14
PRO2000	PowerPro™ Console	8
PRO2029	AO/Trinkle	14
PRO2030	5/32" (4.0mm) Jacobs Chuck, with Chuck Key	14
PRO2033	High Speed Drill Attachment	14
PRO2038	Small AO–Low Profile	14
PRO2039	Mini AO	14
PRO2040	3:1 Large AO Reamer	14
PRO2041	1/4" (6.35mm) Jacobs Chuck	14
PRO2042	3:1 1/4" High Torque Jacobs Chuck	14
PRO2043	Sagittal Saw Attachment	14
PRO2046	Zimmer/Hudson	14

<b>Cat. No.</b>	<b>Description</b>	<b>Page No.</b>
PR02047	3:1 Zimmer/Hudson Reamer	14
PR02060	3:1 Aesculap Reamer	14
PR02065	3:1 Hudson Reamer (DePuy)	14
PR02070	Large AO	14
PR02075	Standard Hudson (DePuy)	14
PR02080	3:1 DHS Reamer	14
PR02138	Small AO—One Handed Operation	14
PR02250	1/4" Keyless Chuck	14
PR02329	3:1 Trinkle Reamer	14
PR02514	Radiolucent Drive Adaptor	14
PR03010	Large NiCad Battery, 9.6 Volt	6
PR03011	X-Large NiCad Battery, 12 Volt	6
PR03020	Small NiCad Battery, 12 Volt	6
PR03110	Battery Case for PR03115	7
PR03115	Large NiMH Sterile Transfer Battery, 9.6 Volt	7
PR03130	Transfer Shroud for PR03110	7
PR03135	Charging Platform for PR03115	7
PR03520	Small NiMH Sterile Transfer Battery, 12 Volt	7
PR03521	Battery Case for PR03520	7
PR03531	Transfer Shroud for PR03521	7
PR03535	Charging Platform for PR03520	7
PR03600	Battery Charger	6
PR05095	Large Bone Tray	24
PR06000	Small Bone Tray	24
PR06001	Large Bone Tray with Battery Holders	24
PR06040	5:1 Large AO Reamer	14
PR06042	5:1 1/4" High Torque Jacobs Chuck	14
PR06045	Reciprocating Saw Attachment for PRO6100, PRO6150, PRO6200M, & PRO6202M	14
PR06047	5:1 Zimmer/Hudson Reamer	14
PR06048	5:1 Hudson Reamer(DePuy)	14
PR06050	1/8" Keyless Chuck	14
PR06060	5:1 Aesculap Reamer	14
PR06100	PowerPro Electric II™ Single Trigger Modular Handpiece	12
PR06125	PowerPro® Oscillating Saw	12
PR06128	Wire Driver for PRO6200 Range: 0.7 – 1.6mm (0.028 – 0.062")	11 - 13
PR06135	PowerPro Electric II Reciprocating Saw	12
PR06140	Pin Driver for PRO6200 Range: 1.8 – 4.0mm (0.071 – 0.157")	11 - 13
PR06150	PowerPro Pneumatic Single Trigger Modular Handpiece	13
PR06175	PowerPro Pneumatic Oscillating Saw	13
PR06185	PowerPro Pneumatic Reciprocating Saw	13
PR06200M	Mpower® 2 Single Trigger Modular Handpiece	11
PR06202M	Mpower 2 2-Trigger Modular Handpiece	11
PR06228	Wire Driver for PRO6202 Range: 0.7 – 1.6mm (0.028 – 0.062")	11
PR06240	Pin Driver for PRO6202 Range: 1.8 – 4.0mm (0.071 – 0.157")	11
PR06350M	Mpower 2 Oscillating Saw	11
PR06400M	Mpower 2 Reciprocating Saw	11
PR06450M	Mpower 2 Battery Sternum Saw	21
PR07020	Multipurpose High Speed	14
T100	Staplizer® Handpiece	23
T107	Staplizer Carrier, 7mm	23
T110	Staplizer Carrier, 10mm	23
T113	Staplizer Carrier, 13mm	23
T116	Staplizer Carrier, 16mm	23
T121	Staple Pry	23

<b>Cat. No.</b>	<b>Description</b>	<b>Page No.</b>
T122	Staple Seater	23
T123	Width Guage	23
T301	Punch Disassembly Tool	23
T307	Drill Guide, 7mm	23
T310	Drill Guide, 10mm	23
T313	Drill Guide, 13mm	23
T316	Drill Guide, 16mm	23
TN130-089-90	M-Class® Blade	29
TN130-100-90	M-Class Blade	29
TN130-107-90	M-Class Blade	29
TN130-119-90	M-Class Blade	29
TN130-127-90	M-Class Blade	29
TN130-137-90	M-Class Blade	29
TN130-147-90	M-Class Blade	29
TN190-089-90	M-Class Blade	29
TN190-100-90	M-Class Blade	29
TN190-107-90	M-Class Blade	29
TN190-119-05	M-Class Blade	29
TN190-119-90	M-Class Blade	29
TN190-127-05	M-Class Blade	29
TN190-127-90	M-Class Blade	29
TN190-137-05	M-Class Blade	29
TN190-137-90	M-Class Blade	29
TN190-147-90	M-Class Blade	29
TN193-119-90	M-Class Blade	29
TN193-127-90	M-Class Blade	29
TN193-137-90	M-Class Blade	29
TN250-089-90	M-Class Blade	29
TN250-100-90	M-Class Blade	29
TN250-107-90	M-Class Blade	29
TN250-119-90	M-Class Blade	29
TN250-127-90	M-Class Blade	29
TN250-137-90	M-Class Blade	29
TN250-147-90	M-Class Blade	29
V130-089-90	Hall® Classic Blade	30
V130-100-90	Hall Classic Blade	30
V130-107-90	Hall Classic Blade	30
V130-119-90	Hall Classic Blade	30
V130-127-90	Hall Classic Blade	30
V130-137-90	Hall Classic Blade	30
V130-147-90	Hall Classic Blade	30
V190-089-05	Hall Classic Blade	30
V190-089-90	Hall Classic Blade	30
V190-100-05	Hall Classic Blade	30
V190-100-90	Hall Classic Blade	30
V190-107-05	Hall Classic Blade	30
V190-107-90	Hall® Classic Blade	30
V190-119-05	Hall Classic Blade	30
V190-119-90	Hall Classic Blade	30
V190-127-05	Hall Classic Blade	30
V190-127-90	Hall Classic Blade	30
V190-137-05	Hall Classic Blade	30
V190-137-90	Hall Classic Blade	30
V190-147-05	Hall Classic Blade	30

<b>Cat. No.</b>	<b>Description</b>	<b>Page No.</b>
V190-147-90	Hall Classic Blade	30
V193-119-90	Hall Classic Blade	30
V193-127-90	Hall Classic Blade	30
V193-137-90	Hall Classic Blade	30
V250-089-90	Hall Classic Blade	30
V250-100-90	Hall Classic Blade	30
V250-107-90	Hall Classic Blade	30
V250-119-90	Hall Classic Blade	30
V250-127-90	Hall Classic Blade	30
V250-137-90	Hall Classic Blade	30
V250-147-90	Hall Classic Blade	30
X10D	MicroPower® & Micro 100™ Fine Round Diamond Small Bone Bur	54
X40B	MicroPower & Micro 100 Oval Small Bone Bur	55
X55B	MicroPower & Micro 100 Oval Small Bone Bur	55
X60R	MicroPower & Micro 100 Round Fluted Small Bone Bur	54

# Alphabetical Index



Cat. No.	Description	Page No.
PR02041	1/4" (6.35mm) Jacobs Chuck	14
5044-999-52	1/4" (6.35mm) Replacement Chuck Key	14
PR02250	1/4" Keyless Chuck	14
PR06050	1/8" Keyless Chuck	14
A201	10' (3.05m) Hose for Staplizer® Handpiece	10, 23
5020-053	2-Pedal Footswitch	9
7020-024	20 degree Angle X-Long Keyless Attachment	19, 25, 26
1375-032	20 degree Angled Attachment	15
7020-023	20 degree Long Keyless Attachment	19, 25, 26
1375-033	20 degree X-Long Angled Attachment	15
C9863	3-Pedal Footswitch	9
PR02042	3:1 1/4" High Torque Jacobs Chuck	14
PR02060	3:1 Aesculap Reamer	14
PR02080	3:1 DHS Reamer	14
PR02065	3:1 Hudson Reamer (DePuy)	14
PR02040	3:1 Large AO Reamer	14
PR02329	3:1 Trinkle Reamer	14
PR02047	3:1 Zimmer/Hudson Reamer	14
E9417	3.7mm FESS Irrigation Tubing Set for E9005 Shaver (Not Shown)	18
E9416	4.2mm FESS Irrigation Tubing Set for E9005 Shaver	18
PR06042	5:1 1/4" High Torque Jacobs Chuck	14
PR06060	5:1 Aesculap Reamer	14
PR06048	5:1 Hudson Reamer(DePuy)	14
PR06040	5:1 Large AO Reamer	14
PR06047	5:1 Zimmer/Hudson Reamer	14
PR02030	5/32" (4.0mm) Jacobs Chuck, with Chuck Key	14
5044-999-53	5/32" (4.0mm) Replacement Chuck Key	14
1375-034	70 degree Contra Angle with Dental Head	15
1375-035	70 degree Contra Angle with Surgical Head	15
7020-022	90 degree Angle Attachment (like Midas AF/BF)	19, 25, 26
1375-036	90 degree Angled Attachment	15
5039-003	AC Power Cord	9
5071-127	ACL Large Bone Oscillating Blade	42
5071-133	ACL Large Bone Oscillating Blade	42
5071-134	ACL Large Bone Oscillating Blade	42
5071-135	ACL Large Bone Oscillating Blade	42
5071-236	ACL Large Bone Oscillating Blade	42
5071-246	ACL Large Bone Oscillating Blade	42
5071-571	ACL Large Bone Oscillating Blade	42
D3000	Advantage® Console	8
PR02029	AO/Trinkle	14
7020-041	Attachment Spray	25, 26
PR03110	Battery Case for PR03115	7
PR03521	Battery Case for PR03520	7
PR03600	Battery Charger	6
M105A	Blitz® Instrument Cleaner (Use with Staplizer Handpiece)	10
1375-015	Bur Brush	24, 25, 27, 28
7020-046	Bur Cabinet for Neuro Burs	18, 25, 26
1375-003	Bur Changer for 70 and 90 degree Angled Attachments	15
E9323	Bur Rack, Holds up to 20 burs for E9010 Drill	18
1375-112	Burguard Sleeve Surgairtome Two	17
5050-041	C-Wire	57
5050-042	C-Wire	57
5050-043	C-Wire	57

Cat. No.	Description	Page No.
5050-044	C-Wire	57
5050-046	C-Wire	57
5050-047	C-Wire	57
5050-048	C-Wire	57
5050-049	C-Wire	57
5052-042	Cebotome® Bur Extension, Short	22, 28
5052-046	Cebotome Bur Wrench	22, 28
5052-142	Cebotome Metal Cutting Bur Extension	22, 28
5052-143	Cebotome Metal Cutting Bur Wrench	22, 28
5052-125	Cebotome Metal Cutting Wheel	28, 70
5052-129	Cebotome Metal Cutting Wheel Wrench	28
5052-126	Cebotome Metal Trimming Wheel	28, 70
5052-041	Cebotome Revision Drill Handpiece	22, 28
5052-181	Cebotome Bur	70
5052-182	Cebotome Bur	70
5052-183	Cebotome Bur	70
5052-184	Cebotome Bur	70
5052-185	Cebotome Bur	70
5052-186	Cebotome Bur	70
5052-187	Cebotome Bur	70
5052-188	Cebotome Bur	70
5052-189	Cebotome Bur	70
5052-190	Cebotome Bur	70
5052-191	Cebotome Bur	70
5052-192	Cebotome Bur	70
PR03135	Charging Platform for PR03115	7
PR03535	Charging Platform for PR03520	7
5053-124	Cleaning Brush for Cannulated Handpieces	24
5020-054	Console Stand	9
E9010	CoolFlex® High Speed Drill	18
E9015	Cranial Perforator Drive	18
N9375	Curved Vortex® Router	60
D4000	D4000 Console	8
E9315	DeClogger for removing tissue and bone from shaver blades and burs	18
M322	DISS to Schrader Adapter	10
T310	Drill Guide, 10mm	23
T313	Drill Guide, 13mm	23
T316	Drill Guide, 16mm	23
T307	Drill Guide, 7mm	23
E9415A	Drill Tubing for E9010 Drill with irrigation tip	18
E9414	Drill Tubing for E9010 Drill without irrigation tip	18
PR01541	Drill-Ream Attachment, 1/4" (6.35mm) Chuck	14
PR01540	Drill-Ream Attachment, AO	14
PR01545	Drill-Ream Attachment, DePuy/Hudson	14
PR01547	Drill-Ream Attachment, Zimmer/Hudson	14
E5050	E Coarse Round Diamond Bur	62
E5120	E Coarse Round Diamond Bur	62
E5130	E Coarse Round Diamond Bur	62
E5140	E Coarse Round Diamond Bur	62
E5150	E Coarse Round Diamond Bur	62
E5160	E Coarse Round Diamond Bur	62
E5170	E Coarse Round Diamond Bur	62
E5210	E Coarse Round Diamond Bur	62
E5215	E Coarse Round Diamond Bur	62



# Alphabetical Index



<b>Cat. No.</b>	<b>Description</b>	<b>Page No.</b>
E5220	E Coarse Round Diamond Bur	62
E5225	E Coarse Round Diamond Bur	62
E5230	E Coarse Round Diamond Bur	62
E5240	E Coarse Round Diamond Bur	62
E6040	E Fine Round Diamond Bur	62
E6105	E Fine Round Diamond Bur	62
E6110	E Fine Round Diamond Bur	62
E6115	E Fine Round Diamond Bur	62
E6120	E Fine Round Diamond Bur	62
E6125	E Fine Round Diamond Bur	62
E6130	E Fine Round Diamond Bur	62
E6140	E Fine Round Diamond Bur	62
E6150	E Fine Round Diamond Bur	62
E6160	E Fine Round Diamond Bur	62
E6205	E Fine Round Diamond Bur	62
E6207	E Fine Round Diamond Bur	62
E6210	E Fine Round Diamond Bur	62
E6215	E Fine Round Diamond Bur	62
E6220	E Fine Round Diamond Bur	62
E6225	E Fine Round Diamond Bur	62
E6230	E Fine Round Diamond Bur	62
E6240	E Fine Round Diamond Bur	62
E6250	E Fine Round Diamond Bur	62
7021-960	E Helical Bur for E9010 Drill	63
E8030LSO	E LSO Round Fluted Bur	62
E8040LSO	E LSO Round Fluted Bur	62
E8050LSO	E LSO Round Fluted Bur	62
E8065LSO	E LSO Round Fluted Bur	62
E8130LSO	E LSO Round Fluted Bur	62
E8140LSO	E LSO Round Fluted Bur	62
E8150LSO	E LSO Round Fluted Bur	62
E8165LSO	E LSO Round Fluted Bur	62
E8230LSO	E LSO Round Fluted Bur	62
E8240LSO	E LSO Round Fluted Bur	62
E8265LSO	E LSO Round Fluted Bur	62
7021-713	E Neuro Bur	63, 66
7021-815	E Neuro Bur	63, 66
7021-917	E Neuro Bur	63, 66
E8007	E Round Fluted Bur	62
E8010	E Round Fluted Bur	62
E8015	E Round Fluted Bur	62
E8020	E Round Fluted Bur	62
E8025	E Round Fluted Bur	62
E8105	E Round Fluted Bur	62
E8110	E Round Fluted Bur	62
E8115	E Round Fluted Bur	62
E8120	E Round Fluted Bur	62
E8125	E Round Fluted Bur	62
E8205	E Round Fluted Bur	62
E8207	E Round Fluted Bur	62
E8210	E Round Fluted Bur	62
E8215	E Round Fluted Bur	62
E8220	E Round Fluted Bur	62
E8225	E Round Fluted Bur	62

Cat. No.	Description	Page No.
E4110	E Wirepass Bur	63
E4115	E Wirepass Bur	63
E4120	E Wirepass Bur	63
E9000	E9000* Console	8
E4217	E9010 Lindemann Bur	63
E4208	E9010 Side Cutting Burs	63
E4220	E9010 Side Cutting Burs	63
5052-029	Extension Hose, 10' (3.05m), Male Diss and Female Schrader	10
5052-018	Extension Hose, 10' (3.05m), Male Schrader to Female Schrader	10
5040-180	Fluid Bag Support Rod for D3000 & E9000	9
5071-105	Graft Harvesting Large Bone Oscillating Blade	42
5071-106	Graft Harvesting Large Bone Oscillating Blade	42
5071-107	Graft Harvesting Large Bone Oscillating Blade	42
5071-108	Graft Harvesting Large Bone Oscillating Blade	42
5071-109	Graft Harvesting Large Bone Oscillating Blade	42
5071-110	Graft Harvesting Large Bone Oscillating Blade	42
5071-111	Graft Harvesting Large Bone Oscillating Blade	42
5071-112	Graft Harvesting Large Bone Oscillating Blade	42
5071-113	Graft Harvesting Large Bone Oscillating Blade	42
L3000LG	Hall® Lithium Battery	6
1365-016	Hall Lubricant for Angled Attachments	10
1375-037	Hall Lubricant for Surgical Angled Attachments	10
5071-120	Hall Large Bone Knee Blade	32, 34
5071-121	Hall Large Bone Knee Blade	32, 34
5071-123	Hall Large Bone Knee Blade	32, 37
5071-124	Hall Large Bone Knee Blade	32, 38
5071-129	Hall Large Bone Knee Blade	32, 38
5071-144	Hall Large Bone Knee Blade	32, 38
5071-146	Hall Large Bone Knee Blade	32, 34
5071-161	Hall Large Bone Knee Blade	32, 37
5071-163	Hall Large Bone Knee Blade	32, 38
5071-167	Hall Large Bone Knee Blade	32, 35
5071-180	Hall Large Bone Knee Blade	32, 36
5071-181	Hall Large Bone Knee Blade	32, 36
5071-184	Hall Large Bone Knee Blade	32, 35
5071-185	Hall Large Bone Knee Blade	32, 33
5071-195	Hall Large Bone Knee Blade	32, 34
5071-196	Hall Large Bone Knee Blade	32, 34
5071-201	Hall Large Bone Knee Blade	32, 36
5071-519	Hall Large Bone Knee Blade	32, 37
5071-525	Hall Large Bone Knee Blade	32, 38
5071-526	Hall Large Bone Knee Blade	32, 35
5071-527	Hall Large Bone Knee Blade	32, 36
5071-528	Hall Large Bone Knee Blade	32, 33
5071-529	Hall Large Bone Knee Blade	32, 38
5071-530	Hall Large Bone Knee Blade	32, 38
5071-531	Hall Large Bone Knee Blade	32, 36
5071-532	Hall Large Bone Knee Blade	32, 33
5071-533	Hall Large Bone Knee Blade	32, 33
5071-534	Hall Large Bone Knee Blade	32, 35
5071-538	Hall Large Bone Knee Blade	32, 34
5071-539	Hall Large Bone Knee Blade	32, 38
5071-547	Hall Large Bone Knee Blade	32, 35
5071-548	Hall Large Bone Knee Blade	32, 34

# Alphabetical Index



<b>Cat. No.</b>	<b>Description</b>	<b>Page No.</b>
5071-558	Hall® Large Bone Knee Blade	32, 35
5071-562	Hall Large Bone Knee Blade	32, 34
5071-564	Hall Large Bone Knee Blade	32, 37
5071-565	Hall Large Bone Knee Blade	32, 38
5071-568	Hall Large Bone Knee Blade	32, 37
5071-570-50	Hall Large Bone Knee Blade	32, 35
5071-573	Hall Large Bone Knee Blade	32, 35
5071-576	Hall Large Bone Knee Blade	32, 37
5071-582	Hall Large Bone Knee Blade	32, 36
5071-583	Hall Large Bone Knee Blade	32, 33
5071-589	Hall Large Bone Knee Blade	32, 33
5071-590	Hall Large Bone Knee Blade	32, 37
5071-594	Hall Large Bone Knee Blade	32, 33
5271-502	Hall Large Bone Knee Blade	32, 33
5271-561	Hall Large Bone Knee Blade	32, 37
5271-580	Hall Large Bone Knee Blade	32, 36
V130-089-90	Hall Classic Blade	30
V130-100-90	Hall Classic Blade	30
V130-107-90	Hall Classic Blade	30
V130-119-90	Hall Classic Blade	30
V130-127-90	Hall Classic Blade	30
V130-137-90	Hall Classic Blade	30
V130-147-90	Hall Classic Blade	30
V190-089-05	Hall Classic Blade	30
V190-089-90	Hall Classic Blade	30
V190-100-05	Hall Classic Blade	30
V190-100-90	Hall Classic Blade	30
V190-107-05	Hall Classic Blade	30
V190-107-90	Hall Classic Blade	30
V190-119-05	Hall Classic Blade	30
V190-119-90	Hall Classic Blade	30
V190-127-05	Hall Classic Blade	30
V190-127-90	Hall Classic Blade	30
V190-137-05	Hall Classic Blade	30
V190-137-90	Hall Classic Blade	30
V190-147-05	Hall Classic Blade	30
V190-147-90	Hall Classic Blade	30
V193-119-90	Hall Classic Blade	30
V193-127-90	Hall Classic Blade	30
V193-137-90	Hall Classic Blade	30
V250-089-90	Hall Classic Blade	30
V250-100-90	Hall Classic Blade	30
V250-107-90	Hall Classic Blade	30
V250-119-90	Hall Classic Blade	30
V250-127-90	Hall Classic Blade	30
V250-137-90	Hall Classic Blade	30
V250-147-90	Hall Classic Blade	30
5052-173	Hall Large Bone Reciprocating Blade	47
5052-179	Hall Large Bone Reciprocating Blade	47
5052-258	Hall Large Bone Reciprocating Blade	47
5052-259	Hall Large Bone Reciprocating Blade	47
5052-260	Hall Large Bone Reciprocating Blade	47
5052-261	Hall Large Bone Reciprocating Blade	47
5052-276	Hall Large Bone Reciprocating Blade	47

<b>Cat. No.</b>	<b>Description</b>	<b>Page No.</b>
5052-281	Hall® Large Bone Reciprocating Blade	47
5052-291	Hall Large Bone Reciprocating Blade	47
L3000	Hall Lithium Charger	6
MC5057	Handpiece Cord	9
N9320	Head & Neck Blade	59
N9321	Head & Neck Blade	59
PR02033	High Speed Drill Attachment	14
E9005	High Speed Shaver	18
5030-029	Holding Clamp Medium	24
5030-028	Holding Clamp Small	24
M317	Instrument Lubricant for Staplizer®	10
5071-300	Intrex® Blade	31
5071-301	Intrex Blade	31
5071-302	Intrex Blade	31
5071-303	Intrex Blade	31
5071-304	Intrex Blade	31
5071-305	Intrex Blade	31
5071-306	Intrex Blade	31
5071-310	Intrex Blade	31
5071-311	Intrex Blade	31
5071-312	Intrex Blade	31
5071-313	Intrex Blade	31
5071-314	Intrex Blade	31
5071-315	Intrex Blade	31
5071-316	Intrex Blade	31
5071-320	Intrex Blade	31
5071-321	Intrex Blade	31
5071-322	Intrex Blade	31
5071-323	Intrex Blade	31
5071-324	Intrex Blade	31
5071-325	Intrex Blade	31
5071-326	Intrex Blade	31
5071-330	Intrex Blade	31
5071-331	Intrex Blade	31
5071-332	Intrex Blade	31
5071-333	Intrex Blade	31
5071-334	Intrex Blade	31
5071-335	Intrex Blade	31
5071-336	Intrex Blade	31
5071-340	Intrex Blade	31
5071-341	Intrex Blade	31
5071-342	Intrex Blade	31
5071-343	Intrex Blade	31
5071-344	Intrex Blade	31
5071-345	Intrex Blade	31
5071-346	Intrex Blade	31
5071-350	Intrex Blade	31
5071-351	Intrex Blade	31
5071-352	Intrex Blade	31
5071-353	Intrex Blade	31
5071-354	Intrex Blade	31
5071-355	Intrex Blade	31
5071-356	Intrex Blade	31
E9418	Irrigation Tubing Set	15

# Alphabetical Index



Cat. No.	Description	Page No.
7020-040	Key Wrench, 2 per box	25, 26
1375-020	Laminectomy Guard	15
PRO2070	Large AO	14
5071-175	Large Bone Oscillating Abrader	46
5071-132	Large Bone Oscillating Blade	43
5071-140	Large Bone Oscillating Blade	43, 46
5071-141	Large Bone Oscillating Blade	43, 46
5071-142	Large Bone Oscillating Blade	43, 46
5071-143	Large Bone Oscillating Blade	43, 45
5071-145	Large Bone Oscillating Blade	43, 46
5071-166	Large Bone Oscillating Blade	43, 44
5071-174	Large Bone Oscillating Blade	43, 45
5071-177	Large Bone Oscillating Blade	43, 44
5071-178	Large Bone Oscillating Blade	43, 45
5071-186	Large Bone Oscillating Blade	43, 44
5071-187	Large Bone Oscillating Blade	43, 45
5071-188	Large Bone Oscillating Blade	43, 45
5071-550	Large Bone Oscillating Blade	43, 44
5071-551	Large Bone Oscillating Blade	43
5071-552	Large Bone Oscillating Blade	43, 44
5071-553	Large Bone Oscillating Blade	43
5071-554	Large Bone Oscillating Blade	43, 46
5071-555	Large Bone Oscillating Blade	43, 46
5071-556	Large Bone Oscillating Blade	43, 44
5071-557	Large Bone Oscillating Blade	43, 45
5071-560	Large Bone Oscillating Blade	43, 45
5071-572	Large Bone Oscillating Blade	43, 45
PRO5095	Large Bone Tray	24
PRO6001	Large Bone Tray with Battery Holders	24
PRO3010	Large NiCad Battery, 9.6 Volt	6
PRO3115	Large NiMH Sterile Transfer Battery, 9.6 Volt	7
E9363	Laryngeal Blade	59
E9012	Locking Collar for E9010 Drill	18
1375-011	Long Bur Guard	15
7020-019	Long Bur Guard (like Midas S-1) Brown	19, 25, 26
7020-012	Long Bur Guard (like Midas-M/B) Mustard	19, 25, 26
E9011-2	Long Bur Guard for E9010 Drill	18
E9011-9	Long Neuro Guard for E9010 Drill	18
7020-016	Long Revision Extension (like Midas RX) Blue	19, 25, 26
N9150	Lynx® Blade	58
TN130-089-90	M-Class® Blade	29
TN130-100-90	M-Class Blade	29
TN130-107-90	M-Class Blade	29
TN130-119-90	M-Class Blade	29
TN130-127-90	M-Class Blade	29
TN130-137-90	M-Class Blade	29
TN130-147-90	M-Class Blade	29
TN190-089-90	M-Class Blade	29
TN190-100-90	M-Class Blade	29
TN190-107-90	M-Class Blade	29
TN190-119-05	M-Class Blade	29
TN190-119-90	M-Class Blade	29
TN190-127-05	M-Class Blade	29
TN190-127-90	M-Class Blade	29

<b>Cat. No.</b>	<b>Description</b>	<b>Page No.</b>
TN190-137-05	M-Class <sup>®</sup> Blade	29
TN190-137-90	M-Class Blade	29
TN190-147-90	M-Class Blade	29
TN193-119-90	M-Class Blade	29
TN193-127-90	M-Class Blade	29
TN193-137-90	M-Class Blade	29
TN250-089-90	M-Class Blade	29
TN250-100-90	M-Class Blade	29
TN250-107-90	M-Class Blade	29
TN250-119-90	M-Class Blade	29
TN250-127-90	M-Class Blade	29
TN250-137-90	M-Class Blade	29
TN250-147-90	M-Class Blade	29
1375-012	Medium Bur Guard	15, 25
7020-018	Medium Bur Guard (like Midas B-1) Green	19, 25, 26
E9011-1	Medium Bur Guard for E9010 Drill	18
7020-011	Medium Bur Guard (like Midas-O) Copper	19, 25, 26
E9011-8	Medium Neuro Guard for E9010 Drill	18
7020-015	Medium Revision Extension (like Midas-R) Purple	19, 25, 26
1375-028	Micro 100™ Footswitch	10
5053-009	Micro 100 Medium Speed Drill	17
5053-012	Micro 100 Oscillating Saw	17
5053-010	Micro 100 Reciprocating Saw	17
5053-011	Micro 100 Sagittal Saw	17
5053-022	Micro 100 XL Oscillating Saw	17
5023-101	MicroPower <sup>®</sup> Intra-Oral Oscillating Saw Blade	52
5023-102	MicroPower Intra-Oral Oscillating Saw Blade	52
5023-103	MicroPower Intra-Oral Oscillating Saw Blade	52
5023-104	MicroPower Intra-Oral Oscillating Saw Blade	52
8703	MicroPower & Micro 100 ACL Sagittal Saw Blade	50
5023-182	MicroPower & Micro 100 ACL Sagittal Saw Blade	50
5023-183	MicroPower & Micro 100 ACL Sagittal Saw Blade	50
5023-184	MicroPower & Micro 100 ACL Sagittal Saw Blade	50
5023-185	MicroPower & Micro 100 ACL Sagittal Saw Blade	50
5023-186	MicroPower & Micro 100 ACL Sagittal Saw Blade	50
C8803	MicroPower & Micro 100 ACL Sagittal Saw Blade	50
C8804	MicroPower & Micro 100 ACL Sagittal Saw Blade	50
C8806	MicroPower & Micro 100 ACL Sagittal Saw Blade	50
5023-167	MicroPower & Micro 100 Angled Oscillating Saw Blade	52
5023-168	MicroPower & Micro 100 Angled Oscillating Saw Blade	52
5023-258	MicroPower & Micro 100 Angled Oscillating Saw Blade	52
5023-259	MicroPower & Micro 100 Angled Oscillating Saw Blade	52
5023-128	MicroPower & Micro 100 Angled Sagittal Saw Blade	50
5023-129	MicroPower & Micro 100 Angled Sagittal Saw Blade	50
5023-134	MicroPower & Micro 100 Angled Sagittal Saw Blade	50
5023-135	MicroPower & Micro 100 Angled Sagittal Saw Blade	50
5023-136	MicroPower & Micro 100 Angled Sagittal Saw Blade	50
5091-252	MicroPower & Micro 100 Barrel Small Bone Bur	55
5091-254	MicroPower <sup>R</sup> & Micro 100 Barrel Small Bone Bur	55
5092-252	MicroPower & Micro 100 Barrel Small Bone Bur	55
5092-254	MicroPower & Micro 100 Barrel Small Bone Bur	55
L45C	MicroPower & Micro 100 Cone Small Bone Bur	56
M45C	MicroPower & Micro 100 Cone Small Bone Bur	56
5023-170	MicroPower & Micro 100 Crescentic Oscillating Saw Blade	52

# Alphabetical Index



Cat. No.	Description	Page No.
5023-171	MicroPower® & Micro 100™ Crescentic Oscillating Saw Blade	52
5023-172	MicroPower & Micro 100 Crescentic Oscillating Saw Blade	52
5023-176	MicroPower & Micro 100 Crescentic Oscillating Saw Blade	52
5092-291	MicroPower & Micro 100 Cylindrical Small Bone Bur	56
5053-050	MicroPower & Micro 100 Depth Limiting Reciprocating Saw Blade	53
5053-051	MicroPower & Micro 100 Depth Limiting Reciprocating Saw Blade	53
5053-052	MicroPower & Micro 100 Depth Limiting Reciprocating Saw Blade	53
5053-053	MicroPower & Micro 100 Depth Limiting Reciprocating Saw Blade	53
5023-055	MicroPower & Micro 100 Dermabrader Sagittal Saw Blade	51
5023-056	MicroPower & Micro 100 Dermabrader Sagittal Saw Blade	51
5023-057	MicroPower & Micro 100 Dermabrader Sagittal Saw Blade	51
5091-080	MicroPower & Micro 100 Dermabraders – Fine Diamond Small Bone Bur	54
5091-081	MicroPower & Micro 100 Dermabraders – Fine Diamond Small Bone Bur	54
5091-082	MicroPower & Micro 100 Dermabraders – Fine Diamond Small Bone Bur	54
5091-083	MicroPower & Micro 100 Dermabraders – Fine Diamond Small Bone Bur	54
5091-270	MicroPower & Micro 100 Dermabraders – Fine Diamond Small Bone Bur	54
5092-270	MicroPower & Micro 100 Dermabraders – Fine Diamond Small Bone Bur	54
5091-260	MicroPower & Micro 100 Fine Round Diamond Small Bone Bur	54
5091-264	MicroPower & Micro 100 Fine Round Diamond Small Bone Bur	54
5091-268	MicroPower & Micro 100 Fine Round Diamond Small Bone Bur	54
5092-260	MicroPower & Micro 100 Fine Round Diamond Small Bone Bur	54
5092-262	MicroPower & Micro 100 Fine Round Diamond Small Bone Bur	54
5092-264	MicroPower & Micro 100 Fine Round Diamond Small Bone Bur	54
5092-266	MicroPower & Micro 100 Fine Round Diamond Small Bone Bur	54
5092-268	MicroPower & Micro 100 Fine Round Diamond Small Bone Bur	54
5093-260	MicroPower & Micro 100 Fine Round Diamond Small Bone Bur	54
5093-262	MicroPower & Micro 100 Fine Round Diamond Small Bone Bur	54
5093-264	MicroPower & Micro 100 Fine Round Diamond Small Bone Bur	54
5093-266	MicroPower & Micro 100 Fine Round Diamond Small Bone Bur	54
L10D	MicroPower & Micro 100 Fine Round Diamond Small Bone Bur	54
M60D	MicroPower & Micro 100 Fine Round Diamond Small Bone Bur	54
X10D	MicroPower & Micro 100 Fine Round Diamond Small Bone Bur	54
5023-405	MicroPower & Micro 100 Graft Harvesting Sagittal Saw Blade	51
5023-406	MicroPower & Micro 100 Graft Harvesting Sagittal Saw Blade	51
5023-407	MicroPower & Micro 100 Graft Harvesting Sagittal Saw Blade	51
5023-408	MicroPower & Micro 100 Graft Harvesting Sagittal Saw Blade	51
5023-409	MicroPower & Micro 100 Graft Harvesting Sagittal Saw Blade	51
5023-410	MicroPower & Micro 100 Graft Harvesting Sagittal Saw Blade	51
5023-411	MicroPower & Micro 100 Graft Harvesting Sagittal Saw Blade	51
5023-412	MicroPower & Micro 100 Graft Harvesting Sagittal Saw Blade	51
5023-413	MicroPower & Micro 100 Graft Harvesting Sagittal Saw Blade	51
5092-283	MicroPower & Micro 100 Heavy Grit Diamond-Microbur. X-Long Small Bone Bur	56
5092-284	MicroPower & Micro 100 Heavy Grit Diamond-Microbur. X-Long Small Bone Bur	56
5092-285	MicroPower & Micro 100 Heavy Grit Diamond-Microbur. X-Long Small Bone Bur	56
5092-286	MicroPower & Micro 100 Heavy Grit Diamond-Microbur. X-Long Small Bone Bur	56
5093-282	MicroPower & Micro 100 Heavy Grit Diamond-Microbur. X-Long Small Bone Bur	56
5093-283	MicroPower & Micro 100 Heavy Grit Diamond-Microbur. X-Long Small Bone Bur	56
5093-284	MicroPower & Micro 100 Heavy Grit Diamond-Microbur. X-Long Small Bone Bur	56
5093-285	MicroPower & Micro 100 Heavy Grit Diamond-Microbur. X-Long Small Bone Bur	56
5091-212	MicroPower & Micro 100 Lindemann Small Bone Bur	56
5023-160	MicroPower & Micro 100 Oscillating Saw Blade	52
5023-161	MicroPower & Micro 100 Oscillating Saw Blade	52
5023-162	MicroPower & Micro 100 Oscillating Saw Blade	52
5023-163	MicroPower & Micro 100 Oscillating Saw Blade	52

<b>Cat. No.</b>	<b>Description</b>	<b>Page No.</b>
5023-164	MicroPower™ & Micro 100™ Oscillating Saw Blade	52
5023-165	MicroPower & Micro 100 Oscillating Saw Blade	52
5023-166	MicroPower & Micro 100 Oscillating Saw Blade	52
5023-169	MicroPower & Micro 100 Oscillating Saw Blade	52
5091-236	MicroPower & Micro 100 Oval Small Bone Bur	55
5091-238	MicroPower & Micro 100 Oval Small Bone Bur	55
5092-238	MicroPower & Micro 100 Oval Small Bone Bur	55
5093-236	MicroPower & Micro 100 Oval Small Bone Bur	55
5093-238	MicroPower & Micro 100 Oval Small Bone Bur	55
L40B	MicroPower & Micro 100 Oval Small Bone Bur	55
L55B	MicroPower & Micro 100 Oval Small Bone Bur	55
M40B	MicroPower & Micro 100 Oval Small Bone Bur	55
M55B	MicroPower & Micro 100 Oval Small Bone Bur	55
X40B	MicroPower & Micro 100 Oval Small Bone Bur	55
X55B	MicroPower & Micro 100 Oval Small Bone Bur	55
5053-080	MicroPower & Micro 100 Reciprocating Rasp	53
5053-081	MicroPower & Micro 100 Reciprocating Rasp	53
5053-082	MicroPower & Micro 100 Reciprocating Rasp	53
5053-083	MicroPower & Micro 100 Reciprocating Rasp	53
5053-084	MicroPower & Micro 100 Reciprocating Rasp	53
5053-085	MicroPower & Micro 100 Reciprocating Rasp	53
5053-054	MicroPower & Micro 100 Reciprocating Saw Blade	53
5053-122	MicroPower & Micro 100 Reciprocating Saw Blade	53
5053-126	MicroPower & Micro 100 Reciprocating Saw Blade	53
5053-220	MicroPower & Micro 100 Reciprocating Saw Blade	53
5053-221	MicroPower & Micro 100 Reciprocating Saw Blade	53
5091-221	MicroPower & Micro 100 Round Fluted Small Bone Bur	54
5091-222	MicroPower & Micro 100 Round Fluted Small Bone Bur	54
5091-223	MicroPower & Micro 100 Round Fluted Small Bone Bur	54
5091-224	MicroPower & Micro 100 Round Fluted Small Bone Bur	54
5091-225	MicroPower & Micro 100 Round Fluted Small Bone Bur	54
5091-226	MicroPower & Micro 100 Round Fluted Small Bone Bur	54
5091-228	MicroPower & Micro 100 Round Fluted Small Bone Bur	54
5091-230	MicroPower & Micro 100 Round Fluted Small Bone Bur	54
5091-232	MicroPower & Micro 100 Round Fluted Small Bone Bur	54
5092-220	MicroPower & Micro 100 Round Fluted Small Bone Bur	54
5092-222	MicroPower & Micro 100 Round Fluted Small Bone Bur	54
5092-224	MicroPower & Micro 100 Round Fluted Small Bone Bur	54
5092-226	MicroPower & Micro 100 Round Fluted Small Bone Bur	54
5092-228	MicroPower & Micro 100 Round Fluted Small Bone Bur	54
5092-230	MicroPower & Micro 100 Round Fluted Small Bone Bur	54
5092-232	MicroPower & Micro 100 Round Fluted Small Bone Bur	54
5092-236	MicroPower & Micro 100 Round Fluted Small Bone Bur	54, 55
5093-220	MicroPower & Micro 100 Round Fluted Small Bone Bur	54
5093-221	MicroPower & Micro 100 Round Fluted Small Bone Bur	54
5093-224	MicroPower & Micro 100 Round Fluted Small Bone Bur	54
5093-226	MicroPower & Micro 100 Round Fluted Small Bone Bur	54
5093-228	MicroPower & Micro 100 Round Fluted Small Bone Bur	54
5093-230	MicroPower & Micro 100 Round Fluted Small Bone Bur	54
5093-232	MicroPower & Micro 100 Round Fluted Small Bone Bur	54
L18R	MicroPower & Micro 100 Round Fluted Small Bone Bur	54
L23R	MicroPower & Micro 100 Round Fluted Small Bone Bur	54
L60R	MicroPower & Micro 100 Round Fluted Small Bone Bur	54
M60R	MicroPower & Micro 100 Round Fluted Small Bone Bur	54



# Alphabetical Index



Cat. No.	Description	Page No.
X60R	MicroPower® & Micro 100™ Round Fluted Small Bone Bur	54
5023-118	MicroPower & Micro 100 Sagittal Saw Blade	49
5023-130	MicroPower & Micro 100 Sagittal Saw Blade	49
5023-131	MicroPower & Micro 100 Sagittal Saw Blade	49
5023-132	MicroPower & Micro 100 Sagittal Saw Blade	49
5023-133	MicroPower & Micro 100 Sagittal Saw Blade	49
5023-137	MicroPower & Micro 100 Sagittal Saw Blade	49
5023-138	MicroPower & Micro 100 Sagittal Saw Blade	49
5023-139	MicroPower & Micro 100 Sagittal Saw Blade	49
5023-140	MicroPower & Micro 100 Sagittal Saw Blade	49
5023-141	MicroPower & Micro 100 Sagittal Saw Blade	49
5023-142	MicroPower & Micro 100 Sagittal Saw Blade	49
5023-143	MicroPower & Micro 100 Sagittal Saw Blade	49
5023-144	MicroPower & Micro 100 Sagittal Saw Blade	49
5023-244	MicroPower & Micro 100 Sagittal Saw Blade	49
5023-247	MicroPower & Micro 100 Sagittal Saw Blade	49
5023-249	MicroPower & Micro 100 Sagittal Saw Blade	49
5044-145	MicroPower & Micro 100 Sagittal Saw Blade	49
5091-242	MicroPower & Micro 100 Swanson Reamer Small Bone Bur	54
5091-243	MicroPower & Micro 100 Swanson Reamer Small Bone Bur	54
5091-244	MicroPower & Micro 100 Swanson Reamer Small Bone Bur	54
5091-245	MicroPower & Micro 100 Swanson Reamer Small Bone Bur	54
5091-213	MicroPower & Micro 100 Tapered Cross-cut Fissure Small Bone Bur	56
5091-271	MicroPower & Micro 100 Tapered Cross-cut Fissure Small Bone Bur	56
5091-272	MicroPower & Micro 100 Tapered Cross-cut Fissure Small Bone Bur	56
5092-271	MicroPower & Micro 100 Tapered Cross-cut Fissure Small Bone Bur	56
5092-272	MicroPower & Micro 100 Tapered Cross-cut Fissure Small Bone Bur	56
5092-273	MicroPower & Micro 100 Tapered Cross-cut Fissure Small Bone Bur	56
5091-206	MicroPower & Micro 100 Tapered Side-cutting Small Bone Bur	55
5091-214	MicroPower & Micro 100 Tapered Side-cutting Small Bone Bur	55
5091-215	MicroPower & Micro 100 Tapered Side-cutting Small Bone Bur	55
5091-218	MicroPower & Micro 100 Tapered Side-cutting Small Bone Bur	55
5091-219	MicroPower & Micro 100 Tapered Side-cutting Small Bone Bur	55
5092-206	MicroPower & Micro 100 Tapered Side-cutting Small Bone Bur	55
5092-214	MicroPower & Micro 100 Tapered Side-cutting Small Bone Bur	55
L12T	MicroPower & Micro 100 Tapered Side-cutting Small Bone Bur	55
L20T	MicroPower & Micro 100 Tapered Side-cutting Small Bone Bur	55
M12T	MicroPower & Micro 100 Tapered Side-cutting Small Bone Bur	55
M20T	MicroPower & Micro 100 Tapered Side-cutting Small Bone Bur	55
5089-208	MicroPower & Micro 100 Straight Side – Cutting Small Bone Bur	55
5091-201	MicroPower & Micro 100 Straight Side – Cutting Small Bone Bur	55
5091-202	MicroPower & Micro 100 Straight Side – Cutting Small Bone Bur	55
5091-204	MicroPower & Micro 100 Straight Side – Cutting Small Bone Bur	55
5091-216	MicroPower & Micro 100 Straight Side – Cutting Small Bone Bur	55
5091-217	MicroPower & Micro 100 Straight Side – Cutting Small Bone Bur	55
5092-203	MicroPower & Micro 100 Straight Side – Cutting Small Bone Bur	55
5092-204	MicroPower & Micro 100 Straight Side – Cutting Small Bone Bur	55
L13S	MicroPower & Micro 100 Straight Side – Cutting Small Bone Bur	55
L17S	MicroPower & Micro 100 Straight Side – Cutting Small Bone Bur	55
M10S	MicroPower & Micro 100 Straight Side – Cutting Small Bone Bur	55
M13S	MicroPower & Micro 100 Straight Side – Cutting Small Bone Bur	55
M15S	MicroPower & Micro 100 Straight Side – Cutting Small Bone Bur	55
M17S	MicroPower & Micro 100 Straight Side – Cutting Small Bone Bur	55
5090-247	MicroPower & Micro 100 Wire Pass Small Bone Bur	54

Cat. No.	Description	Page No.
5090-248	MicroPower™ & Micro 100™ Wire Pass Small Bone Bur	54
5090-249	MicroPower & Micro 100 Wire Pass Small Bone Bur	54
5091-247	MicroPower & Micro 100 Wire Pass Small Bone Bur	54
5091-248	MicroPower & Micro 100 Wire Pass Small Bone Bur	54
5091-249	MicroPower & Micro 100 Wire Pass Small Bone Bur	54
5092-247	MicroPower & Micro 100 Wire Pass Small Bone Bur	54
6021-021	MicroPower Medium Speed Drill Permanently Attached Lever	16
6020-021	MicroPower Medium Speed Drill Removable Lever	16
6021-026	MicroPower Orthopedic High Speed Drill Permanently Attached Lever	16
6020-026	MicroPower Orthopedic High Speed Drill Removable Lever	16
6021-024	MicroPower Oscillating Saw Permanently Attached Lever	16
6020-024	MicroPower Oscillating Saw Removable Lever	16
6021-023	MicroPower Reciprocating Saw Permanently Attached Lever	16
6020-023	MicroPower Reciprocating Saw Removable Lever	16
6021-022	MicroPower Sagittal Saw Permanently Attached Lever	16
6020-022	MicroPower Sagittal Saw Removable Lever	16
N9330	MicroXcisor™ Blade	58
PR02039	Mini AO	14
PR06202M	Mpower™ 2 2-Trigger Modular Handpiece	11
PR06350M	Mpower 2 Oscillating Saw	11
PR06400M	Mpower 2 Reciprocating Saw	11
PR06200M	Mpower 2 Single Trigger Modular Handpiece	11
PR06450M	MPOWER 2 Battery Sternum Saw	21
PR07020	Multipurpose High Speed	14
6021-025	Oral Max™ High Speed Drill Permanently Attached Lever	16
6020-025	Oral Max High Speed Drill Removable Lever	16
5056-080	Osteon™ 80 Grit Dermabrasion Bur	69
5056-081	Osteon 80 Grit Dermabrasion Bur	69
5056-082	Osteon 80 Grit Dermabrasion Bur	69
5056-083	Osteon 80 Grit Dermabrasion Bur	69
5038-009	Osteon and Ototom Bur Bur Rack,	20, 27, 28
5056-950	Osteon Coarse Diamond Round Bur	69
5056-952	Osteon Coarse Diamond Round Bur	69
5056-958	Osteon Coarse Diamond Round Bur	69
5056-959	Osteon Coarse Diamond Round Bur	69
5056-962	Osteon Coarse Diamond Round Bur	69
5056-967	Osteon Coarse Diamond Round Bur	69
5056-170	Osteon Deep Access Bur	69
5056-171	Osteon Deep Access Bur	69
5056-172	Osteon Deep Access Bur	69
5056-175	Osteon Deep Access Bur	69
5056-176	Osteon Deep Access Bur	69
5056-147	Osteon Fine Diamond Round Bur	69
5056-148	Osteon Fine Diamond Round Bur	69
5056-150	Osteon Fine Diamond Round Bur	69
5056-152	Osteon Fine Diamond Round Bur	27, 69
5056-158	Osteon Fine Diamond Round Bur	27, 69
5056-159	Osteon Fine Diamond Round Bur	27, 69
5056-160	Osteon Fine Diamond Round Bur	69
5056-161	Osteon Fine Diamond Round Bur	27, 69
5056-162	Osteon Fine Diamond Round Bur	27, 69
5056-163	Osteon Fine Diamond Round Bur	69
5056-167	Osteon Fine Diamond Round Bur	69
5056-168	Osteon™ Fine Diamond Round Bur	69

# Alphabetical Index



Cat. No.	Description	Page No.
5056-116	Osteon™ Fluted Round Bur	69
5056-117	Osteon Fluted Round Bur	27, 69
5056-118	Osteon Fluted Round Bur	27, 69
5056-119	Osteon Fluted Round Bur	69
5056-125	Osteon Fluted Round Bur	69
5056-126	Osteon Fluted Round Bur	27, 69
5056-127	Osteon Fluted Round Bur	69
5056-128	Osteon Fluted Round Bur	69
5056-140	Osteon Fluted Round Bur	27, 69
5056-142	Osteon Fluted Round Bur	27, 69
5056-144	Osteon Fluted Round Bur	69
5056-145	Osteon Fluted Round Bur	27, 69
5056-146	Osteon Fluted Round Bur	27, 69
5056-149	Osteon Fluted Round Bur	69
5056-164	Osteon Fluted Round Bur	27, 69
5056-165	Osteon Fluted Round Bur	69
5056-166	Osteon Fluted Round Bur	27, 69
5056-173	Osteon Fluted Round Bur	69
5056-174	Osteon Fluted Round Bur	69
5056-177	Osteon Fluted Round Bur	69
5056-178	Osteon Fluted Round Bur	69
5056-179	Osteon Fluted Round Bur	69
5038-004	Osteon Footswitch with Hose	20, 27, 28
5038-002	Osteon Handpiece, Angled	20, 27, 28
5038-001	Osteon Handpiece, Straight	20, 27, 28
5038-005	Osteon Hose	20, 27, 28
5038-600	Osteon Tubing Set with irrigation tip	20
5056-184	Osteon Wire Pass Bur	69
5056-185	Osteon Wire Pass Bur	69
5056-186	Osteon Wire Pass Bur	69
5056-109	Osteon/Otome Bur Set, includes 16 burs (see System Listings Page 26)	20
N9390	Otolaryngology Bur	60
PRO6140	Pin Driver for PRO6100 Range: 1.8 – 4.0mm (0.071 – 0.157")	11 - 13
PRO6240	Pin Driver for PRO6202 Range: 1.8 – 4.0mm (0.071 – 0.157")	11
5059-005	Pneumatic Sternum Saw	21
PRO6135	PowerPro Electric II™ Reciprocating Saw	12
PRO6100	PowerPro Electric II Single Trigger Modular Handpiece	12
PRO6125	PowerPro® Oscillating Saw	12
PRO2000	PowerPro Console	8
PRO6175	PowerPro Pneumatic Oscillating Saw	13
PRO6185	PowerPro Pneumatic Reciprocating Saw	13
PRO6150	PowerPro Pneumatic Single Trigger Modular Handpiece	13
T301	Punch Disassembly Tool	23
PRO2514	Radiolucent Drive Adaptor	14
PRO6045	Reciprocating Saw Attachment for PRO6100, PRO6150, PRO6200M, & PRO6202M	14
M208	Regulator, Dual Connection	10
M207	Regulator, Single Connection	10
1384-175	Repeat Sternotomy Blade	71
1384-176	Repeat Sternotomy Blade	71
5023-178	Repeat Sternotomy Blade	71
5023-179	Repeat Sternotomy Blade	71
5023-180	Repeat Sternotomy Blade	71
5023-187	Repeat Sternotomy Blade	71
5023-188	Repeat Sternotomy Blade	71

<b>Cat. No.</b>	<b>Description</b>	<b>Page No.</b>
5059-278	Repeat Sternotomy Blade	71, 72
5059-279	Repeat Sternotomy Blade	71, 72
5059-280	Repeat Sternotomy Blade	71, 72
5071-125	Repeat Sternotomy Blade	71, 72
5071-126	Repeat Sternotomy Blade	71, 72
5071-228	Repeat Sternotomy Blade	71, 72
5071-229	Repeat Sternotomy Blade	71, 72
5071-230	Repeat Sternotomy Blade	71, 72
5057-040	Repeat Sternotomy Saw, Pneumatic	21
1365-005	Replacement Hex Wrench for Micro 100™ Sagittal & Oscillating Saw	17
1375-021	Rhinoplasty Guard	15
N9385	Rhinotec® Spherical Diamond Bur, Hooded	61
A9350	Rhinotec Cuda® Blade	58
C9950	Rhinotec Cuda Blade	58
C9951	Rhinotec Cuda Blade	58
C9952	Rhinotec Cuda Blade	58
E9350	Rhinotec Cuda Blade	58
E9351	Rhinotec Cuda Blade	58
N9210	Rhinotec Cuda Blade	58
A9360	Rhinotec Gator® Blade	59
C9960	Rhinotec Gator Blade	59
C9961	Rhinotec Gator Blade	59
C9962	Rhinotec Gator Blade	59
E9360	Rhinotec Gator Blade	59
E9361	Rhinotec Gator Blade	59
N9220	Rhinotec Gator Blade	59
C9911	Rhinotec Spherical Bur, Hooded	61
C9912	Rhinotec Spherical Bur, Hooded	61
N9380	Rhinotec Spherical Bur, Hooded	61
N9382	Rhinotec Spherical Bur, Unhooded	61
C9990	Rhinotec Vortex® Router	60
C9991	Rhinotec Vortex Router	60
PR02043	Sagittal Saw Attachment	14
5144-002	Schrader Coupler	10
7020-017	Short Bur Guard (like Midas B-5) Black	19, 25, 26
7020-010	Short Bur Guard (like Midas-X) Red	19, 25, 26
E9011-7	Short Neuro Guard for E9010 Drill	18
7020-014	Short Revision Extension (like Midas TU) Teal	19, 25, 26
PR02038	Small AO—Low Profile	14
PR02138	Small AO—One Handed Operation	14
PR06000	Small Bone Tray	24
PR03020	Small NiCad Battery, 12 Volt	6
PR03520	Small NiMH Sterile Transfer Battery, 12 Volt	7
6020-260	Smartguard® Irrigator	17
5020-160	Smartguard	17
5052-144	ST Cebotome Metal Cutting Bur, Side, Flat	28, 70
5052-145	ST Cebotome Metal Cutting Bur, Side, Round	28, 70
5052-049	Standard Bur Extension, Long, use with standard Cebotome Burs	22
5052-048	Standard Bur Extension, Medium, use with standard Cebotome Burs	22, 28
PR02075	Standard Hudson (DePuy)	14
T121	Staple Pry	23
T122	Staple Seater	23
T110	Staplizer® Carrier, 10mm	23
T113	Staplizer Carrier, 13mm	23

# Alphabetical Index



Cat. No.	Description	Page No.
T116	Stapliizer® Carrier, 16mm	23
T107	Stapliizer Carrier, 7mm	23
7007-03	Stapliizer Cartridge	57
7010-03	Stapliizer Cartridge	57
7015-03	Stapliizer Cartridge	57
7307-03	Stapliizer Cartridge	57
7310-03	Stapliizer Cartridge	57
7315-03	Stapliizer Cartridge	57
7320-03	Stapliizer Cartridge	57
7610-03	Stapliizer Cartridge	57
7615-03	Stapliizer Cartridge	57
7620-03	Stapliizer Cartridge	57
7625-03	Stapliizer Cartridge	57
7707-03	Stapliizer Cartridge	57
7710-03	Stapliizer Cartridge	57
T100	Stapliizer Handpiece	23
5052-012	Sterilization Case	20, 24, 25
5059-006	Sternum Guard, 2.25" (5.72mm), for PRO6450, PRO6450M & 5059-005	21
5059-011	Sternum Guard, 3.12" (7.92mm), for PRO6450, PRO6450M & 5059-005	21
5059-031	Sternum Saw Blade	71
5059-031-01	Sternum Saw Blade	71
5059-032-01	Sternum Saw Blade	71
5059-233	Sternum Saw Blade	71
5059-235	Sternum Saw Blade	71
5059-531	Sternum Saw Blade	71
5059-532	Sternum Saw Blade	71
5059-007	Sternum Saw Wrench, for PRO6450, PRO6450M & 5059-005	21
5072-100	Stryker Large Bone Knee Blade	39
5072-101	Stryker Large Bone Knee Blade	41
5072-102	Stryker Large Bone Knee Blade	40
5072-105	Stryker Large Bone Knee Blade	39, 40
5072-109	Stryker Large Bone Knee Blade	39, 40
5072-110	Stryker Large Bone Knee Blade	39, 41
5072-111	Stryker Large Bone Knee Blade	39, 41
5072-140	Stryker Large Bone Knee Blade	39
5072-142	Stryker Large Bone Knee Blade	39, 40
5072-143	Stryker Large Bone Knee Blade	39
5072-145	Stryker Large Bone Knee Blade	39
5072-150	Stryker Large Bone Knee Blade	39
5072-151	Stryker Large Bone Knee Blade	39, 40
5072-152	Stryker Large Bone Knee Blade	39, 40
5072-158	Stryker Large Bone Knee Blade	39, 41
5072-176	Stryker Large Bone Knee Blade	39, 41
5072-177	Stryker Large Bone Knee Blade	39, 41
5072-181	Stryker Large Bone Knee Blade	39, 41
5072-183	Stryker Large Bone Knee Blade	39, 41
5072-185	Stryker Large Bone Knee Blade	39, 41
5072-195	Stryker Large Bone Knee Blade	39, 40
5072-218	Stryker Large Bone Knee Blade	39, 40
5052-135	Stryker Large Bone Reciprocating Blade	48
5052-332	Stryker Large Bone Reciprocating Blade	48
5052-333	Stryker Large Bone Reciprocating Blade	48
5052-334	Stryker Large Bone Reciprocating Blade	48
5058-001	Surgairtome Two High Speed Drill	17, 25

<b>Cat. No.</b>	<b>Description</b>	<b>Page No.</b>
5058-000	Surgairtome Two <sup>®</sup> High Speed Drill Kit (System listing on page 24)	17
5053-074	Throttle Clip (for lever) Used during footswitch operation	17
1387-022	Tissue Retractor	15
PRO3130	Transfer Shroud for PRO3110	7
PRO3531	Transfer Shroud for PRO3521	7
7021-094	UltraPower <sup>®</sup> Carbide Metal Cutting Bur	68
7021-294	UltraPower Carbide Metal Cutting Bur	68
7021-297	UltraPower Carbide Metal Cutting Bur	68
7021-074	UltraPower Coarse Round Diamond Bur	65
7021-075	UltraPower Coarse Round Diamond Bur	65
7021-077	UltraPower Coarse Round Diamond Bur	65
7021-171	UltraPower Coarse Round Diamond Bur	65
7021-172	UltraPower Coarse Round Diamond Bur	65
7021-173	UltraPower Coarse Round Diamond Bur	65
7021-174	UltraPower Coarse Round Diamond Bur	65
7021-175	UltraPower Coarse Round Diamond Bur	65
7021-176	UltraPower Coarse Round Diamond Bur	65
7021-177	UltraPower Coarse Round Diamond Bur	65
7021-272	UltraPower Coarse Round Diamond Bur	65
7021-273	UltraPower Coarse Round Diamond Bur	65
7021-274	UltraPower Coarse Round Diamond Bur	65
7021-275	UltraPower Coarse Round Diamond Bur	65
7021-276	UltraPower Coarse Round Diamond Bur	65
7021-277	UltraPower Coarse Round Diamond Bur	65
7021-371	UltraPower Coarse Round Diamond Bur	65
7021-372	UltraPower Coarse Round Diamond Bur	65
7021-373	UltraPower Coarse Round Diamond Bur	65
7021-374	UltraPower Coarse Round Diamond Bur	65
7021-375	UltraPower Coarse Round Diamond Bur	65
7021-376	UltraPower Coarse Round Diamond Bur	65
7021-377	UltraPower Coarse Round Diamond Bur	65
7021-474	UltraPower Coarse Round Diamond Bur	65
7021-279	UltraPower Fine Diamond Cylindrical Bur	67
7021-378	UltraPower Fine Diamond Cylindrical Bur	67
7021-379	UltraPower Fine Diamond Cylindrical Bur	67
7021-092	UltraPower Fine Diamond Wheels for Metal Cutting Bur	68
7021-292	UltraPower Fine Diamond Wheels for Metal Cutting Bur	68
7021-392	UltraPower Fine Diamond Wheels for Metal Cutting Bur	68
7021-492	UltraPower Fine Diamond Wheels for Metal Cutting Bur	68
7021-062	UltraPower Fine Round Diamond Bur	64
7021-063	UltraPower Fine Round Diamond Bur	64
7021-064	UltraPower Fine Round Diamond Bur	64
7021-065	UltraPower Fine Round Diamond Bur	64
7021-066	UltraPower Fine Round Diamond Bur	64
7021-161	UltraPower Fine Round Diamond Bur	64
7021-162	UltraPower Fine Round Diamond Bur	64
7021-163	UltraPower Fine Round Diamond Bur	64
7021-164	UltraPower Fine Round Diamond Bur	64
7021-165	UltraPower Fine Round Diamond Bur	64
7021-166	UltraPower Fine Round Diamond Bur	64
7021-167	UltraPower Fine Round Diamond Bur	64
7021-261	UltraPower Fine Round Diamond Bur	64
7021-262	UltraPower Fine Round Diamond Bur	64
7021-263	UltraPower Fine Round Diamond Bur	64

# Alphabetical Index



<b>Cat. No.</b>	<b>Description</b>	<b>Page No.</b>
7021-264	UltraPower® Fine Round Diamond Bur	64
7021-265	UltraPower Fine Round Diamond Bur	64
7021-266	UltraPower Fine Round Diamond Bur	64
7021-267	UltraPower Fine Round Diamond Bur	64
7021-361	UltraPower Fine Round Diamond Bur	64
7021-362	UltraPower Fine Round Diamond Bur	64
7021-363	UltraPower Fine Round Diamond Bur	64
7021-364	UltraPower Fine Round Diamond Bur	64
7021-365	UltraPower Fine Round Diamond Bur	64
7021-366	UltraPower Fine Round Diamond Bur	64
7021-367	UltraPower Fine Round Diamond Bur	64
7021-081	UltraPower Fluted Acorn Bur	67
7021-083	UltraPower Fluted Acorn Bur	67
7021-181	UltraPower Fluted Acorn Bur	67
7021-182	UltraPower Fluted Acorn Bur	67
7021-183	UltraPower Fluted Acorn Bur	67
7021-280	UltraPower Fluted Acorn Bur	67
7021-281	UltraPower Fluted Acorn Bur	67
7021-282	UltraPower Fluted Acorn Bur	67
7021-283	UltraPower Fluted Acorn Bur	67
7021-380	UltraPower Fluted Acorn Bur	67
7021-381	UltraPower Fluted Acorn Bur	67
7021-382	UltraPower Fluted Acorn Bur	67
7021-383	UltraPower Fluted Acorn Bur	67
7021-482	UltraPower Fluted Acorn Bur	67
7021-483	UltraPower Fluted Acorn Bur	67
7021-581	UltraPower Fluted Acorn Bur	67
7021-583	UltraPower Fluted Acorn Bur	67
7021-681	UltraPower Fluted Acorn Bur	67
7021-683	UltraPower Fluted Acorn Bur	67
7021-036	UltraPower Fluted Cylindrical Bur	66
7021-037	UltraPower Fluted Cylindrical Bur	66
7021-136	UltraPower Fluted Cylindrical Bur	66
7021-137	UltraPower Fluted Cylindrical Bur	66
7021-235	UltraPower Fluted Cylindrical Bur	66
7021-236	UltraPower Fluted Cylindrical Bur	66
7021-237	UltraPower Fluted Cylindrical Bur	66
7021-335	UltraPower Fluted Cylindrical Bur	66
7021-336	UltraPower Fluted Cylindrical Bur	66
7021-337	UltraPower Fluted Cylindrical Bur	66
7021-338	UltraPower Fluted Cylindrical Bur	66
7021-437	UltraPower Fluted Cylindrical Bur	66
7021-391	UltraPower Fluted Frustrum Bur	68
7020-045	Ultrapower Footswitch	19, 25, 26
7020-001	UltraPower High Speed Drill	19, 25, 26
7020-002	UltraPower Low Speed Drill	19, 25, 26
7021-095	UltraPower Oval Fluted Bur	68
7021-096	UltraPower Oval Fluted Bur	68
7021-195	UltraPower Oval Fluted Bur	68
7021-196	UltraPower Oval Fluted Bur	68
7021-295	UltraPower Oval Fluted Bur	68
7021-296	UltraPower Oval Fluted Bur	68
7021-395	UltraPower Oval Fluted Bur	68
7021-396	UltraPower Oval Fluted Bur	68

<b>Cat. No.</b>	<b>Description</b>	<b>Page No.</b>
7020-003	UltraPower® Perforator Drive	19, 25, 26
7021-024	UltraPower Round Fluted Bur	64
7021-025	UltraPower Round Fluted Bur	64
7021-026	UltraPower Round Fluted Bur	64
7021-027	UltraPower Round Fluted Bur	64
7021-028	UltraPower Round Fluted Bur	64
7021-029	UltraPower Round Fluted Bur	64
7021-030	UltraPower Round Fluted Bur	64
7021-031	UltraPower Round Fluted Bur	64
7021-032	UltraPower Round Fluted Bur	64
7021-033	UltraPower Round Fluted Bur	64
7021-034	UltraPower Round Fluted Bur	64
7021-122	UltraPower Round Fluted Bur	64
7021-123	UltraPower Round Fluted Bur	64
7021-124	UltraPower Round Fluted Bur	64
7021-125	UltraPower Round Fluted Bur	64
7021-126	UltraPower Round Fluted Bur	64
7021-127	UltraPower Round Fluted Bur	64
7021-128	UltraPower Round Fluted Bur	64
7021-129	UltraPower Round Fluted Bur	64
7021-130	UltraPower Round Fluted Bur	64
7021-131	UltraPower Round Fluted Bur	64
7021-132	UltraPower Round Fluted Bur	64
7021-133	UltraPower Round Fluted Bur	64
7021-134	UltraPower Round Fluted Bur	64
7021-220	UltraPower Round Fluted Bur	64
7021-222	UltraPower Round Fluted Bur	64
7021-223	UltraPower Round Fluted Bur	64
7021-224	UltraPower Round Fluted Bur	64
7021-225	UltraPower Round Fluted Bur	64
7021-226	UltraPower Round Fluted Bur	64
7021-227	UltraPower Round Fluted Bur	64
7021-228	UltraPower Round Fluted Bur	64
7021-229	UltraPower Round Fluted Bur	64
7021-230	UltraPower Round Fluted Bur	64
7021-231	UltraPower Round Fluted Bur	64
7021-232	UltraPower Round Fluted Bur	64
7021-233	UltraPower Round Fluted Bur	64
7021-322	UltraPower Round Fluted Bur	64
7021-323	UltraPower Round Fluted Bur	64
7021-324	UltraPower Round Fluted Bur	64
7021-325	UltraPower Round Fluted Bur	64
7021-326	UltraPower Round Fluted Bur	64
7021-327	UltraPower Round Fluted Bur	64
7021-328	UltraPower Round Fluted Bur	64
7021-329	UltraPower Round Fluted Bur	64
7021-331	UltraPower Round Fluted Bur	64
7021-332	UltraPower Round Fluted Bur	64
7021-333	UltraPower Round Fluted Bur	64
7021-426	UltraPower Round Fluted Bur	64
7021-427	UltraPower Round Fluted Bur	64, 65
7021-428	UltraPower Round Fluted Bur	64
7021-429	UltraPower Round Fluted Bur	64
7021-431	UltraPower Round Fluted Bur	64



# Alphabetical Index



<b>Cat. No.</b>	<b>Description</b>	<b>Page No.</b>
7021-432	UltraPower® Round Fluted Bur	64
7021-433	UltraPower Round Fluted Bur	64
7021-526	UltraPower Round Fluted Bur	64
7021-528	UltraPower Round Fluted Bur	64
7021-529	UltraPower Round Fluted Bur	64
7021-531	UltraPower Round Fluted Bur	64
7021-532	UltraPower Round Fluted Bur	64
7021-533	UltraPower Round Fluted Bur	64
7021-631	UltraPower Round Fluted Bur	64
7021-632	UltraPower Round Fluted Bur	64
7021-633	UltraPower Round Fluted Bur	64
7021-012	UltraPower Side Cutting Bur	66
7021-013	UltraPower Side Cutting Bur	66
7021-015	UltraPower Side Cutting Bur	66
7021-043	UltraPower Side Cutting Bur	66
7021-112	UltraPower Side Cutting Bur	66
7021-113	UltraPower Side Cutting Bur	66
7021-114	UltraPower Side Cutting Bur	66
7021-115	UltraPower Side Cutting Bur	66
7021-116	UltraPower Side Cutting Bur	66
7021-119	UltraPower Side Cutting Bur	66
7021-143	UltraPower Side Cutting Bur	66
7021-202	UltraPower Side Cutting Bur	65
7021-206	UltraPower Side Cutting Bur	65
7021-207	UltraPower Side Cutting Bur	65
7021-210	UltraPower Side Cutting Bur	65
7021-214	UltraPower Side Cutting Bur	66
7021-218	UltraPower Side Cutting Bur	66
7021-243	UltraPower Side Cutting Bur	66
7021-301	UltraPower Side Cutting Bur	66
7021-302	UltraPower Side Cutting Bur	65
7021-303	UltraPower Side Cutting Bur	65
7021-305	UltraPower Side Cutting Bur	65
7021-309	UltraPower Side Cutting Bur	65
7021-310	UltraPower Side Cutting Bur	65
7021-314	UltraPower Side Cutting Bur	66
7021-315	UltraPower Side Cutting Bur	66
7021-318	UltraPower Side Cutting Bur	66
7021-408	UltraPower Side Cutting Bur	65
7021-409	UltraPower Side Cutting Bur	65
7021-509	UltraPower Side Cutting Bur	65
7021-051	UltraPower Trefhine Bur	67
7021-250	UltraPower Trefhine Bur	67
7021-252	UltraPower Trefhine Bur	67
7021-253	UltraPower Trefhine Bur	67
7021-255	UltraPower Trefhine Bur	67
7021-040	UltraPower Wire Pass Bur	67, 68
7021-041	UltraPower Wire Pass Bur	67, 68
7021-042	UltraPower Wire Pass Bur	67, 68
7021-140	UltraPower Wire Pass Bur	67, 68
7021-141	UltraPower Wire Pass Bur	67, 68
7021-142	UltraPower Wire Pass Bur	67, 68
7021-141-35	UltraPower Wire Pass Burs – Depth Limiting Bur	67, 68
7021-141-50	UltraPower Wire Pass Burs – Depth Limiting Bur	67, 68

<b>Cat. No.</b>	<b>Description</b>	<b>Page No.</b>
7021-141-90	UltraPower® Wire Pass Burs – Depth Limiting Bur	67, 68
7021-145-70	UltraPower Wire Pass Burs – Depth Limiting Bur	67, 68
5052-010	Universal Hose, 10' (3.05m) for Hall® Handpieces	10, 22, 25, 26, 28
T123	Width Guage	23
5053-013	Wire Driver	17
5053-019	Wire Driver Adapter Chuck for use with 5053-013	17
PRO6128	Wire Driver for PRO6100 Range: 0.7 – 1.6mm (0.028 – 0.062")	11 - 13
PRO6228	Wire Driver for PRO6202 Range: 0.7 – 1.6mm (0.028 – 0.062")	11
5053-123	Wire Guard for use with 5053-013	17
PRO3011	X-Large NiCad Battery, 12 Volt	6
1375-023	X-Long Bur Guard	15
7020-013	X-Long Bur Guard (ike Midas-AM/A) Lime	19, 25, 26
E9011-3	X-Long Bur Guard for E9010 Drill	18
1375-040	Y Connector	10
PRO2046	Zimmer/Hudson	14









Hall® Powered  
Instruments System™  
Product Catalog

525 French Road  
Utica, New York 13502

Local 727-392-6464  
Toll Free 1-800-237-0169

ConMed.com  
customer\_service@conmed.com

**HALL®**  
POWERED INSTRUMENTS