

POWERED INSTRUMENTS

Product Catalog

HALL®



CONMED
LINVATEC

Ordering Information.....	2
Product Support.....	3
Product Support and Service Programs.....	4
Return/Repair Information.....	5
Batteries and Accessories.....	6
Electric Consoles and Accessories.....	7
Pneumatic Regulators, Hoses and Accessories.....	8
MPower® 2 Indications for Use: Large Bone and Small Bone Orthopedics.....	9
PowerPro® Max Indications for Use: Large Bone Orthopedics.....	10
PowerPro and PowerPro Electric II™ Indications for Use: Large Bone and Small Bone Orthopedics.....	11
PowerPro Pneumatic Indications for Use: Large Bone and Small Bone Orthopedics.....	12
MPower 2, MPower, PowerPro Max, PowerPro Electric II and PowerPro Pneumatic Attachments.....	13
MicroPower® and Micro100™ Attachments and Bur Guards.....	14
MicroPower Indications for Use: Small Bone.....	15
Micro100 Indications for Use: Small Bone.....	16
E9000® System Indications for Use: ENT, Spine and Neuro.....	17
Ultrapower® Indications for Use: Spine and Neuro.....	18
Osteon Indications for use: ENT.....	19
Sternum Saws.....	20
Cebotome® Indications for use: Large Bone Revision Surgery.....	21
Staplizer®.....	22
Small Bone Fixation System.....	22
Miscellaneous Accessories.....	23
Kit Listings.....	24 – 27
Intrex™ Blade Systems.....	28
Large Bone Knee Blades Indication for Use: Total Knee Arthroplasty.....	29 – 38
Large Bone Oscillating Blades.....	39
ACL Blades.....	39
Large Bone Oscillating Blades Indications for Use: Total Hip Arthroplasty and Large Bone Trauma.....	40 – 43
Large Bone Reciprocating Blades Indications for Use: Total Joint Arthroplasty and Large Bone Trauma.....	44, 45
MicroPower and Micro100 Sagittal Saw Blades Indications for Use: Small Bone.....	46 – 48
MicroPower and Micro100 Oscillating Saw Blades Indications for Use: Small Bone.....	49
MicroPower and Micro100 Reciprocating Saw Blades and Rasps Indications for Use: Small Bone.....	50
MicroPower and Micro100 Small Bone Burs Indications for Use: Small Bone.....	51 – 53
Wires and Staples Indication for Use: Small Bone Trauma.....	54
E9005 ENT Shaver Blades Indications for Use: Sinus Surgery.....	55 – 58
E Burs Indications for Use: Otology, Spine and Neuro.....	59, 60
UltraPower Burs Indications for Use: Otology (Round Burs Only), Spine and Neuro.....	61 – 65
Osteon Burs Indications for use: Otology.....	66
Cebotome Burs and Metal Cutting Accessories Indication for Use: Large Bone Revisions Surgery.....	67
Sternum Saw Blades Indication for Use: Primary and Repeat Sternotomy.....	68, 69
Numerical Index.....	71 – 88
Alphabetical Index.....	89 – 106

All products may not be available in all markets.

Terms

ConMed Linatec standard terms are net thirty (30) days, F.O.B. shipping point, unless otherwise approved in writing by ConMed Linatec. All orders and transactions are subject to the laws of the state of Florida.

To Place Your Order

Please provide a purchase order number, billing and shipping instructions, product catalog number and description, valid ConMed Linatec quotation, and quantity and pricing to one of the following:

Your Sales Representative

Customer Service

Phone: 800-237-0169

Fax: 727-399-5256

E-mail: custserv1@linatec.com

ConMed Linatec

Attn: Customer Service

11311 Concept Boulevard

Largo, FL 33773-4908 USA

True Purchasing Flexibility

ConMed Linatec Financial Services offers a variety of flexible financing programs from leases to Pre-Procedure Programs to delayed payment plans. Ask your Sales Representative for more information on how you can acquire the latest technology through a financing program that fits your unique budgetary requirements.

Rental Kits

In every O.R. there are times when you have to schedule a case but do not have the equipment needed. Either the capital funding for the equipment has yet to be approved or you have been unable to justify the cost of the equipment due to the procedure's low volume.

For these situations, ConMed Linatec offers a rental program for procedure-specific instruments and powered equipment. One toll free phone call, to ConMed Linatec House Accounts Department at 888-587-9742, and everything that you need for the case is on its way.

To enroll in a rental program contact your Sales Representative or call ConMed Linatec Customer Service directly. Your representative will help you customize the kit(s) to fit your procedural requirements. After the case, simply return the instruments cleaned and sterilized, if appropriate, along with any disposables you did not use. You will be billed only for the rental fee and for the disposables not returned.

At ConMed Linvatec, we want to offer more than a quality product. We take pride in being able to provide you with value added services to support our products. The information given in this catalog is designed to address your questions regarding product support.

Customer Support

If you encounter a problem or need technical assistance, contact Customer Service (Product Support) or your Sales Representative. Refer to the Customer Service telephone numbers listed.

Regulatory Compliance

Report any injuries or malfunctions to ConMed Linvatec Customer Service. Refer to the Customer Service telephone numbers listed.

Original Warranty

ConMed Linvatec (the "Company") warrants to the first purchaser or lessee ("You" or "Customer") that the instruments, attachments and parts manufactured by or for the Company (hereinafter collectively "Instruments") have been tested, inspected, and shipped in proper working order.

The Company warrants all new instruments to be free from defects in materials and workmanship for the following periods, measured from date of sale:

Original Warranties

MPower® and MPower 2 Handpieces	24 Months
Powered Surgical Instruments	12 Months
Power Attachments.....	12 Months
All Single Use Products.....	Upon Receipt
Handpiece Cords and Power Cords	6 Months
Pneumatic hoses	6 Months
Bur guards, blade guards, attachments	6 Months
Battery Packs.....	3 Months
Battery Chargers.....	12 Months
Camera Consoles	12 Months
Video Components	12 Months
Video Cables and Light Guides	3 Months
Scopes	12 Months
Camera Heads.....	12 Months
Shutt® Instruments.....	12 Months
Footswitches.....	12 Months
Irrigation Systems (pumps and remotes).....	12 Months
Reusable Procedure Specific Instruments	12 Months

Following the Original Warranty, ConMed Linvatec offers additional warranty and service programs that support our products throughout their

lifetime. Service programs address the necessity to control cost and greatly reduce repair turnaround time by eliminating the need for repair quotes. Products not covered under a service program are subject to variable repair charges. To find out which service option best meets your needs, contact your local Sales Representative.

Service Agreements

Service Agreements provide additional service coverage on capital equipment. This additional warranty period covers all repair costs, periodic maintenance free loaner usage (upon availability) during repair time and freight charges out from ConMed Linvatec both on the loaner product and the repaired instrument. You are responsible for the freight charges in for both the instrument needing repair and the return shipment of the loaner.

Service Warranty

After expiration of the Original or Service Agreement period, instruments may be returned to ConMed Linvatec for repair at the Customer's expense. ConMed Linvatec warrants that any service or repair work performed by ConMed Linvatec shall be free from defects in workmanship and materials for a period of 90 days after the date the Customer receives the Instrument(s). This limited warranty applies only to the actual service or repair work performed by ConMed Linvatec or its authorized service centers. ConMed Linvatec warrants that all parts and assemblies used in the repair or service of Instruments meet new part functional specifications, although some parts or assemblies may have been remanufactured.

ConMed Linvatec components are manufactured to exacting tolerances and design specifications. As a standard practice, all repairs are subject to strict product performance and testing specifications prior to returning the Instrument to the Customer. ConMed Linvatec ensures that each Instrument is inspected according to the guidelines used for new manufactured Instruments. If an Instrument is determined unrepairable, ConMed Linvatec will offer to sell to the Customer a refurbished or brand new Instrument or comparable equivalent at a preferential price. All parts and assemblies replaced by ConMed Linvatec shall become the property of ConMed Linvatec.

Repair Quotes

Upon request Customer Service can estimate the repair charges for non-warranty repairs. If a firm repair quote is requested, please return your product for inspection and you will be contacted before the repair is initiated. If a product is returned and a firm quote is not requested, the repair will be processed and your account billed accordingly.

Minimum Service Charge

There is a minimum repair charge for the evaluation and testing of all returns (except for products covered under warranty).

Return Shipping

All repaired products will be returned to you via second day air delivery unless you request an alternate shipping method. The cost of return shipping is your responsibility unless the product is under warranty or service agreement.

Warranty Terms

If the Customer discovers within the warranty period (Original or Service Agreement) that an Instrument has a defect in materials and/or workmanship, the customer must promptly notify the Company. Also, if the Customer discovers within the service warranty period that any service or repair work performed by ConMed Linvatec has a defect in workmanship and/or materials, the Customer must promptly notify the Company. If it becomes necessary to return the Instrument to the Company, the Customer must (a) acquire a "Service Request" (SR) authorization from the Company Customer Service Department, (b) pack the unit carefully, and (c) return it to the Company.

Within a reasonable time after receipt of the Instrument, the Company will investigate and correct any defect covered by warranty by providing, at its option, one of the following: service or repair of the Instrument, or replacement of the Instrument. All parts and assemblies replaced by ConMed Linvatec shall become the property of ConMed Linvatec. These remedies are the Customer's exclusive remedies under the warranty.

The foregoing limited warranties do not apply to:

- » Instruments that have been tampered with, altered, neglected, or misused,
- » Instruments damaged through use with other than Company authorized accessories, attachments, burs or blades,
- » Instruments not manufactured by or for the Company,
- » Instruments used for purposes other than those for which they were designed and manufactured, including use in any way inconsistent with the instructions and warnings contained in the Company instruction manuals and package inserts, and
- » Instruments that were last serviced, refurbished, reprocessed or reconditioned by a nonauthorized service entity.

THE FOREGOING LIMITED WARRANTIES ARE IN LIEU OF ALL OTHER WARRANTIES, EXPRESS OR IMPLIED, INCLUDING, BUT NOT LIMITED TO, THE IMPLIED WARRANTIES OF MERCHANTABILITY AND FITNESS FOR A PARTICULAR PURPOSE.

In no case shall the Company be liable for any special, incidental, indirect or consequential damages based upon breach of warranty or any other legal theory. Some jurisdictions do not allow limits on warranties, or on remedies, and, in such jurisdictions, the limits in this and the preceding paragraphs may not apply.

The Company reserves the right (a) to make design changes to Instruments at any time without notice to Customer and without incurring any obligation to incorporate those changes into Instruments previously purchased or leased, and (b) to make changes from time to time in the contents of any publication, instruction manual or package insert without any obligation to notify Customers of such revisions or changes, and (c) to change price without notice.

U.S. Procedure for Returns/Repairs

1. All Instruments must be cleaned and sterilized, if appropriate, prior to return of any Instrument to ConMed Linvatec. Instruments contaminated with biohazardous materials will be returned to you at your expense.
2. An authorized Service Request (SR) Number must be obtained prior to returning any Instrument for repair/return.
3. To return a product for repair, contact ConMed Linvatec Customer Service. The following information is needed to process a repair/return:
 - » Catalog Number
 - » Serial/Lot Number
 - » Original Invoice Number
 - » Detailed description of the problem or reason for return
4. The SR number must be displayed on the outside of the box, included with all paperwork, and must be referred to when making an inquiry about the status of a repair/return.
5. ConMed Linvatec maintains various repair centers around the world. When you are issued your SR number, you will be advised of the location where to send your product.

Ship returns only to:

ConMed Linvatec
Attn. Return Goods Department
11155 Concept Boulevard
Largo, FL 33773-4908 USA

Return Terms

If it becomes necessary to return a product after purchase, the product must be returned within 45 days of its ship date. The product must be returned unused, in the original packaging and be restockable. Returns must be shipped prepaid freight. Returns that are not shipped prepaid freight will not be accepted. All product returns, except those attributable to a ConMed Linvatec error, are subject to a restocking fee of 15% of the purchase price or \$25, whichever is greater.

Products Not Eligible for Credit:

- » Sterile products/single use devices returned with the outer packaging seals broken
- » Non-sterile products that have been sterilized and/or placed in the surgical field
- » Products damaged by customer misuse or negligence
- » Altered or customized products
- » Products damaged in return transit due to inadequate packaging
- » Less than full packages – all products must be in original packaging
- » Obsolete products

Packaging

Whenever it is required to return your product, be sure to package it in a protective carton. We recommend that you save the original shipping container for this purpose. In-transit damage is not covered by the warranty; therefore, it is best to always insure shipments.

Batteries and Accessories



	Cat. No.
Battery Charger	PRO3600
Trauma NiCad Battery, 12 Volt	PRO3030
Small NiCad Battery, 12 Volt	PRO3020
Large NiCad Battery, 9.6 Volt	PRO3010
X-large NiCad Battery, 12 Volt	PRO3011
Small NiMH Sterile Transfer Battery, 12 Volt	PRO3520
Large NiMH Sterile Transfer Battery, 9.6 Volt	PRO3115
Battery Case for PRO3520	PRO3521
Battery Case for PRO3115	PRO3110
Transfer Shroud for PRO3521	PRO3531
Transfer Shroud for PRO3110	PRO3130
Charging Platform for PRO3520	PRO3535
Charging Platform for PRO3115	PRO3135

All products may not be available in all markets.

Advantage® Console Cat. No. D3000

E9000® Console E9000

PowerPro® Console PRO2000

2-Pedal Footswitch 5020-053

3-Pedal Footswitch C9863

Handpiece Cord MC5057

AC Power Cord 5039-003

Fluid Bag Support Rod for D3000 & E9000 5040-180

Console Stand 5020-054



5020-054
All products may not be available in all markets.

Pneumatic Regulators, Hoses and Accessories



1375-028



Universal Hose



Extension Hose



Hose for Staplizer



2075-017



M207



M208



M322



5144-002



1375-040

M105A



M317



1365-016



1375-037

Hall® offers nitrogen specific products. Please contact customer service for information.

	Cat. No.
Micro 100™ Footswitch	1375-028
Universal Hose, 10' (3.05m) for Hall Handpieces	5052-010
Universal Hose, 15' (4.57m) for Hall Handpieces	5052-016

Extension Hose, 10' (3.05m), Male Schrader to Female Schrader	5052-018
Extension Hose, 10' (3.05m), Male Diss and Female Schrader	5052-029
Extension Hose, 15' (4.57m), Male Schrader to Female Schrader	5052-030
Extension Hose, 20' (6.10m), Male Schrader to Female Schrader	5052-031
10' (3.05m) Hose for Staplizer Handpiece	A201

Pressure Tester	2075-017
Regulator, Single Connection	M207

Regulator, Dual Connection.....	M208
---------------------------------	------

DISS to Schrader Adapter	M322
Schrader Coupler.....	5144-002

Y Connector	1375-040
Blitz® Instrument Cleaner (Use with Staplizer Handpiece)	M105A

Instrument Lubricant for Staplizer	M317
Hall® Lubricant for Angled Attachments.....	1365-016
Hall Lubricant for Surgical Angled Attachments	1375-037

All products may not be available in all markets.

Attachments Listed on Page 13

	Cat. No.
Single Trigger Modular Handpiece	PRO6200M
2-Trigger Modular Handpiece	PRO6202M

Oscillating Saw	PRO6350M
Reciprocating Saw	PRO6400M

Wire Driver for PRO6200.....	PRO6128
Range: 0.7 – 1.6mm (0.028 – 0.062")	
Pin Driver for PRO6200.....	PRO6140
Range: 1.8 – 4.0mm (0.071 – 0.157")	

Wire Driver for PRO6202.....	PRO6228
Range: 0.7 – 1.6mm (0.028 – 0.062")	
Pin Driver for PRO6202.....	PRO6240
Range: 1.8 – 4.0mm (0.071 – 0.157")	



PRO6200M



PRO6202M



PRO6350M



PRO6400M



PRO6128



PRO6140



PRO6228



PRO6240

All products may not be available in all markets.

PowerPro® Max

Indications for Use:
Large Bone Orthopedics



PRO5100M



PRO5200M

Attachments Listed on Page 13

Cot. No.

Single Trigger Modular Handpiece	PRO5100M
2-Trigger Full Function Modular Handpiece.....	PRO5200M
2-Trigger Standard (not shown)	PRO5250M



PRO5300M



PRO5400M

Oscillating Saw	PRO5300M
Reciprocating Saw	PRO5400M



PRO5128



PRO5132-4

Wire Driver for PRO5100M.....	PRO5128
Range: 0.7 – 1.6mm (0.028 – 0.062")	
Pin Driver for PRO5100M.....	PRO5132-4
Range: 2.0 – 4.0mm (0.078 – 0.157")	



PRO5228



PRO5232-4

Wire Driver for PRO5200M & PRO5250M	PRO5228
Range: 0.7 – 1.6mm (0.028 – 0.062")	
Pin Driver for PRO5200M & PRO5250M	PRO5232-4
Range: 2.0 – 4.0mm (0.078 – 0.157")	

All products may not be available in all markets.

Attachments Listed on Page 13

Single Trigger Modular Handpiece Cat. No. PRO6100

Oscillating Saw PRO6125

Reciprocating Saw PRO6135

Wire Driver for PRO6100 PRO6128
Range: 0.7 – 1.6mm (0.028 – 0.062")

Pin Driver for PRO6100 PRO6140
Range: 1.8 – 4.0mm (0.071 – 0.157")



PRO6100



PRO6125



PRO6135



PRO6128



PRO6140

All products may not be available in all markets.

PowerPro® Pneumatic

Indications for Use: Large Bone
and Small Bone Orthopedics



PRO6128

PRO6140

Attachments Listed on Page 13

Cat. No.

Single Trigger Modular Handpiece PRO6150





























Oscillating Saw PRO6175

Reciprocating Saw PRO6185

Wire Driver for PRO6150 PRO6128
Range: 0.7 – 1.6mm (0.028 – 0.062")

Pin Driver for PRO6150 PRO6140
Range: 1.8 – 4.0mm (0.071 – 0.157")

All products may not be available in all markets.

1:1 Multipurpose Attachments						
						
1/4" (4.0mm) Jacobs Chuck, with Chuck Key Cat. No. PRO2030	1/4" (4.0mm) Replacement Chuck Key Cat. No. 5044-999-53	1/8" (6.35mm) Jacobs Chuck Cat. No. PRO2041	1/8" (6.35mm) Replacement Chuck Key Cat. No. 5044-999-52	1/8" Keyless Chuck Cat. No. PRO6050	1/8" Keyless Chuck Cat. No. PRO2250	
1:1 Quick Connect Drill Attachments						
						
AO/Trinkle Cat. No. PRO2029	Small AO Cat. No. PRO2038	Zimmer/Hudson Cat. No. PRO2046	Large AO Cat. No. PRO2070	Standard Hudson Cat. No. PRO2075	Mini AO Cat. No. PRO2039	
3:1 Reamers						
						
3:1 1/2" High Torque Jacobs Chuck Cat. No. PRO2042	3:1 Zimmer/Hudson Reamer Cat. No. PRO2047	3:1 Hudson Reamer Cat. No. PRO2065	3:1 Large AO Reamer Cat. No. PRO2040	3:1 Aesculap Reamer Cat. No. PRO2060	3:1 DHS Reamer Cat. No. PRO2080	3:1 Trinkle Reamer Cat. No. PRO2329
5:1 Reamers						
						
5:1 1/2" High Torque Jacobs Chuck Cat. No. PRO6042	5:1 Zimmer/Hudson Reamer Cat. No. PRO6047	5:1 Hudson Reamer Cat. No. PRO6048	5:1 Large AO Reamer Cat. No. PRO6040	5:1 Aesculap Reamer Cat. No. PRO6060		
Miscellaneous Attachments						
						
Radiolucent Drive Adaptor Cat. No. PRO2514	High Speed Drill Attachment Cat. No. PRO2033	Sagittal Saw Attachment Cat. No. PRO2043	Multipurpose High Speed Cat. No. PRO7020	Reciprocating Saw Attachment for PRO5100M, PRO5200M, and PRO5250M Cat. No. PRO2045		
				Reciprocating Saw Attachment for PRO6100, PRO6150, PRO6200M, and PRO6202M Cat. No. PRO6045		

All products may not be available in all markets.

MicroPower® and Micro100™ Attachments and Bur Guards

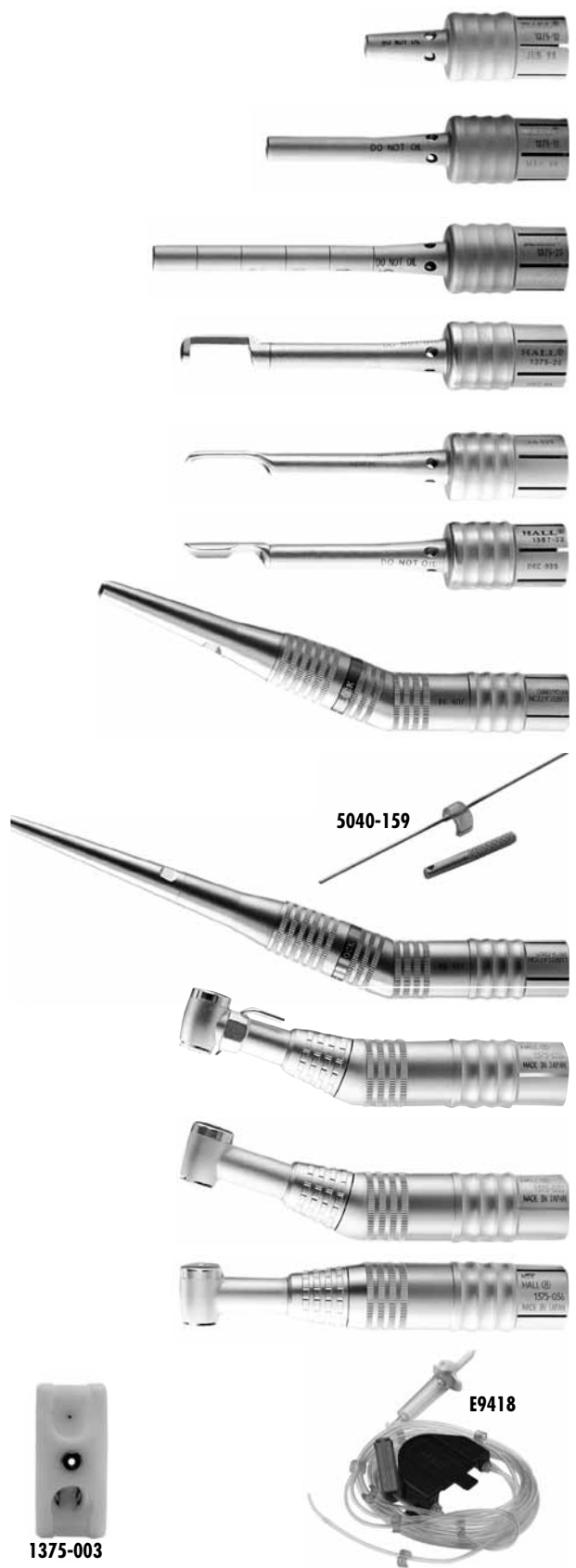

5040-159

E9418

1375-003

Attachments

	Cat. No.
Medium Bur Guard	1375-012
Long Bur Guard	1375-011
X-Long Bur Guard	1375-023
Laminectomy Guard	1375-020
Use 5092-103/203 long carbide burs, the laminectomy burs are the only burs that can be inserted prior to placing bur guard.	
Rhinoplasty Guard	1375-021
Tissue Retractor	1387-022
Use only with long burs (5092 series) which have diameter of 4.0mm or less. Recommended burs 5092-136.	
20 degree Angled Attachment	1375-032
Use only 5092 series X-long burs.	
Reusable 20 degree Angled Bur Tip	5040-158
20 degree X-Long Angled Attachment	1375-033
Use only 5093 series X-long burs.	
Reusable X-Long 20 degree Angled Bur Tip	5040-159
70 degree Contra Angle with Dental Head	1375-034
Use friction grip burs only – size 1/16" or 1.58mm diameter. Not available from ConMed Linvatec.	
70 degree Contra Angle with Surgical Head	1375-035
Use only 5089 ultra-short burs and 5090 series short burs.	
90 degree Angled Attachment	1375-036
Use only 5089 X-short burs and 5090 series short burs.	
Bur Changer for 70 and 90 degree Angled Attachments	1375-003
Irrigation Tubing Set	E9418

All products may not be available in all markets.

Attachments on page 14

Handpieces **Removable Lever** **Permanently Attached Lever**

OralMax High Speed Drill 6020-025..... 6021-025

Orthopedic High Speed Drill 6020-026..... 6021-026

Medium Speed Drill 6020-021..... 6021-021

Sagittal Saw..... 6020-022..... 6021-022

Reciprocating Saw 6020-023..... 6021-023

Oscillating Saw 6020-024..... 6021-024

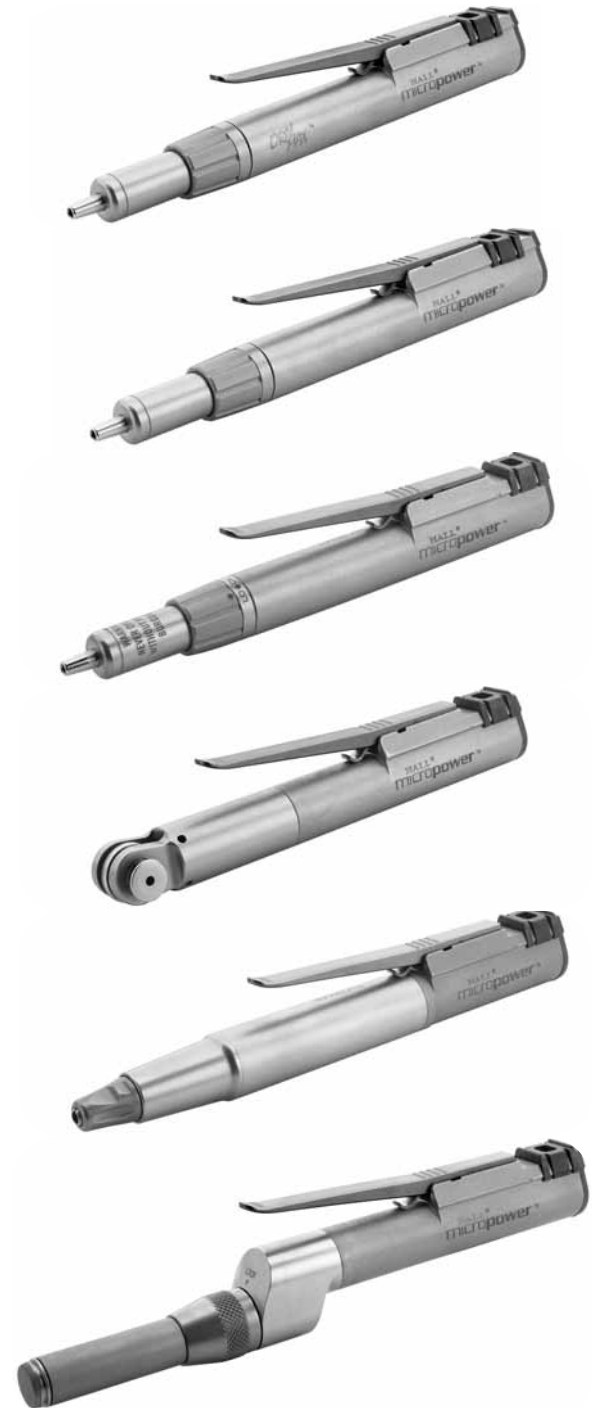

All products may not be available in all markets.

Micro100™

Indications for Use: Small Bone



Attachments on Page 14

Handpieces

	Cat. No.
Surgairtome Two® High Speed Drill Kit (System listing on page 24)	5058-000
Surgairtome Two High Speed Drill	5058-001
Medium Speed Drill	5053-009
Reciprocating Saw	5053-010
Sagittal Saw	5053-011
Oscillating Saw	5053-012
XL Oscillating Saw	5053-022
Wire Driver	5053-013
Throttle Clip (for lever) Used during footswitch operation	5053-074

Attachments and Accessories

Wire Guard for use with 5053-013	5053-123
Wire Driver Adapter Chuck for use with 5053-013	5053-019
Replacement Hex Wrench for Micro100™ Sagittal & Oscillating Saw	1365-005
Burguard Sleeve Surgairtome Two	1375-112
Smartguard®	5020-160
Smartguard® Irrigator	6020-260



All products may not be available in all markets.

Handpieces

CoolFlex® High Speed Drill Cat. No. E9010

High Speed Shaver E9005

Cranial Perforator Drive E9015

Attachments and Accessories

Medium Bur Guard for E9010 Drill E9011-1
 Long Bur Guard for E9010 Drill E9011-2
 X-Long Bur Guard for E9010 Drill E9011-3
 Short Neuro Guard for E9010 Drill E9011-7
 Medium Neuro Guard for E9010 Drill E9011-8
 Long Neuro Guard for E9010 Drill E9011-9

Locking Collar for E9010 Drill E9012

Bur Rack, Holds up to 20 burs for E9010 Drill E9323

Bur Rack, Folding, Holds up to 26 burs for E9010 Drill E9324

Drill Tubing for E9010 Drill without irrigation tip E9414

Drill Tubing for E9010 Drill with irrigation tip E9415A

4.2mm FESS Irrigation Tubing Set for E9005 Shaver E9416

3.7mm FESS Irrigation Tubing Set for E9005 Shaver (Not Shown) E9417

DeClogger for removing tissue and bone from shaver blades and burs E9315

Cleaning Brushes for handpiece cannulations prior to sterilization E9322

Bur Cabinet for Neuro Burs 7020-046

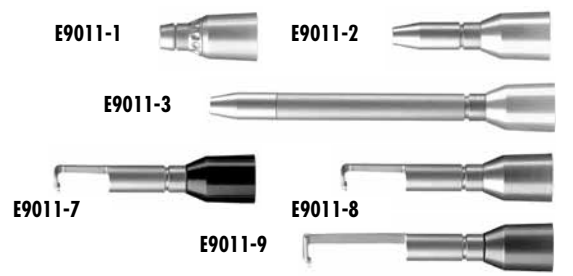
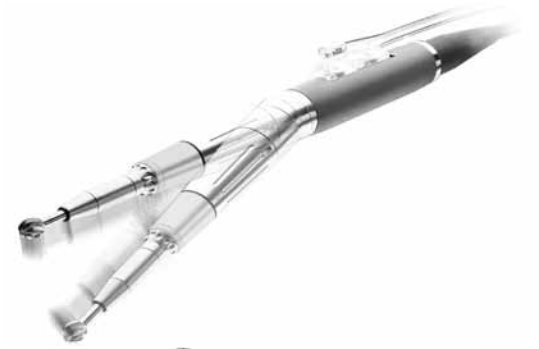

All products may not be available in all markets.



Handpieces

	Cat. No.
High Speed Drill	7020-001
Low Speed Drill	7020-002
Perforator Drive	7020-003

Attachments and Accessories

Ultrapower Footswitch	7020-045
Short Bur Guard (like Midas-X) Red	7020-010
Medium Bur Guard (like Midas-O) Copper	7020-011
Long Bur Guard (like Midas-M/B) Mustard	7020-012
X-Long Bur Guard (like Midas-AM/A) Lime	7020-013
Short Revision Extension (like Midas TU) Teal	7020-014
Medium Revision Extension (like Midas-R) Purple	7020-015
Long Revision Extension (like Midas RX) Blue	7020-016
Short Bur Guard (like Midas B-5) Black	7020-017
Medium Bur Guard (like Midas B-1) Green	7020-018
Long Bur Guard (like Midas S-1) Brown	7020-019
90 degree Angle Attachment (like Midas AF/BF)	7020-022
Uses the 5089 and 5090 Series Burs Only.	
20 degree Long Keyless Attachment	7020-023
Uses the 5092 Series Burs Only.	
20 degree Angle X-Long Keyless Attachment	7020-024
Uses the 5093 Series Burs Only.	



All products may not be available in all markets.

Attachments and Accessories

	Cat. No.
Sterilization Case.....	5052-012
Bur Rack, for Osteon and Ototom Burs.....	5038-009
Osteon/Ototome Bur Set, includes 16 burs (see System Listings Page 26)	5056-109

Handpieces

Osteon Handpiece, Straight.....	5038-001
Osteon Handpiece, Angled.....	5038-002

Attachments and Accessories

Osteon Footswitch with Hose.....	5038-004
Osteon Hose.....	5038-005
Osteon Tubing Set with irrigation tip.....	5038-600



5052-012

5038-009



5038-004



5038-005



5038-600

All products may not be available in all markets.

Sternum Saws



	Cat. No.
MPower® 2 Battery Sternum Saw	PRO6450M
See page six (6) for battery accessories.	
Saw does not include sternum guard or blade.	
Pneumatic Sternum Saw.....	5059-005
Sternum Saw Wrench, for PRO6450, PRO6450M & 5059-005	5059-007
Sternum Guard, 2.25" (5.72mm), for PRO6450, PRO6450M & 5059-005.....	5059-006
Sternum Guard, 3.12" (7.92mm), for PRO6450, PRO6450M & 5059-005.....	5059-011
Repeat Sternotomy Saw, Pneumatic.....	5057-040

All products may not be available in all markets.

Handpieces

	Cat. No.
Cebotome Revision Drill Handpiece	5052-041

Attachments and Accessories

Cebotome Bur Wrench	5052-046
Cebotome Metal Cutting Bur Wrench.....	5052-143
Standard Bur Extension, Short, use with standard Cebotome Burs.....	5052-042
Standard Bur Extension, Medium, use with standard Cebotome Burs	5052-048
Standard Bur Extension, Long, use with standard Cebotome Burs	5052-049
Metal Cutting Bur Extension, use with metal cutting wheels and diamond metal cutting burs	5052-142
Universal Hose, 10' (3.05m).....	5052-010



All products may not be available in all markets.



Handpiece

Cat. No.

Staplizer Handpiece..... T100



Attachments and Accessories

Staplizer Carrier, 7mm..... T107

Staplizer Carrier, 10mm..... T110

Staplizer Carrier, 13mm..... T113

Staplizer Carrier, 16mm..... T116

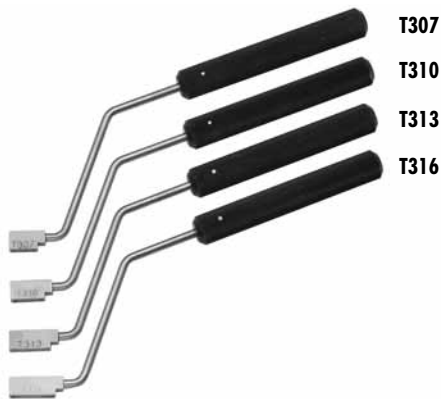

Drill Guide, 7mm..... T307

Drill Guide, 10mm..... T310

Drill Guide, 13mm..... T313

Drill Guide, 16mm..... T316



Staple Pry..... T121



Staple Seater..... T122



T123



T301

Width Gauge..... T123

Punch Disassembly Tool..... T301

Sterilization Case..... T210

Hose, 20' (6.1m)..... A101

Hose, 10' (3.05m)..... A201



T210



A201

All products may not be available in all markets.

Bur Brush Cat. No. 1375-015
 Universal Case E306

Large Case with Dividers 1384-042
 Standard Case 5052-012

Large Bone Tray PRO5095
 Small Bone Tray.....PRO6000

Disposable Filter, 1000/box..... 5037-033

Holding Clamps for use with 5030-010 and 5030-020

Small 5030-028
 Medium 5030-029
 Large Case with Dividers..... 5030-030

Cleaning Brush for Cannulated Handpieces 5053-124

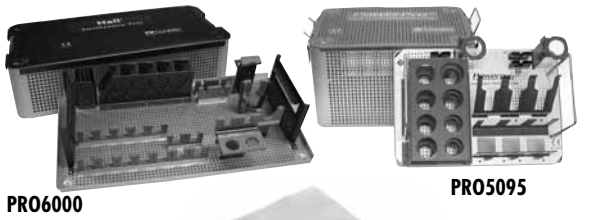
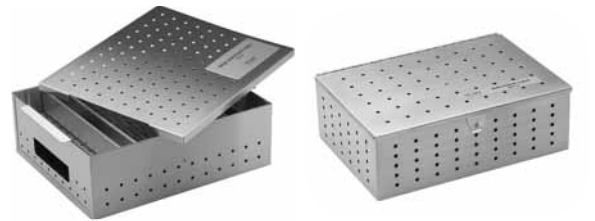
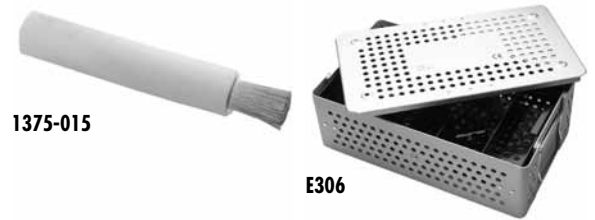

All products may not be available in all markets.



5058-000 Surgairtome Two® System

Components Ordered Separately

	Cat. No.
Surgairtome Two Handpiece	5058-001
Medium Bur Guard	1375-012
Standard Case	5052-012
Universal Hose, 10' (3.05m)	5052-010
Bur Cleaning Brush	1375-015

Ultrapower® Complete Drill System Product Listing

High Speed Drill	7020-001
Low Speed Drill	7020-002
Perforator Drive	7020-003
Universal Hose, 10' (3.05m)	5052-010
Short Bur Guard like Midas-X, Red	7020-010
Medium Bur Guard like Midas-O, Copper	7020-011
Long Bur Guard like Midas-M/B, Mustard	7020-012
X-Long Bur Guard like Midas-AM/A, Lime	7020-013
Short Revision Extension like Midas TU, Teal	7020-014
Medium Revision Extension like Midas-R, Purple	7020-015
Long Revision Extension like Midas RX, Blue	7020-016
Short Bur Guard like Midas B-5, Black	7020-017
Medium Bur Guard like Midas B-1, Green	7020-018
Long Bur Guard like Midas S-1, Brown	7020-019
90 degree Angle Attachment like Midas AF/BF	7020-022
20 degree Long Keyless Attachment	7020-023
20 degree Angle X-Long Keyless Attachment	7020-024
Key Wrench, 2 per box	7020-040
Footswitch	7020-045
Storage Cabinet for Neuro Burs	7020-046
Storage Cabinet for Revision Burs	7020-047
Complete Ultrapower Tray	7020-050
Attachment Spray	7020-041

Ultrapower® Neuro/Spine Drill System Product Listing

Components Ordered Separately

	Cat. No.
High Speed Drill	7020-001
Low Speed Drill	7020-002
Perforator Drive	7020-003
Universal Hose, 10' (3.05m)	5052-010
Short Bur Guard like Midas-X, Red	7020-010
Medium Bur Guard like Midas-O, Copper	7020-011
Long Bur Guard like Midas-M/B, Mustard	7020-012
X-Long Bur Guard like Midas-AM/A, Lime	7020-013
Short Bur Guard like Midas B-5, Black	7020-017
Medium Bur Guard like Midas B-1, Green	7020-018
Long Bur Guard like Midas S-1, Brown	7020-019
90 degree Angle Attachment like Midas AF/BF	7020-022
20 degree Long Keyless Attachment	7020-023
20 degree Angle X-Long Keyless Attachment	7020-024
Key Wrench, 2 per box	7020-040
Footswitch	7020-045
Storage Cabinet for Neuro Burs	7020-046
Neuro/Spine Tray	7020-052
Attachment Spray	7020-041

Ultrapower Basic Drill System Product Listing

Components Ordered Separately

High Speed Drill	7020-001
Universal Hose, 10' (3.05m)	5052-010
Short Bur Guard like Midas-X, Red	7020-010
Medium Bur Guard like Midas-O, Copper	7020-011
Long Bur Guard like Midas-M/B, Mustard	7020-012
X-Long Bur Guard like Midas-AM/A, Lime	7020-013
Short Revision Extension like Midas TU, Teal	7020-014
Medium Revision Extension like Midas-R, Purple	7020-015
Long Revision Extension like Midas RX, Blue	7020-016
Short Bur Guard like Midas B-5, Black	7020-017
Medium Bur Guard like Midas B-1, Green	7020-018
Long Bur Guard like Midas S-1, Brown	7020-019
90 degree Angle Attachment like Midas AF/BF	7020-022
20 degree Long Keyless Attachment	7020-023
20 degree Angle X-Long Keyless Attachment	7020-024
Key Wrench, 2 per box	7020-040
Footswitch	7020-045
Storage Cabinet for Neuro Burs	7020-046
Storage Cabinet for Revision Burs	7020-047
Basic Tray	7020-051
Attachment Spray	7020-041



All products may not be available in all markets.



Osteon/Ototome Burs

Components Ordered Separately

	Cat. No.
Round Carbide Bur, 6.5 x 30 mm, 2 each	5056-117
Round Carbide Bur, 5.0 x 30mm	5056-118
Round Carbide Bur, 4.0 x 30mm	5056-119
Round Carbide Bur, 5.0 x 38mm	5056-126
Round Steel Bur, 1.5 x 48mm	5056-140
Round Steel Bur, 2.0 x 48mm	5056-142
Round Carbide Bur, 4.0 x 48mm	5056-145
Round Carbide Bur, 3.0 x 48mm	5056-146
Round Diamond Bur, 4.0 x 48mm	5056-152
Round Diamond Bur, 1.0 x 48mm	5056-158
Round Diamond Bur, 3.0 x 48mm	5056-159
Round Diamond Bur, 0.5 x 48mm	5056-161
Round Diamond Bur, 2.0 x 48mm	5056-162
Round Steel Bur, 1.0 x 48mm	5056-164
Round Steel Bur, 0.5 x 48mm	5056-166

Osteon Drill System with Burs

Components Ordered Separately

Bur Brush Accessory	1375-015
Osteon Footswitch with Universal Hose 5052-010	5038-004
Osteon Hose	5038-005
Osteon/Ototome Bur Rack	5038-009
Osteon Handpiece, Straight	5038-001
Osteon Handpiece, Angled	5038-002

Osteon Drill System without Bur System

Components Ordered Separately

	Cat. No.
Bur Brush Accessory.....	1375-015
Osteon Footswitch with Universal Hose 5052-010.....	5038-004
Osteon Hose.....	5038-005
Osteon/Ototome Bur Rack.....	5038-009
Osteon Handpiece, Straight.....	5038-001
Osteon Handpiece, Angled.....	5038-002



Revision Drill System

Components Ordered Separately

Universal Hose, 10' (3.05m).....	5052-010
Cebotome Revision Drill Handpiece.....	5052-041
Cebotome Bur Extension, Short.....	5052-042
Cebotome Wrench.....	5052-046
Cebotome Bur Extension, Medium.....	5052-048



Cebotome Metal Cutting Wheel System

Components Ordered Separately

Cebotome Metal Cutting Wheel.....	5052-125
Cebotome Metal Trimming Wheel.....	5052-126
Cebotome Metal Cutting Wheel Wrench.....	5052-129

Cebotome Metal Cutting Bur System

Components Ordered Separately

Cebotome Metal Cutting Bur Extension.....	5052-142
Cebotome Metal Cutting Bur Wrench.....	5052-143
ST Cebotome Metal Cutting Bur, Side, Flat.....	5052-144
ST Cebotome Metal Cutting Bur, Side, Round.....	5052-145



All products may not be available in all markets.

Intrex™ Blade Systems

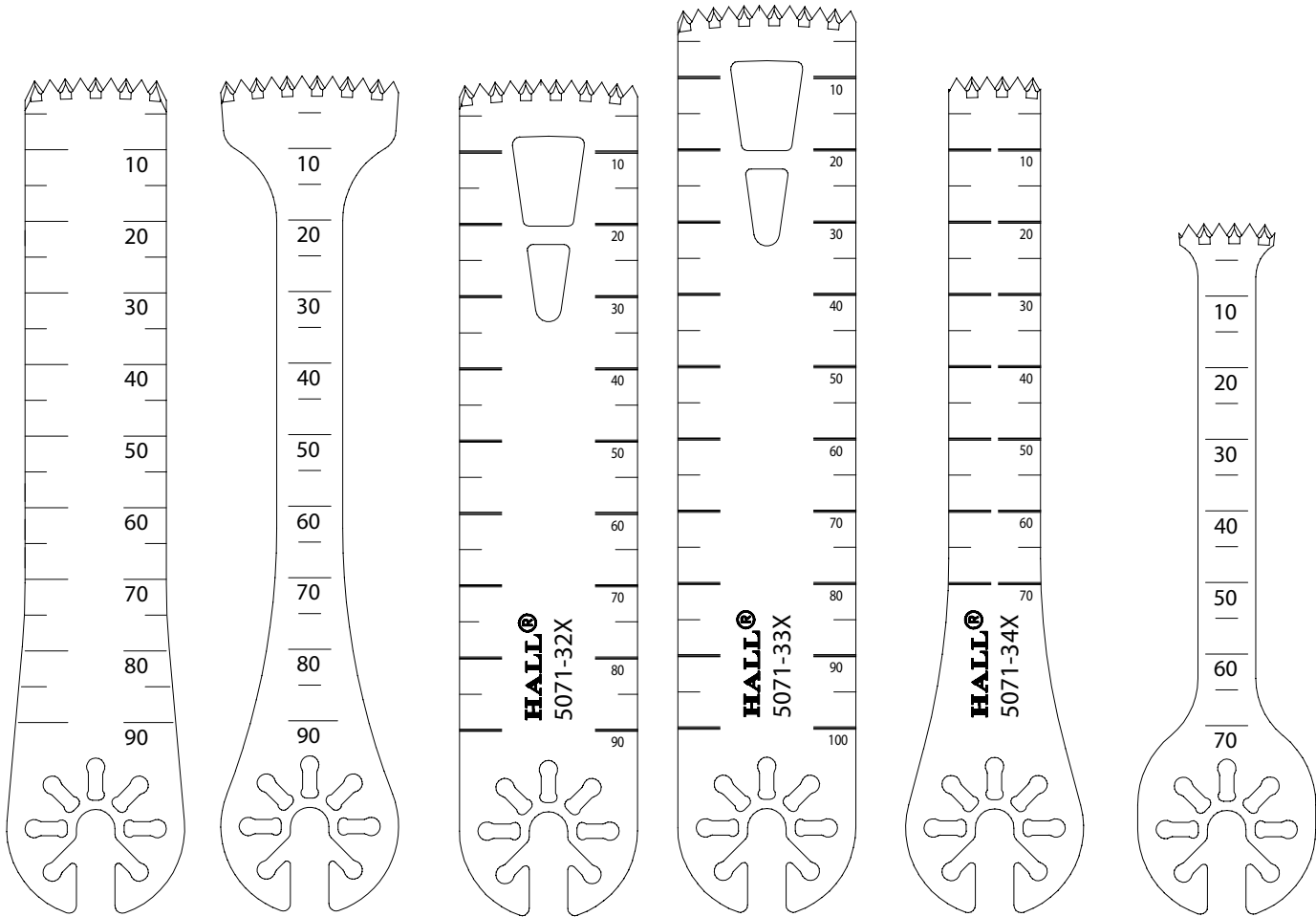

5071-30X

5071-31X

5071-32X

5071-33X

5071-34X

5071-35X

Blades images are 1:1 in length and width.

	Standard	MIS	Standard/ Wide	Standard/Long	Standard/ Narrow	Unicondylar
Head Width	19.5mm	25.0mm	25.0mm	25.0mm	12.5mm	13.0mm
Body Width	19.5mm	9.0mm	25.0mm	25.0mm	12.5mm	8.0mm
Length	90.0mm	90.0mm	90.0mm	100.0mm	90.0mm	70.0mm
Thickness	Blade Catalog #					
0.89mm	5071-300	5071-310	5071-320	5071-330	5071-340	5071-350
1.00mm	5071-301	5071-311	5071-321	5071-331	5071-341	5071-351
1.07mm	5071-302	5071-312	5071-322	5071-332	5071-342	5071-352
1.19mm	5071-303	5071-313	5071-323	5071-333	5071-343	5071-353
1.27mm	5071-304	5071-314	5071-324	5071-334	5071-344	5071-354
1.37mm	5071-305	5071-315	5071-325	5071-335	5071-345	5071-355
1.47mm	5071-306	5071-316	5071-326	5071-336	5071-346	5071-356

All products may not be available in all markets.

Hall® Blades

Cat. No.	Width (mm)	Length (mm)	Material Thickness (mm)	Cut Thickness (mm)	View Illustration
5071-594	29.46	58.70	0.64	0.64	Page 30
5271-502	29.00	74.00	0.64	0.64	Page 30
5071-528	25.00	73.00	0.89	0.89	Page 30
5071-533	21.00	84.50	0.89	0.89	Page 30
5071-583	12.70	90.00	0.89	0.89	Page 30
5071-589	13.00	90.00	0.89	0.89	Page 30
5071-532	12.00	80.00	0.90	0.90	Page 30
5071-185	19.50	80.00	0.90	0.90	Page 30
5071-195	19.50	80.00	0.90	0.90	Page 31
5071-146	25.40	90.00	0.90	0.90	Page 31
5071-196	25.40	90.00	0.90	0.90	Page 31
5071-120	19.50	95.00	0.90	0.90	Page 31
5071-121	25.40	95.00	0.90	0.90	Page 31
5071-562	25.40	90.00	1.00	1.00	Page 31
5071-538	25.40	95.00	1.00	1.00	Page 31
5071-548	12.70	86.00	1.19	1.19	Page 31
5071-547	25.40	86.00	1.19	1.19	Page 32
5071-167	19.50	90.00	1.20	1.20	Page 32
5071-184	19.50	90.00	1.20	1.20	Page 32
5071-558	18.50	73.00	1.24	1.24	Page 32
5071-534	25.40	79.50	1.24	1.24	Page 32
5071-570-50	25.00	95.00	1.24	1.24	Page 32
5071-526	18.50	107.00	1.24	1.24	Page 32
5071-573	18.50	90.00	1.26	1.26	Page 32
5071-575	31.00	90.00	1.26	1.26	Page 33
5071-527	19.00	80.00	1.27	1.27	Page 33
5071-180	10.00	85.00	1.27	1.27	Page 33
5271-580	10.00	85.00	1.27	1.27	Page 33
5071-531	25.40	85.00	1.27	1.27	Page 33
5071-181	19.50	86.00	1.27	1.27	Page 33
5071-201	19.50	86.00	1.27	1.27	Page 33
5071-582	13.00	90.00	1.27	1.27	Page 33
5071-161	25.40	90.00	1.27	1.27	Page 34
5071-564	25.40	90.00	1.27	1.27	Page 34
5271-561	25.40	90.00	1.27	1.27	Page 34
5071-590	13.00	95.00	1.27	1.27	Page 34
5071-568	16.50	95.00	1.27	1.27	Page 34
5071-576	16.50	95.00	1.27	1.27	Page 34
5071-123	19.50	95.00	1.27	1.27	Page 34
5071-519	21.00	95.00	1.27	1.27	Page 34
5071-124	25.40	95.00	1.27	1.27	Page 35
5071-129	19.50	105.00	1.27	1.27	Page 35
5071-529	19.50	105.00	1.27	1.27	Page 35
5071-163	25.40	90.00	1.37	1.37	Page 35
5071-525	19.00	95.00	1.37	1.37	Page 35
5071-530	19.00	95.00	1.37	1.37	Page 35
5071-539	25.40	95.00	1.37	1.37	Page 35
5071-565	25.40	90.00	1.47	1.47	Page 35
5071-144	25.40	90.00	1.50	1.50	Page 35

All products may not be available in all markets.

Large Bone Knee Blades

Indication for Use: Total Knee Arthroplasty



5071-594

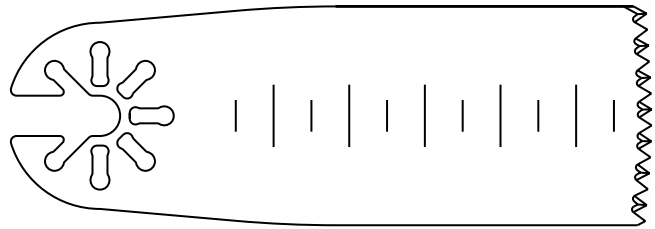

5271-502

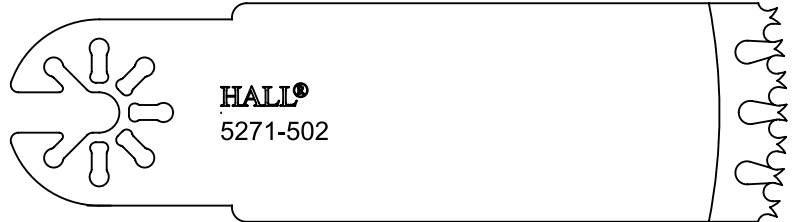

5071-528

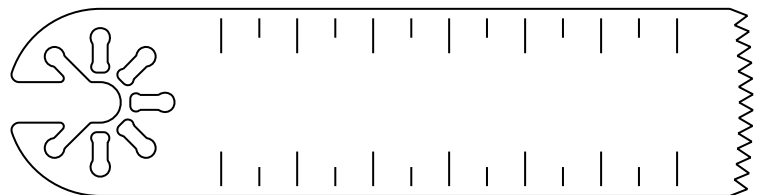

5071-533

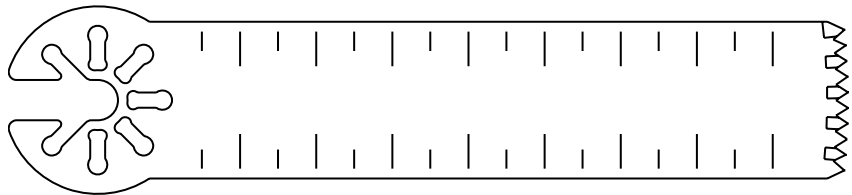

5071-583

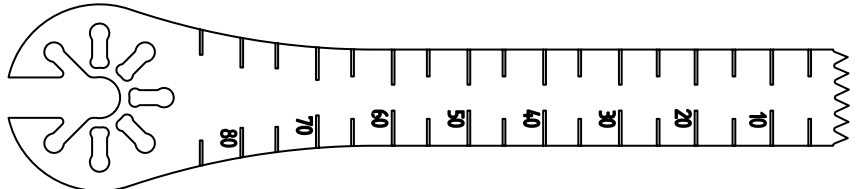

5071-589

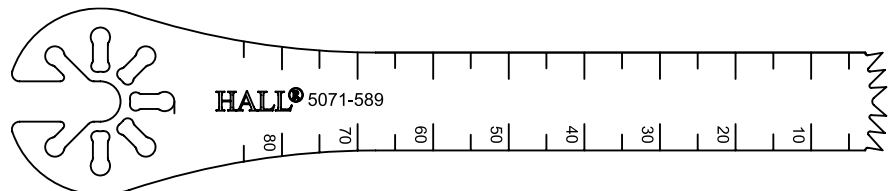

5071-532

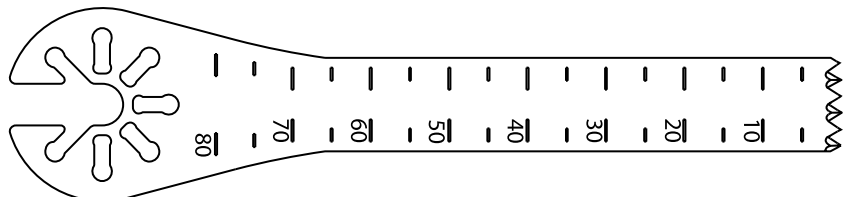

5071-185

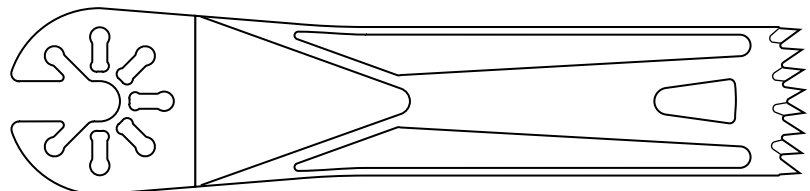

Products shown at actual size.

All products may not be available in all markets.

Large Bone Knee Blades

Indication for Use: Total Knee Arthroplasty

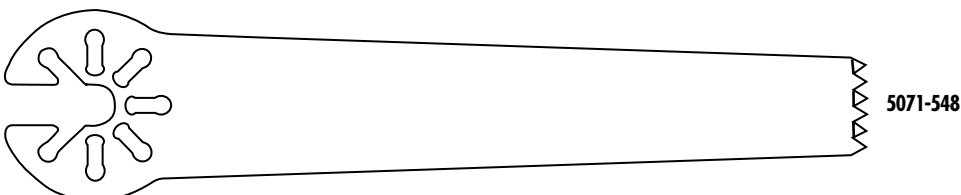
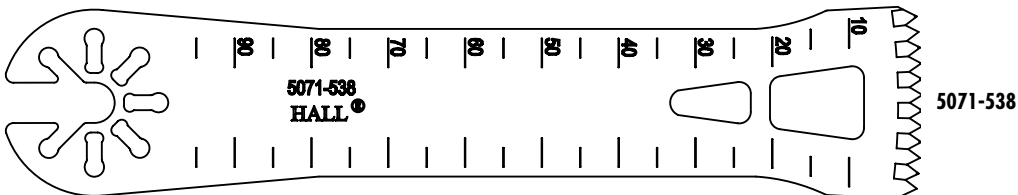
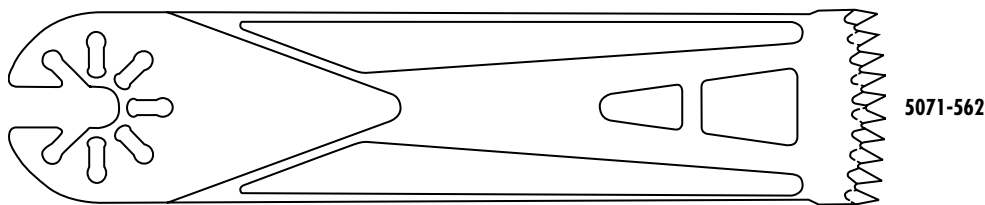
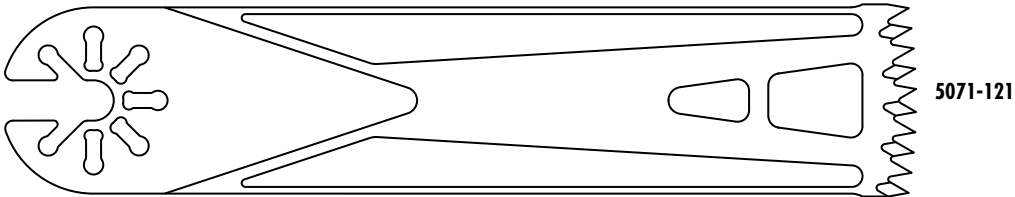
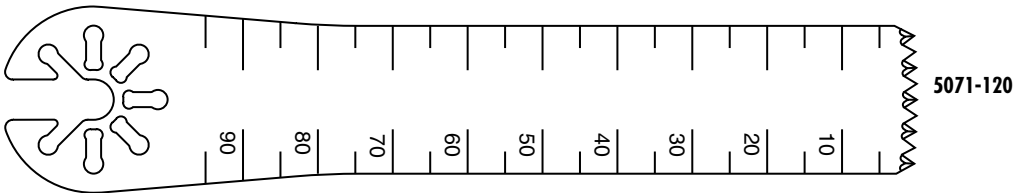
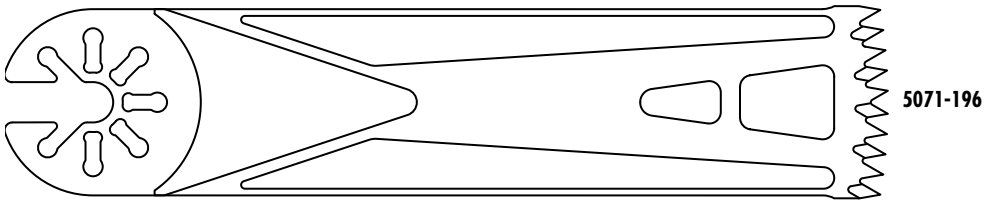
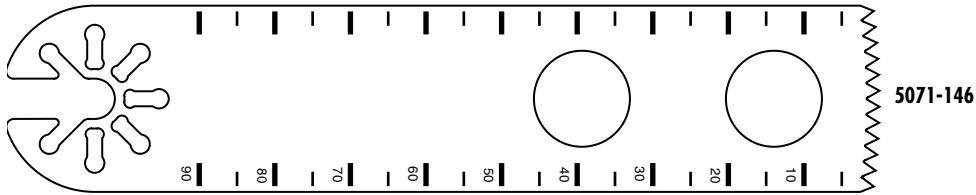
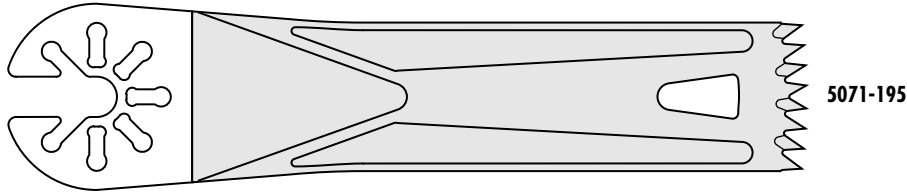

Shaded blades indicate coating
Products shown at actual size.

All products may not be available in all markets.

Large Bone Knee Blades

Indication for Use: Total Knee Arthroplasty

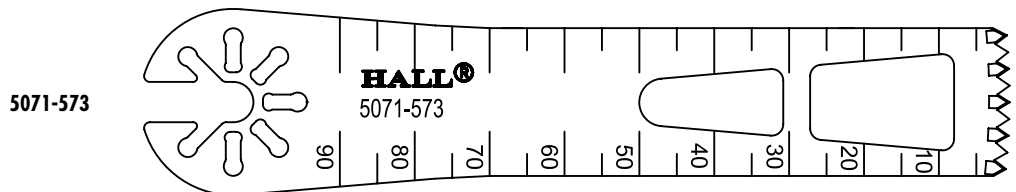
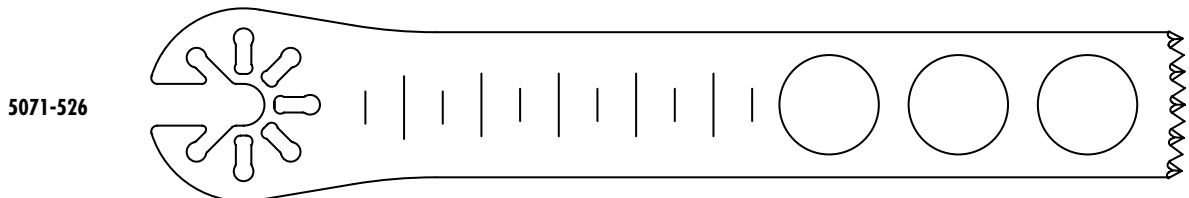
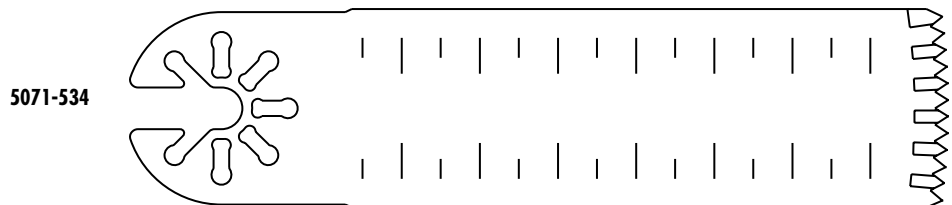
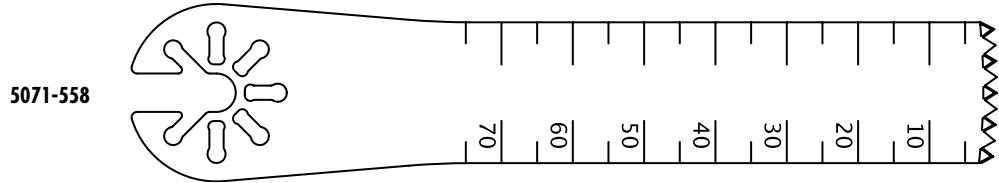
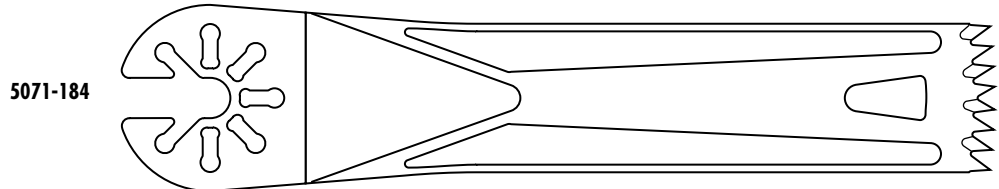
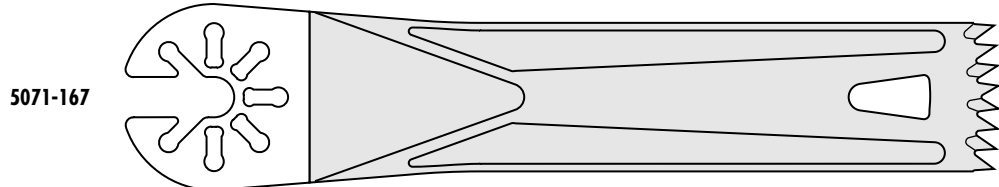
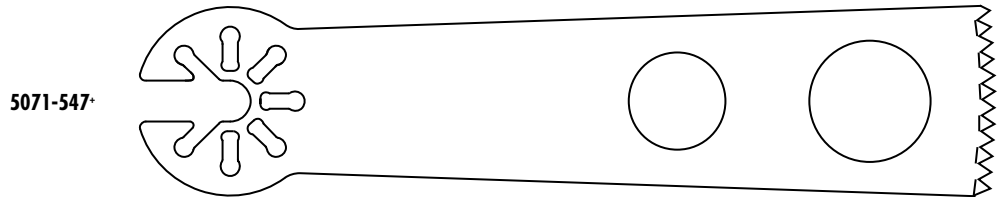

Shaded blades indicate coating
Products shown at actual size.

All products may not be available in all markets.

Large Bone Knee Blades

Indication for Use: Total Knee Arthroplasty

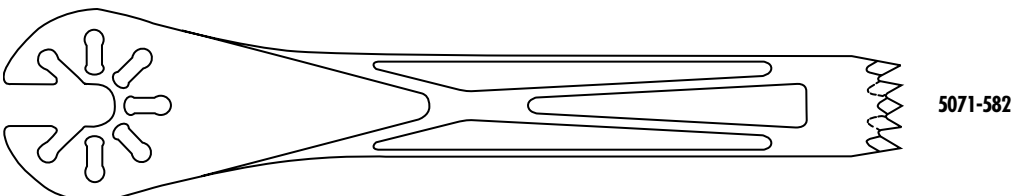
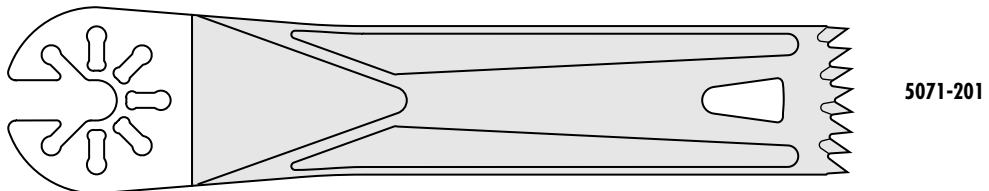
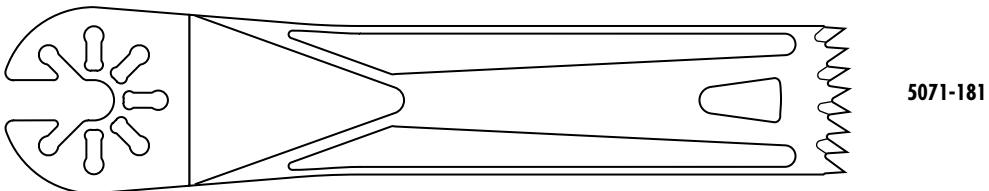
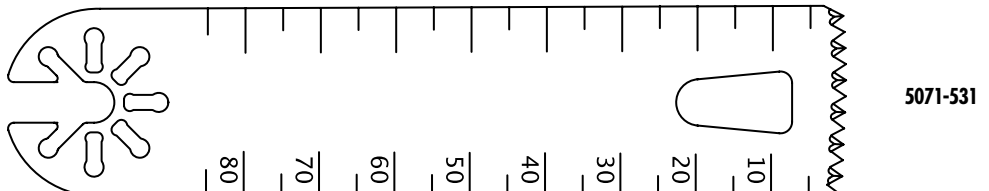
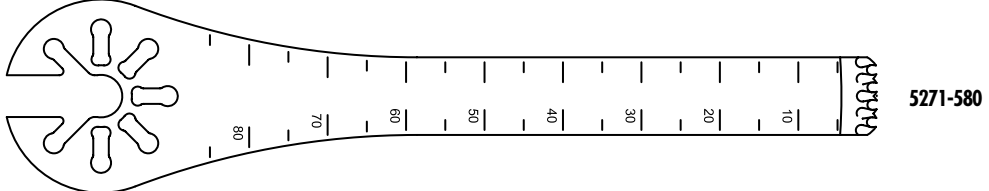
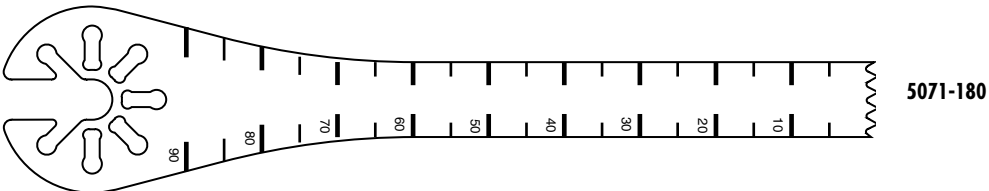
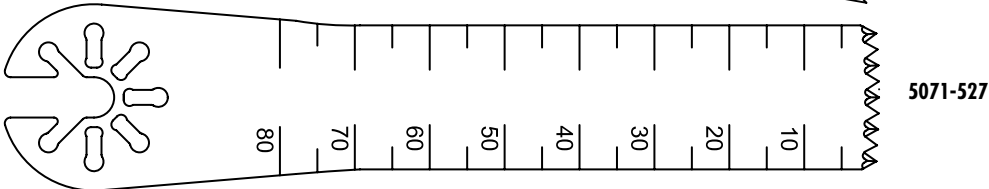
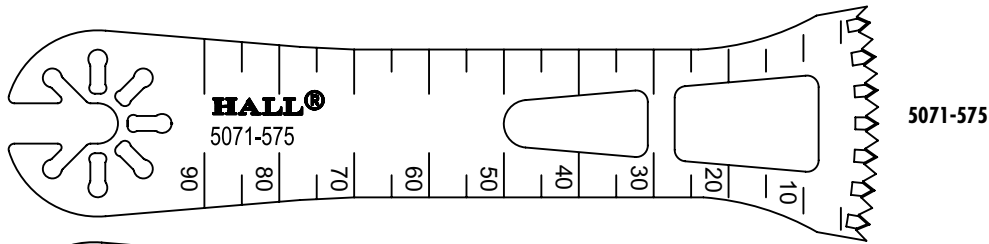

Shaded blades indicate coating
Products shown at actual size.
All products may not be available in all markets.

Large Bone Knee Blades

Indication for Use: Total Knee Arthroplasty



5071-161

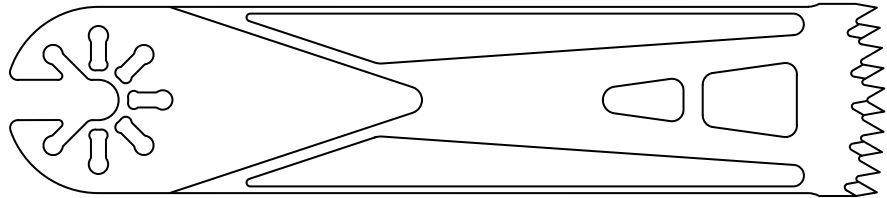

5071-564

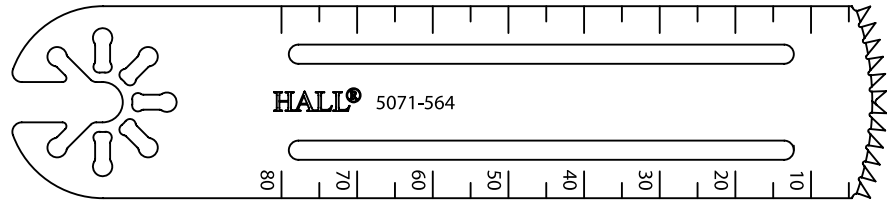

5271-561

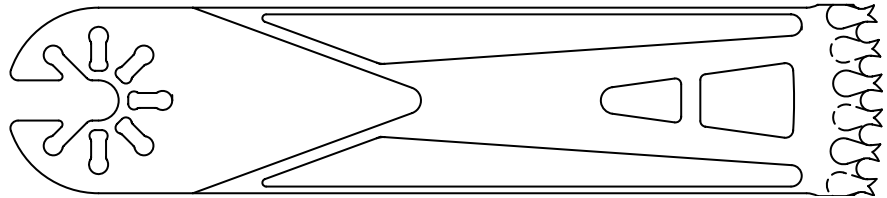

5071-590

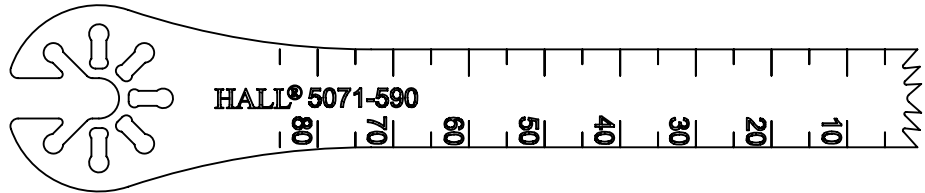

5071-568



5071-576

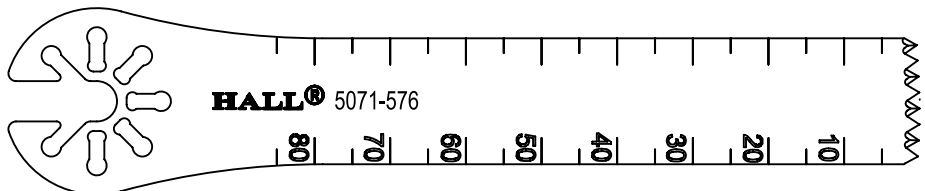

5071-123

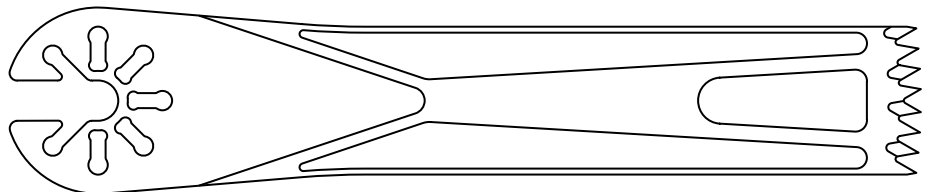

5071-519



Products shown at actual size.

All products may not be available in all markets.

Large Bone Knee Blades

Indication for Use: Total Knee Arthroplasty

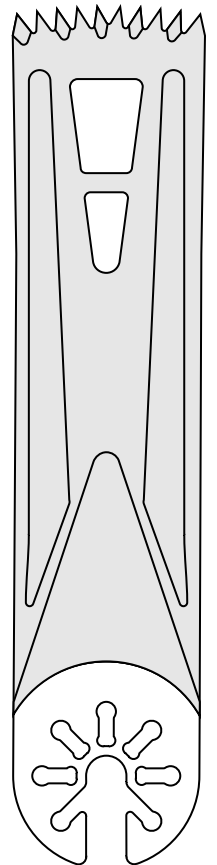
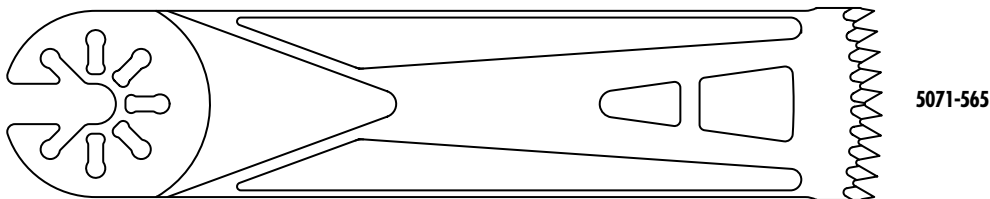
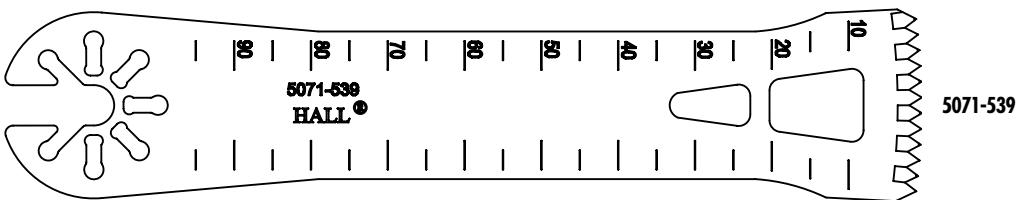
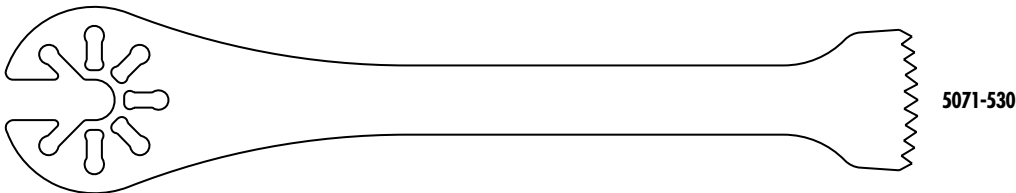
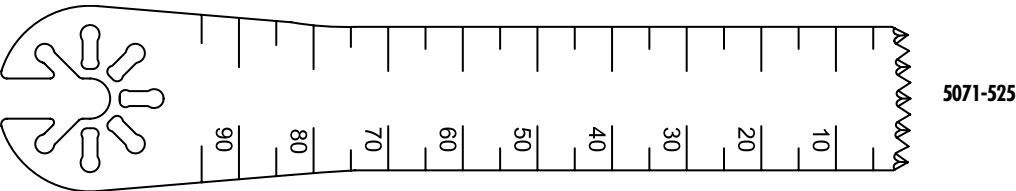
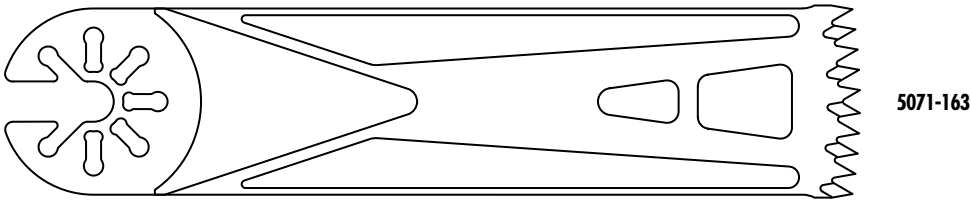
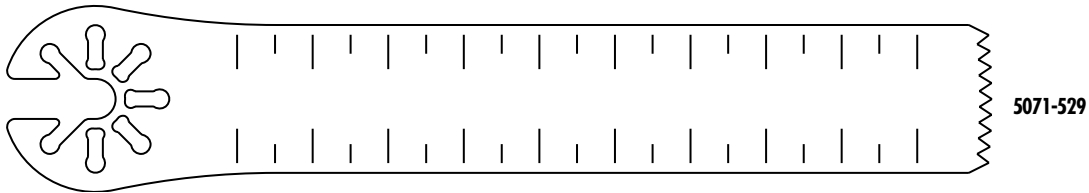
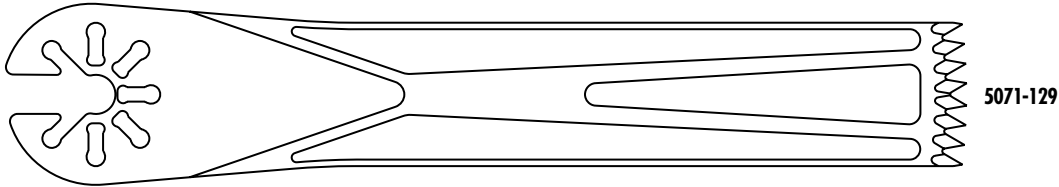
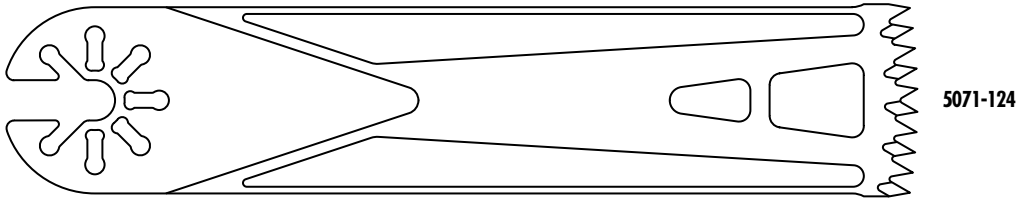

Shaded blades indicate coating
Products shown at actual size.

All products may not be available in all markets.

Large Bone Knee Blades

Indication for Use: Total Knee Arthroplasty



Stryker Blades

For use with: System 2000, System 4 & 5

Cat. No.	Width (mm)	Length (mm)	Material Thickness (mm)	Cut Thickness (mm)	View Illustration
5072-145	9.12	25.22	0.64	0.64	Page 36
5072-140	29.46	58.70	0.64	0.64	Page 36
5072-100	25.00	73.79	0.64	0.64	Page 36
5072-150	12.50	73.80	0.64	0.64	Page 36
5072-143	25.40	90.00	0.80	0.80	Page 36
5072-105	24.82	73.79	0.89	0.89	Page 37
5072-109	20.70	85.04	0.89	0.89	Page 37
5072-102	24.82	90.47	0.89	0.89	Page 37
5072-195	19.50	80.00	0.90	0.90	Page 37
5072-152	12.50	82.18	1.20	1.20	Page 37
5072-151	25.00	85.67	1.20	1.20	Page 37
5072-142	25.40	90.00	1.20	1.20	Page 37
5072-218	25.00	98.50	1.24	1.24	Page 37
5072-185	18.50	104.00	1.24	1.24	Page 38
5072-110	24.82	73.79	1.27	1.27	Page 38
5072-111	24.82	80.14	1.27	1.27	Page 38
5072-158	12.50	82.20	1.27	1.27	Page 38
5072-183	29.00	84.47	1.27	1.27	Page 38
5072-101	19.50	86.00	1.27	1.27	Page 38
5072-181	19.50	86.00	1.27	1.27	Page 38
5072-177	25.00	82.42	1.37	1.37	Page 38
5072-176	25.00	80.14	1.50	1.50	Page 38

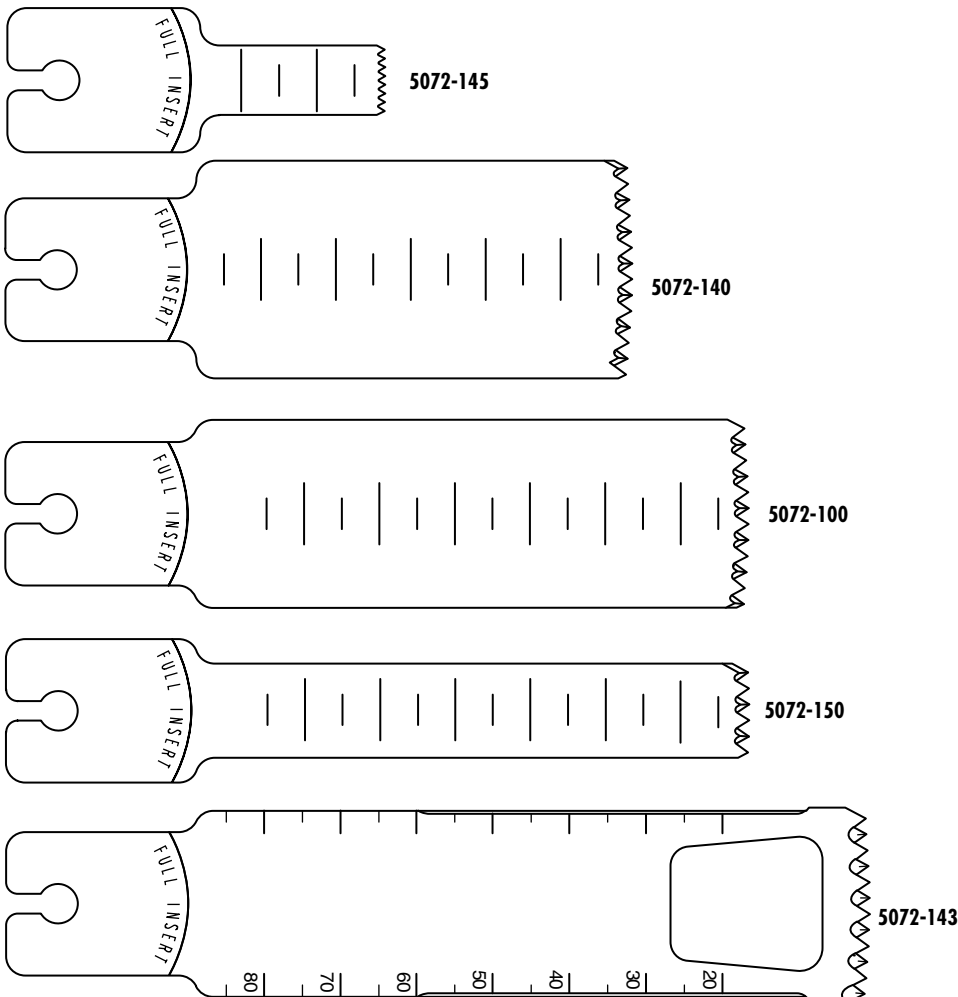

Products shown at actual size.

All products may not be available in all markets.

Large Bone Knee Blades

Indication for Use: Total Knee Arthroplasty

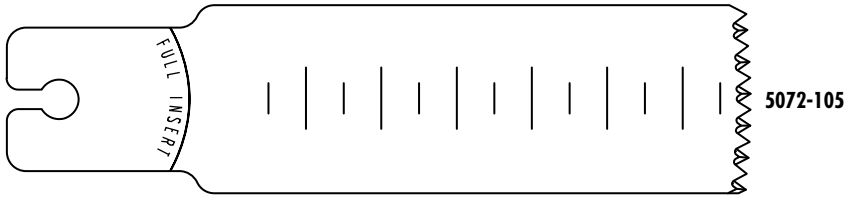

5072-105

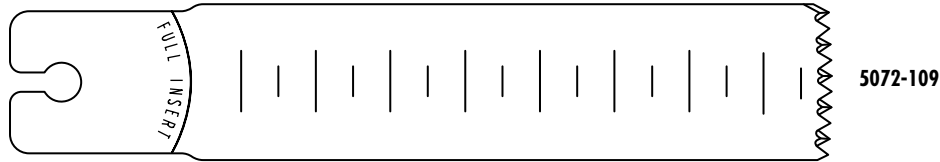

5072-109

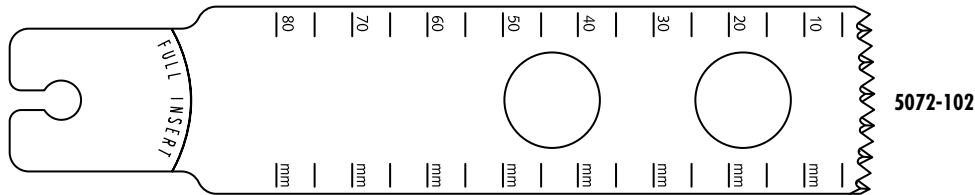

5072-102

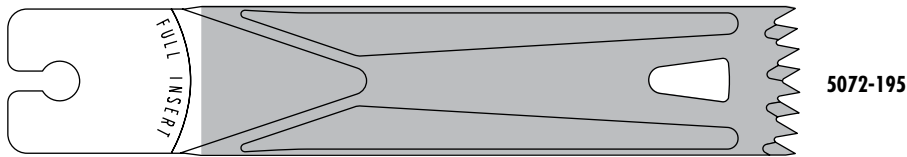

5072-195

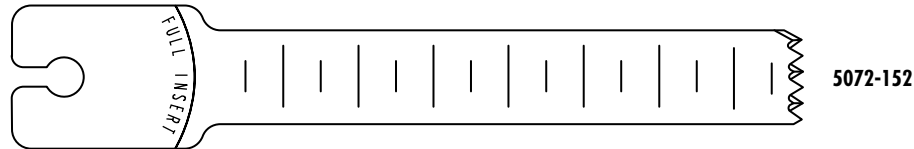

5072-152

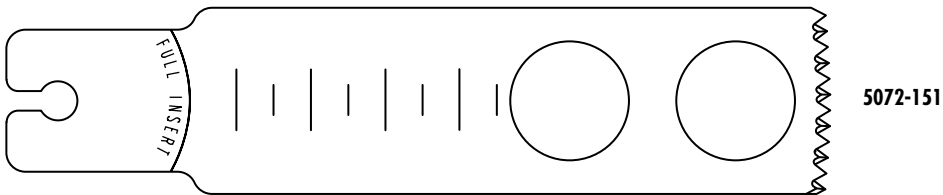

5072-151

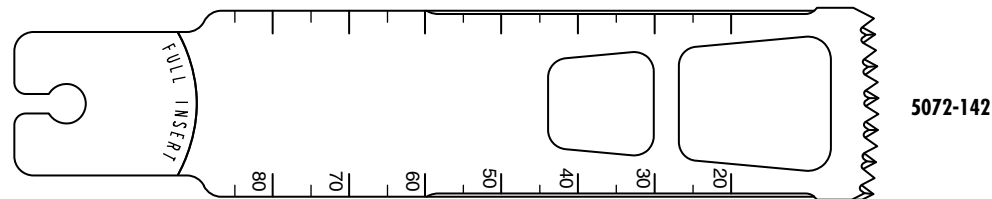

5072-142

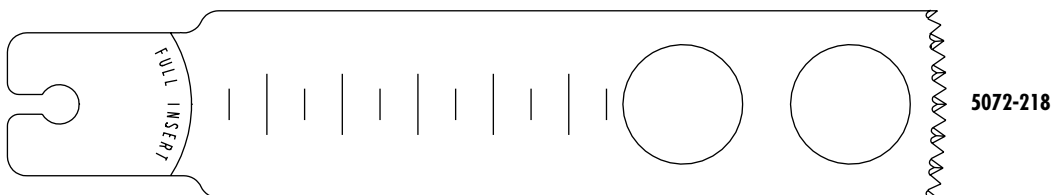

5072-218

Shaded blades indicate coating
 Products shown at actual size.
 All products may not be available in all markets.

Large Bone Knee Blades

Indication for use: Total Knee Arthroplasty



5072-185

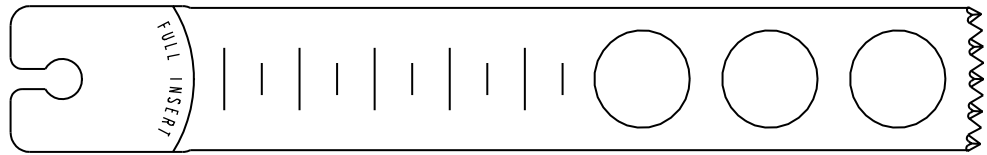

5072-110

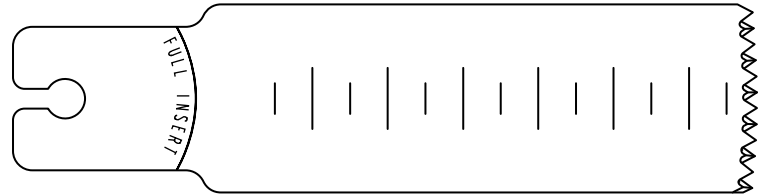

5072-111

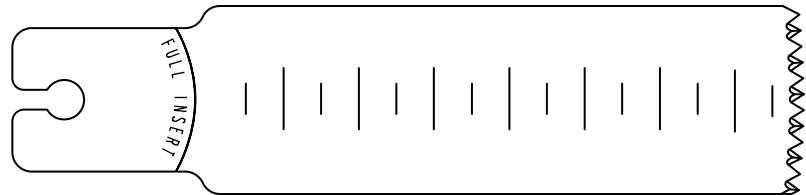

5072-158

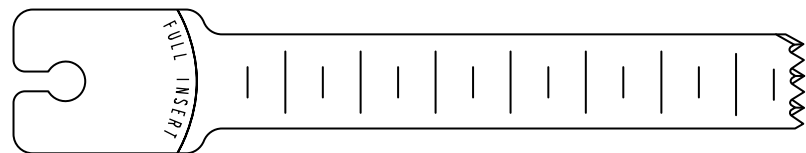

5072-183

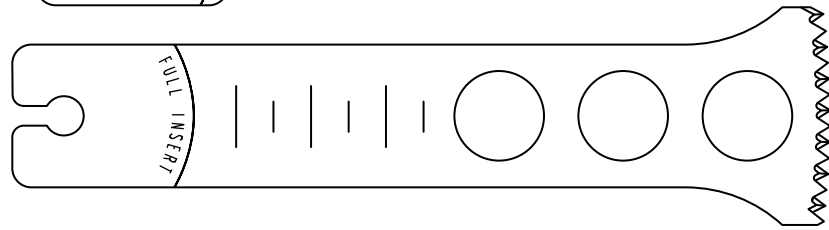

5072-101

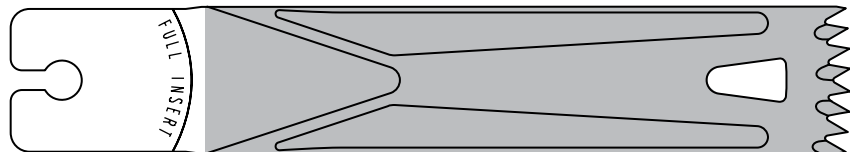

5072-181

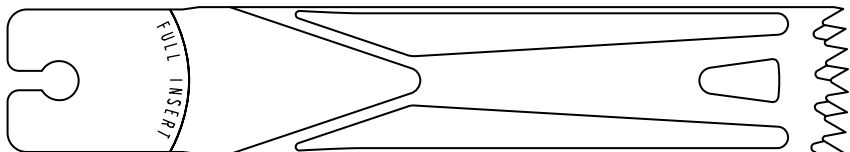

5072-177

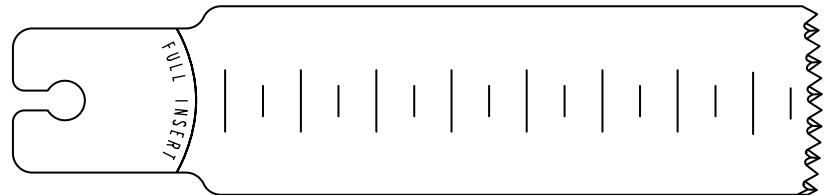

5072-176

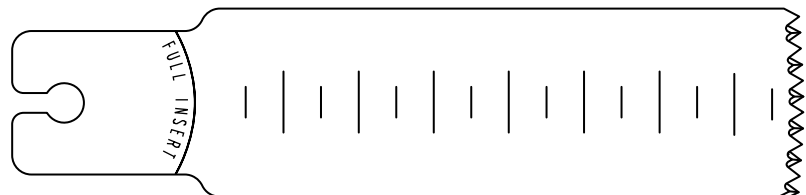

Shaded blades indicate coating
Products shown at actual size.

All products may not be available in all markets.

Graft Harvesting Blades

Cat. No.	Depth Stop (mm)	Width (mm)	Material Thickness (mm)	Cut Thickness (mm)
5071-105	20.00	16.50	0.40	5.00
5071-106	20.00	16.50	0.40	6.00
5071-107	20.00	16.50	0.40	7.00
5071-108	20.00	16.50	0.40	8.00
5071-109	20.00	16.50	0.40	9.00
5071-110	20.00	16.50	0.40	10.00
5071-111	20.00	16.50	0.40	11.00
5071-112	20.00	16.50	0.40	12.00
5071-113	20.00	16.50	0.40	13.00

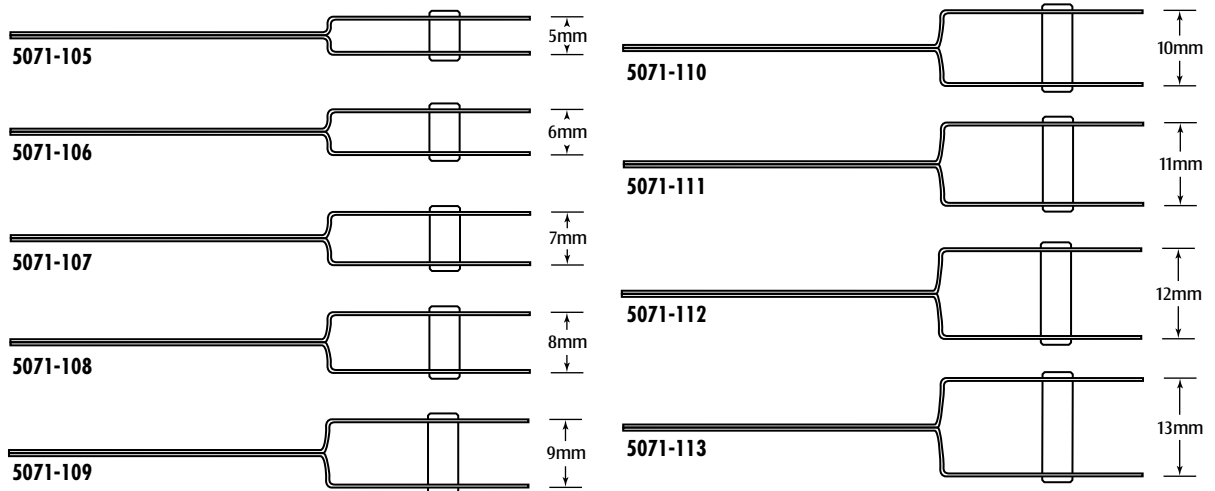

ACL Blades

Cat. No.	Width (mm)	Length (mm)	Material Thickness (mm)	Cut Thickness (mm)
5071-127	8.50	38.00	0.40	0.80
5071-135	5.00	30.00	0.60	1.10
5071-246	5.50	25.50	0.60	0.80
5071-236*	9.12	25.22	0.64	0.64
5071-571	9.50	30.00	0.64	0.84
5071-133	9.50	25.50	0.40	0.60
5071-134	9.00	41.00	0.40	0.60

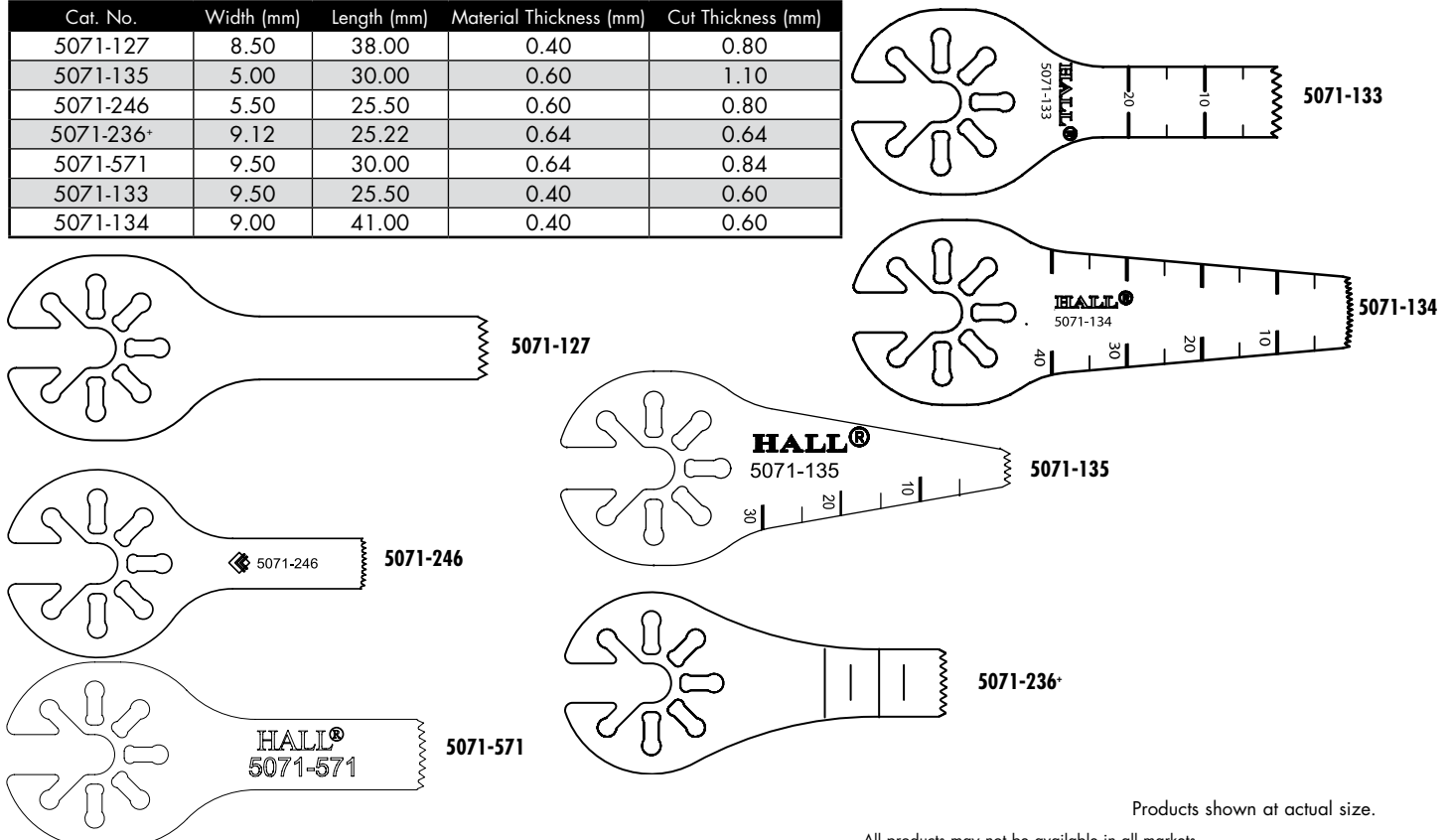

Products shown at actual size.

All products may not be available in all markets.

Large Bone Oscillating Blades

Indications for Use: Total Hip Arthroplasty
and Large Bone Trauma



Oscillating Blades

Cat. No.	Width (mm)	Length (mm)	Material Thickness (mm)	Cut Thickness (mm)	View Illustration
5071-132	19.50	41.00	0.40	0.80	Page 40
5071-553	19.50	63.00	0.60	0.90	Page 40
5071-551	32.50	63.00	0.60	0.90	Page 40
5071-550	49.00	63.00	0.60	0.90	Page 41
5071-552	13.50	64.00	0.60	0.90	Page 41
5071-166	32.00	64.00	0.80	0.90	Page 41
5071-186	32.00	64.00	0.80	0.90	Page 41
5071-556	33.50	64.00	0.80	0.90	Page 41
5071-177	19.50	71.00	0.80	0.90	Page 41
5071-187	19.50	71.00	0.80	0.90	Page 42
5071-572	19.50	71.00	0.80	0.90	Page 42
5071-178	19.50	80.00	0.80	0.90	Page 42
5071-188	19.50	80.00	0.80	0.90	Page 42
5071-174	19.50	86.00	0.80	0.90	Page 42
5071-143	25.40	90.00	0.80	0.90	Page 42
5071-560	25.40	95.00	0.86	1.00	Page 42
5071-557	12.50	73.80	0.63	1.06	Page 4
5071-554	19.50	71.00	1.20	1.40	Page 43
5071-141	19.50	80.00	1.20	1.40	Page 43
5071-140	25.40	80.00	1.20	1.40	Page 43
5071-142	25.40	90.00	1.20	1.40	Page 43
5071-555	33.00	71.00	1.20	1.50	Page 43
5071-145	13.00	72.00	1.20	1.50	Page 43

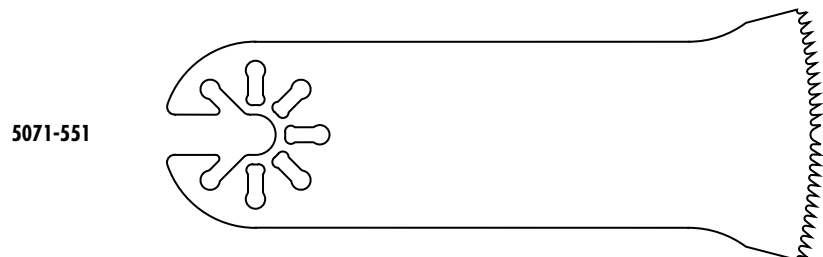
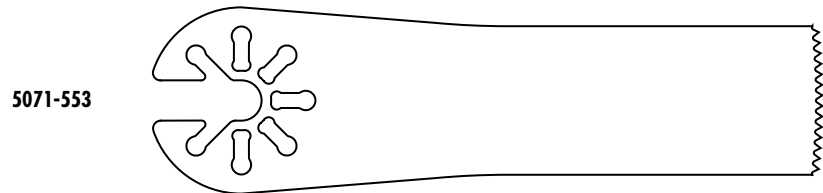
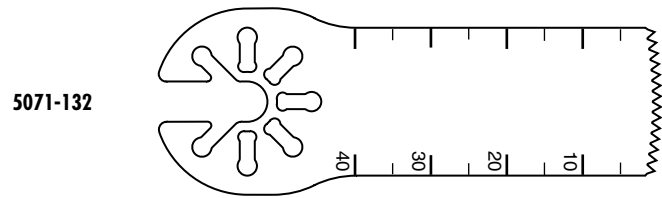

Products shown at actual size.

All products may not be available in all markets.

Large Bone Oscillating Blades

Indications for Use: Total Hip Arthroplasty
and Large Bone Trauma

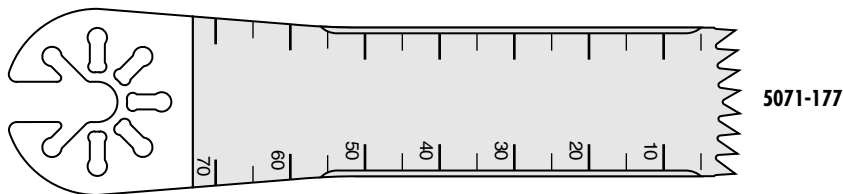
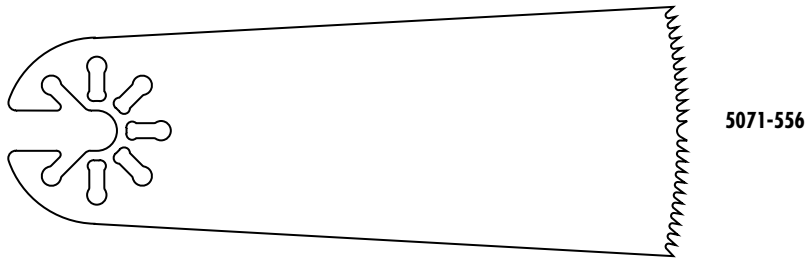
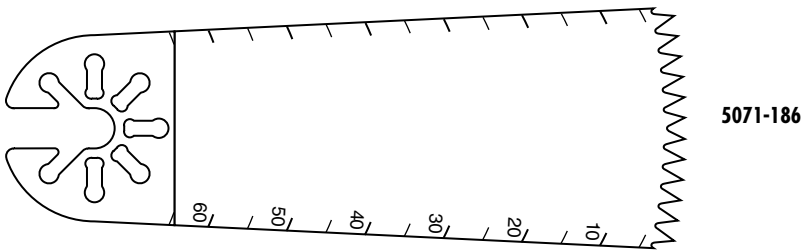
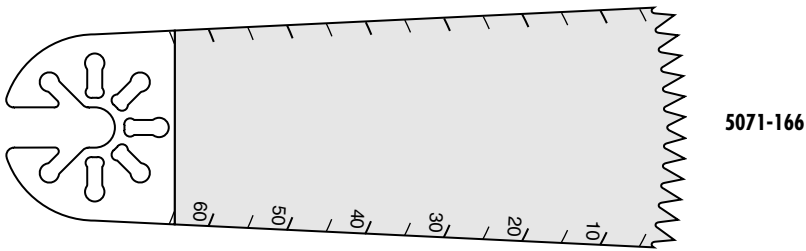
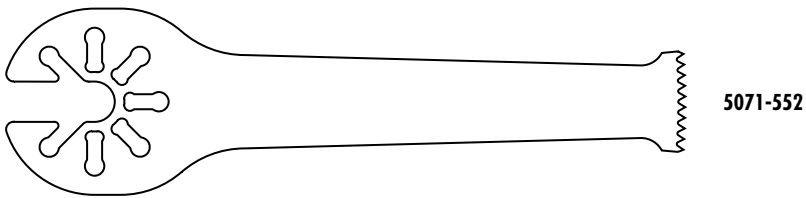
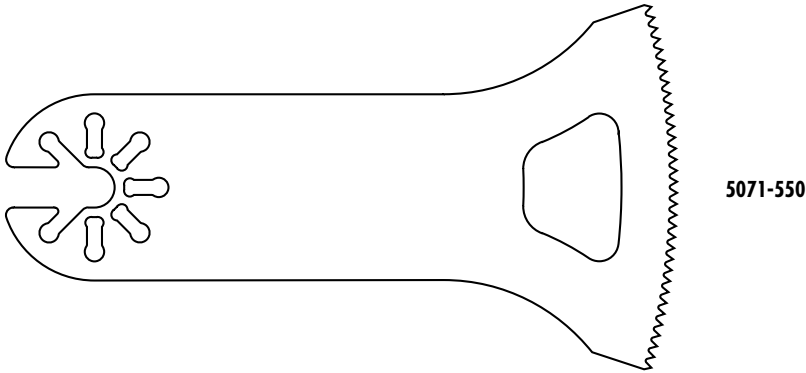

Shaded blades indicate coating
Products shown at actual size.
All products may not be available in all markets.

Large Bone Oscillating Blades

Indications for Use: Total Hip Arthroplasty
and Large Bone Trauma



5071-187

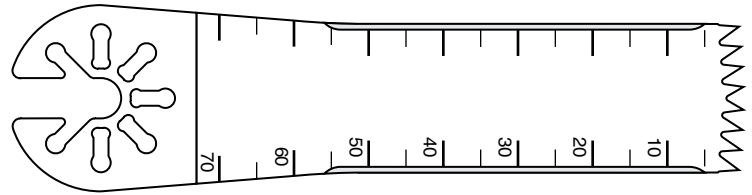

5071-572

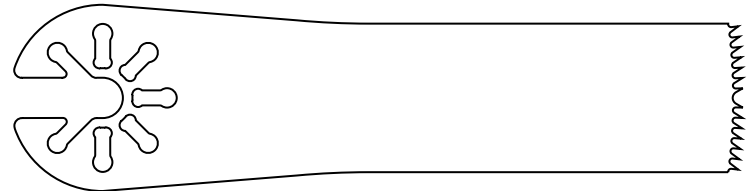

5071-178

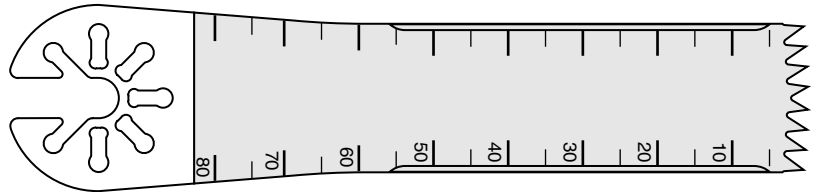

5071-188

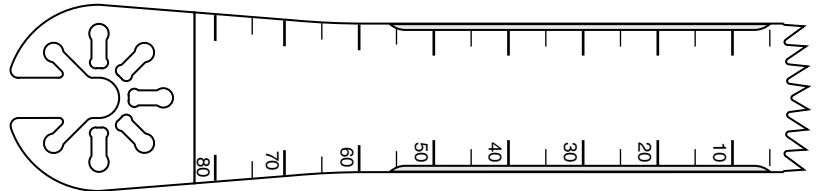

5071-174

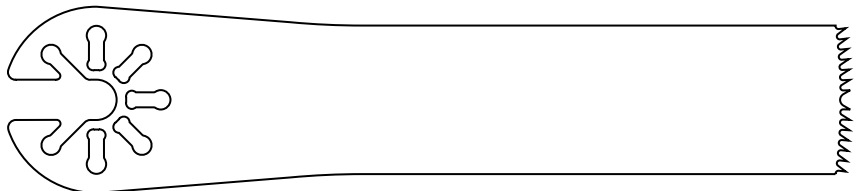

5071-143

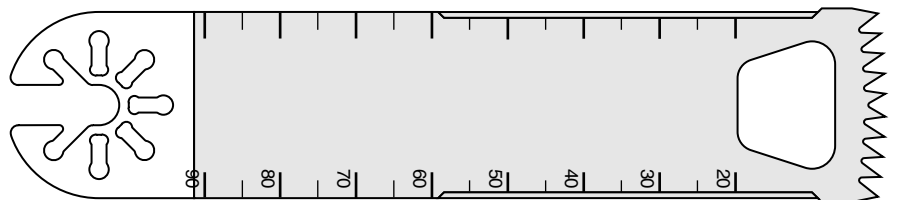

5071-560

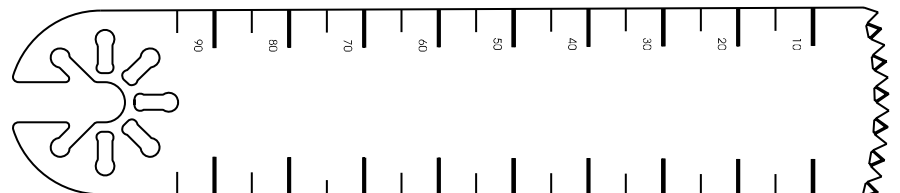

5071-557

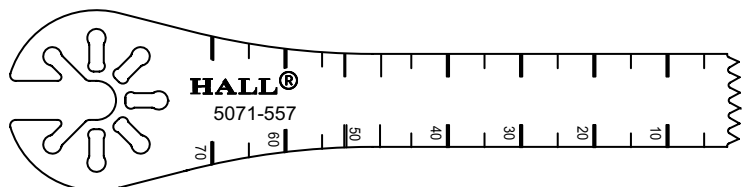

Shaded blades indicate coating
Products shown at actual size.
All products may not be available in all markets.

Large Bone Oscillating Blades

Indications for Use: Total Hip Arthroplasty and Large Bone Trauma

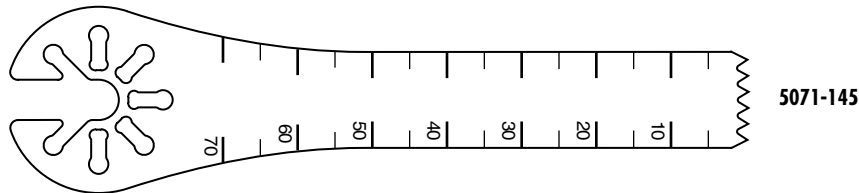
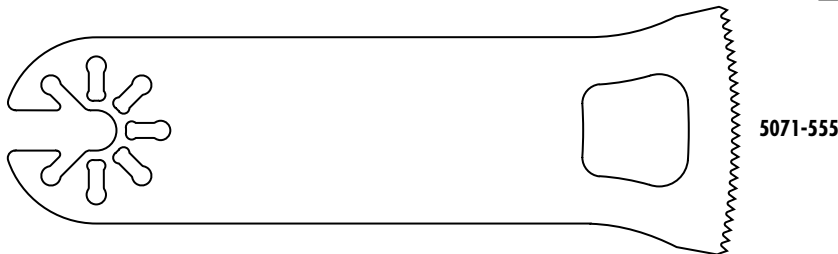
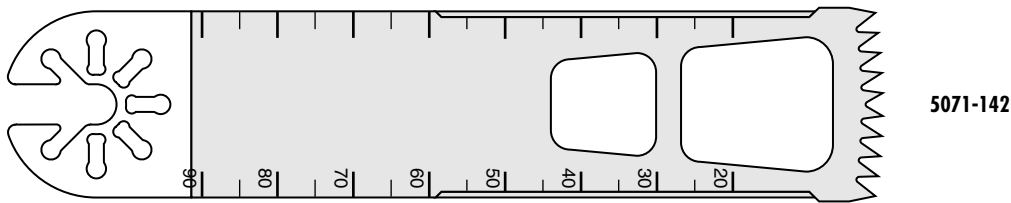
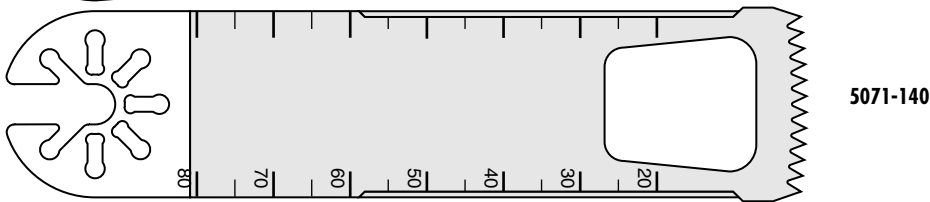
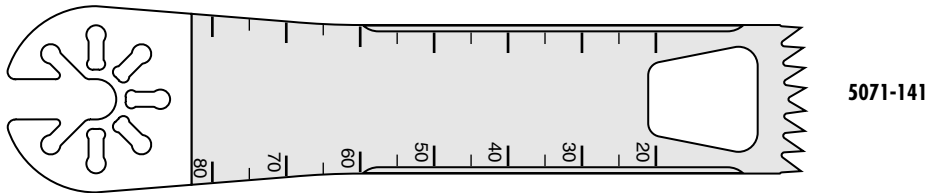
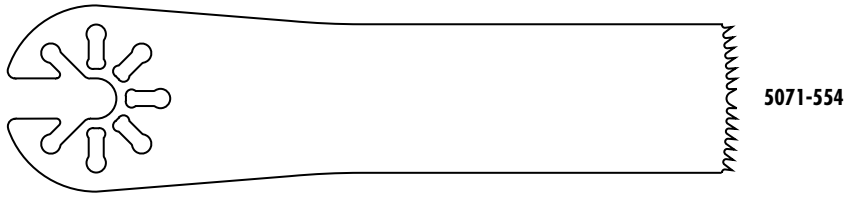

Oscillating Abraders

Cat. No.	Width	Length
5071-175	20	45.7

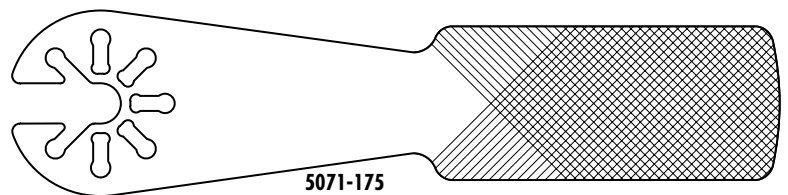

Shaded blades indicate coating*
 Products shown at actual size.
 All products may not be available in all markets.

Large Bone Reciprocating Blades

Indications for Use: Total Joint Arthroplasty and Large Bone Trauma



Hall® Reciprocating Blades

Cat. No.	Width (mm)	Length (mm)	Material Thickness (mm)	Cut Thickness (mm)
5052-260	12.50	38.00	0.40	0.60
5052-179	12.50	76.00	0.90	0.90
5052-259	9.40	54.50	0.60	1.00
5052-173	12.50	73.50	0.80	1.00
5052-258	12.50	89.00	0.60	1.00
5052-291	12.50	76.00	1.20	1.20
5052-276	13.00	48.00	1.50	1.50
5052-281	9.40	54.50	1.50	1.50
5052-261	12.50	89.00	1.50	1.60

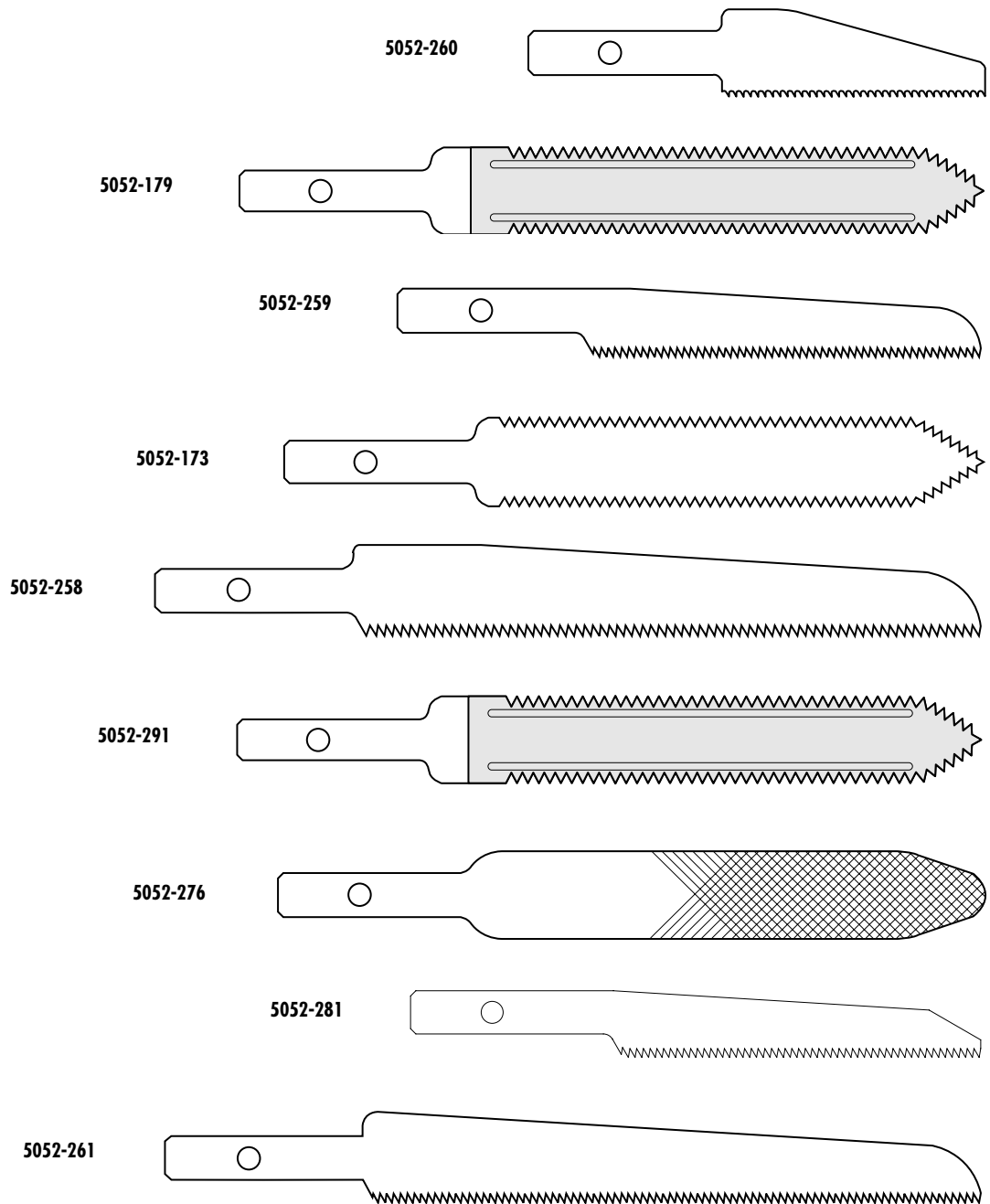

Shaded blades indicate coating
Products shown at actual size.

All products may not be available in all markets.

Stryker Reciprocating Blades

For use with: Sytem 2000, System 4 and 5

Cat. No.	Width (mm)	Length (mm)	Material Thickness (mm)	Cut Thickness (mm)
5052-334	12.50	73.50	0.60	0.60
5052-332	12.00	76.00	0.80	0.80
5052-135	12.50	76.00	0.90	0.90
5052-333	12.00	76.00	1.30	1.30

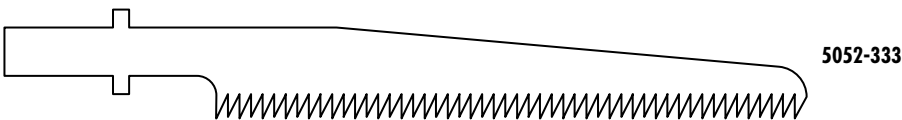
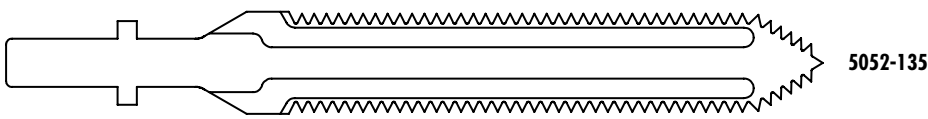
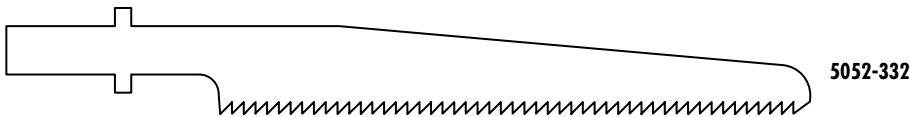
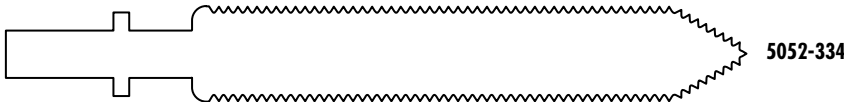

Products shown at actual size.
All products may not be available in all markets.

MicroPower® and Micro100™ Sagittal Saw Blades

Indications for Use: Small Bone



Sagittal Saw Blades

Cat. No.	Tooth	Width (mm)	Length (mm)	Material Thickness (mm)	Cut Thickness (mm)
5023-144	Fine	5.5	18.5	0.4	0.6
5023-118	Fine	9.5	25.5	0.4	0.6
5023-130	Coarse	19.5	25.5	0.4	0.6
5023-131	Coarse	19.5	41.0	0.4	0.6
5023-132	Coarse	5.5	25.5	0.4	0.6
5023-133	Coarse	14.0	41.0	0.4	0.6
5023-137	Coarse	14.0	25.5	0.4	0.6
5023-138	Fine	9.5	25.5	0.4	0.6
5023-139	Fine	4.5	25.5	0.4	0.6
5023-140	Tapered/Fine	9.5	41.0	0.4	0.6
5023-141	Fine	6.0	34.0	0.4	0.6
5023-142	Fine	4.0	34.0	0.4	0.6
5023-143	Coarse	9.5	25.5	0.4	0.6
5023-244	Fine	4.0	6.0	0.4	0.6
5044-145	Fine	10.0	18.5	0.4	0.6

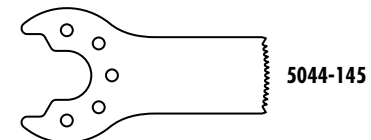
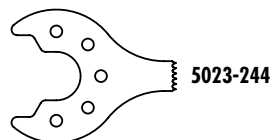
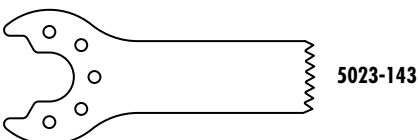
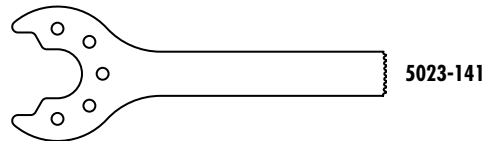
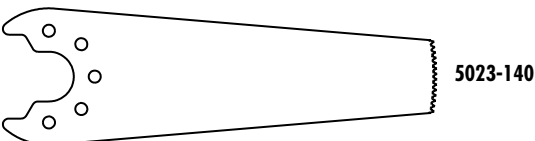
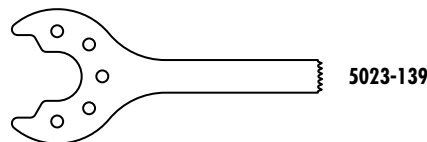
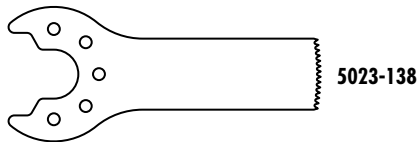
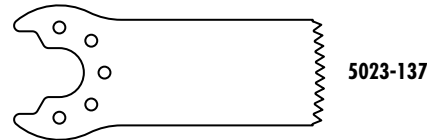
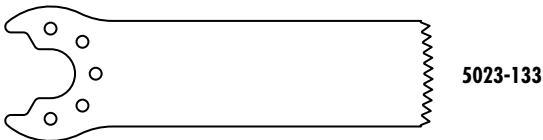
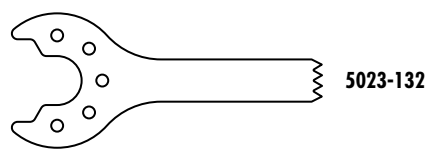
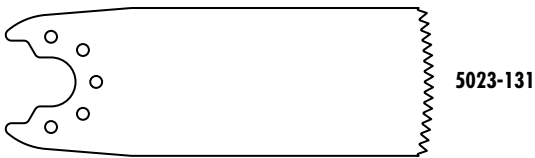
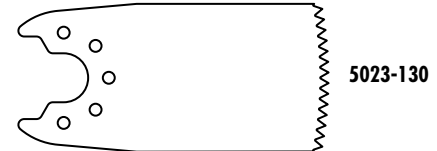
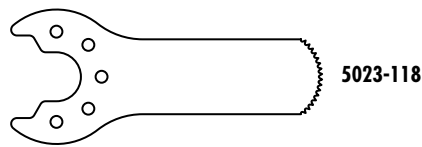
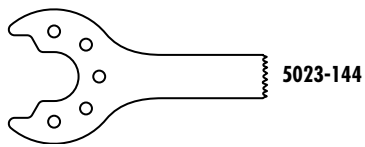

Products shown at actual size.
All products may not be available in all markets.

Angled Sagittal Saw Blades

Cat. No.	Tooth	Angle	Width (mm)	Length (mm)	Material Thickness (mm)	Cut Thickness (mm)
5023-128	Fine	70 Degree	9.5	7.5	0.4	0.6
5023-129	Fine	70 Degree	9.5	13.5	0.4	0.6
5023-134	Coarse	90 Degree	5.5	9.0	0.4	0.6
5023-135	Coarse	45 Degree	5.5	18.0	0.4	0.6
5023-136	Coarse	90 Degree	14.0	15.5	0.4	0.6

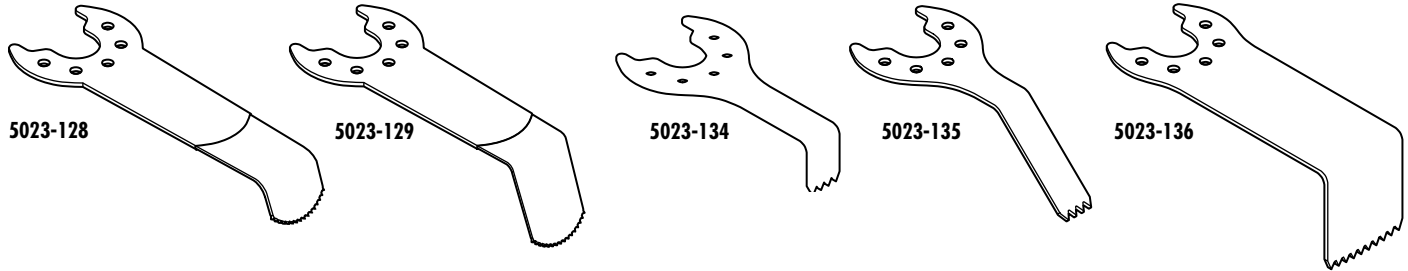

ACL Blades

Cat. No.	Tooth	Edge	Depth Stop (mm)	Width (mm)	Length (mm)	Material Thickness (mm)	Cut Thickness (mm)
8703	Fine	Straight	8.0 with guide/12 without guide	9.5	25.5	0.4	0.6
5023-186	Coarse	Straight	None	8.5	38.0	0.4	0.74
5023-182	Coarse	Straight	None	19.0	41.0	0.4	0.69
5023-183	Fine	Straight	None	9.5	25.5	0.4	0.6
5023-184	Tapered/Fine	Straight	None	9.5	41.0	0.4	0.6
5023-185	Tapered/Coarse	Straight	None	6.5	30.0	0.4	0.6
C8803	Fine	Straight	8.0 with guide/12 without guide	9.4	41.0	0.38	0.6
C8804	Fine	Straight	8.0 Freehand	9.4	41.0	0.38	0.6
C8806	Fine	Straight	10.0 Freehand	9.4	41.0	0.38	0.6

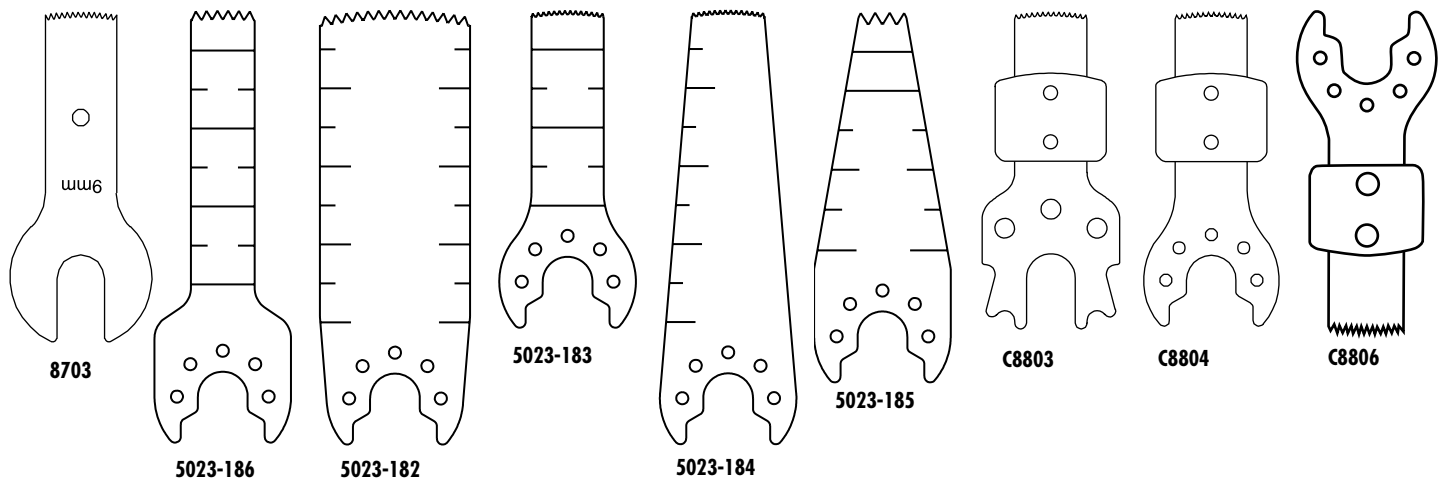

Products shown at actual size.
All products may not be available in all markets.

MicroPower® and Micro 100™ Sagittal Saw Blades

Indications for Use: Small Bone



Dermabraders

Cat. No.	Tooth	Edge	Width (mm)	Length (mm)	Material Thickness (mm)
5023-055	Abrader	Straight	25.0	6.3	3.8
5023-056	Abrader	25 Degree	25.0	6.3	3.8
5023-057	Abrader	70 Degree	25.0	6.3	3.8

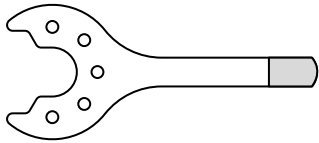

5023-055

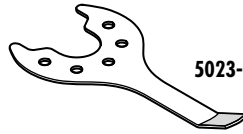

5023-056

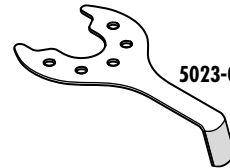

5023-057

Graft Harvesting Blades

Cat. No.	Depth Stop (mm)	Width (mm)	Material Thickness (mm)	Cut Thickness (mm)
5023-405	20.0	16.5	0.4	5.0
5023-406	20.0	16.5	0.4	6.0
5023-407	20.0	16.5	0.4	7.0
5023-408	20.0	16.5	0.4	8.0
5023-409	20.0	16.5	0.4	9.0
5023-410	20.0	16.5	0.4	10.0
5023-411	20.0	16.5	0.4	11.0
5023-412	20.0	16.5	0.4	12.0
5023-413	20.0	16.5	0.4	13.0

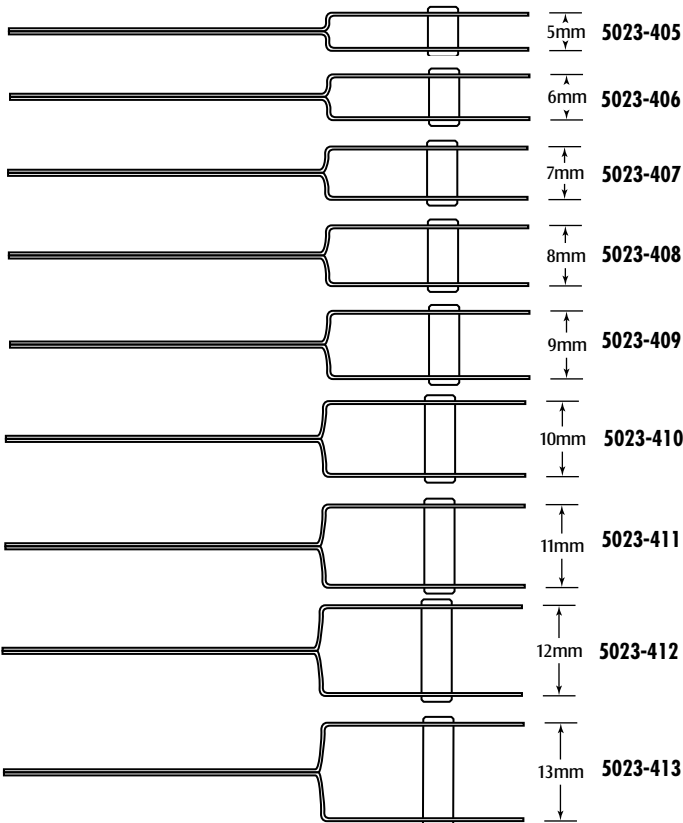

Products shown at actual size.
All products may not be available in all markets.

Oscillating Saw Blades

Cat. No.	Tooth	Edge	Width (mm)	Length (mm)	Material Thickness (mm)	Cut Thickness (mm)
5023-160	Fine	Straight	5.5	12.0	0.4	0.6
5023-161	Fine	Straight	10.0	12.0	0.4	0.6
5023-162	Fine	Straight	5.5	18.5	0.4	0.6
5023-163	Fine	Straight	10.0	18.5	0.4	0.6
5023-164	Fine	Straight	5.5	28.5	0.4	0.6
5023-165	Fine	Radial	10.0	28.5	0.4	0.6
5023-166	Fine	Radial	18.5	28.5	0.4	0.6
5023-169	Fine	Straight	10.0	35.0	0.4	0.6

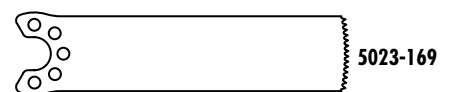
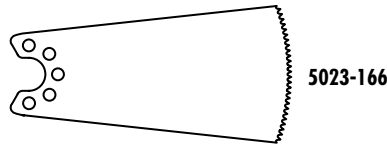
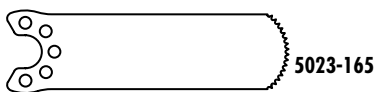
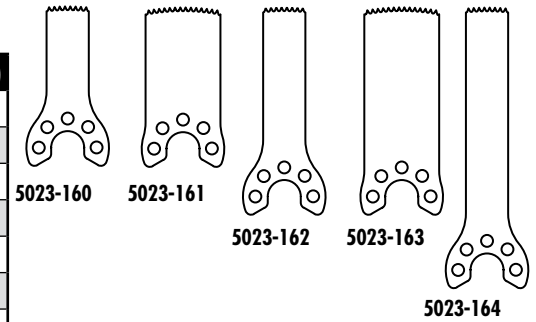

Angled Oscillating Saw Blades

Cat. No.	Tooth	Edge	Width (mm)	Length (mm)	Material Thickness (mm)	Cut Thickness (mm)
5023-258	Fine	Radial/20 Degree	10.0	9.0	0.4	0.6
5023-259	Fine	Radial/20 Degree	10.0	13.5	0.4	0.6
5023-167	Fine	20 Degree	5.5	13.0	0.4	0.6
5023-168	Fine	Radial/20 Degree	10.0	13	0.4	0.6

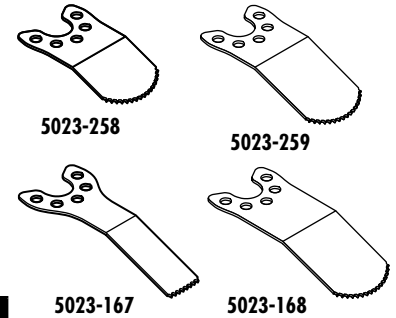

Intra-Oral Blades *Not for use with Micro100™

Cat. No.	Tooth	Width (mm)	Length (mm)	Material Thickness (mm)	Cut Thickness (mm)	Cutting Depth (mm)
5023-101*	Coarse	11.5	7.0	0.4	0.6	7.0
5023-102*	Coarse	11.5	12.0	0.4	0.6	12.0
5023-103*	Coarse	9.0	12.0	0.4	0.6	12.0
5023-104*	Coarse	5.0	12.0	0.4	0.6	12.0

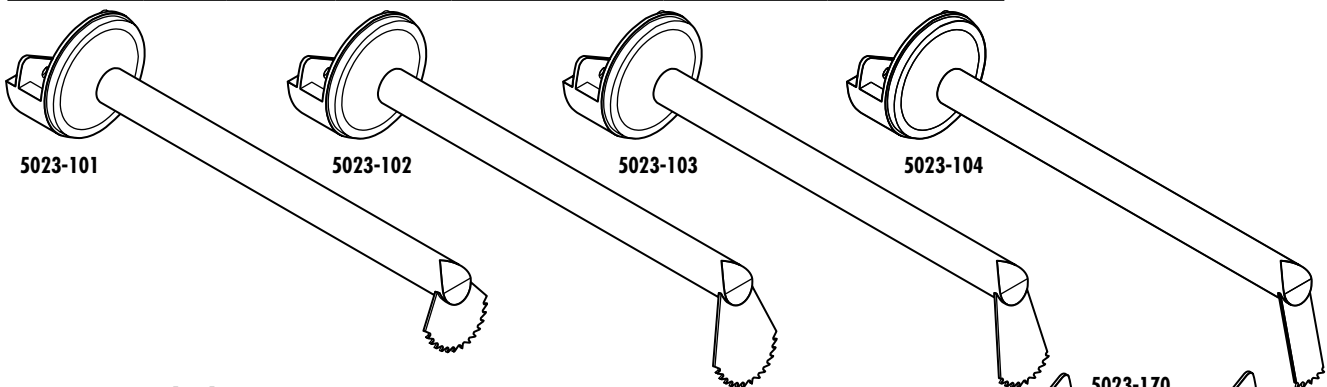

Crescentic Blades

Cat. No.	Tooth	Width (mm)	Length (mm)	Material Thickness (mm)	Cut Thickness (mm)	Cutting Depth (mm)
5023-170	Fine	9.0	12.0	0.4	0.6	12.0
5023-171	Fine	13.5	25.5	0.4	0.6	25.5
5023-172	Fine	18.0	32.0	0.4	0.6	32.0
5023-176	Fine	13.5	32.0	0.4	0.6	32.0

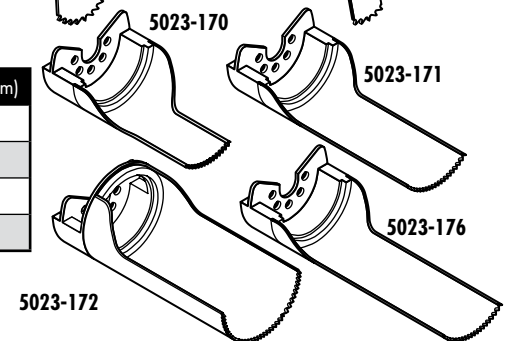

Products shown at actual size.

All products may not be available in all markets.

MicroPower® and Micro 100™ Reciprocating Saw Blades and Rasps



Indications for Use: Small Bone

Reciprocating Rasp

Cat. No.	Shank	Width (mm)	Length (mm)
5053-080	Round	5.5	9.5
5053-081	Round	6.5	12.5
5053-082	Round	5.5	9.5
5053-083	Round	6.5	12.5
5053-084	Round	5.3	24.5
5053-085	Round	9.5	30.5

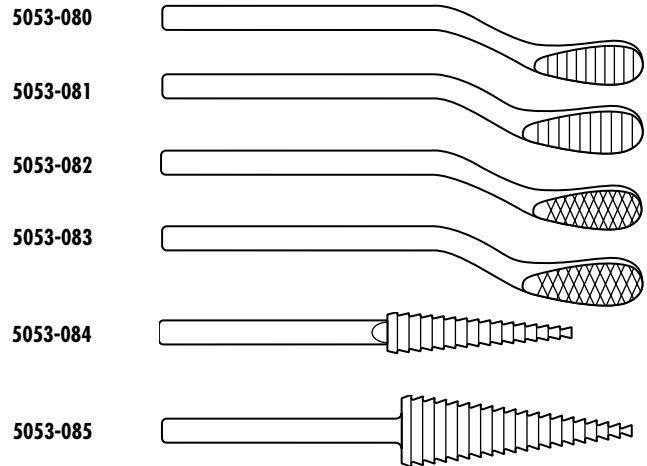

Reciprocating Saw Blades

Cat. No.	Shank	Length (mm)	Material Thickness (mm)
5053-220	Flat	25.5	0.40
5053-221	Flat	38.0	0.40
5053-054	Round	25.0	0.60
5053-122	Flat	25.5	0.25
5053-126	Round	28.0	0.60

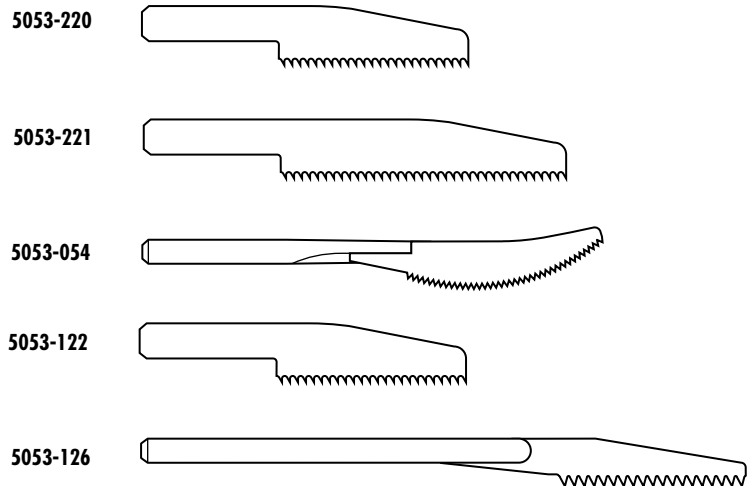

Depth Limiting Reciprocating Saw Blades

Cat. No.	Shank	Length (mm)	Material Thickness (mm)	Cut Depth (mm)
5053-050	Round	7.0	0.60	5.0
5053-051	Round	17.0	0.60	4.0
5053-052	Round	23.0	0.60	5.0
5053-053	Round	25.0	0.60	7.0

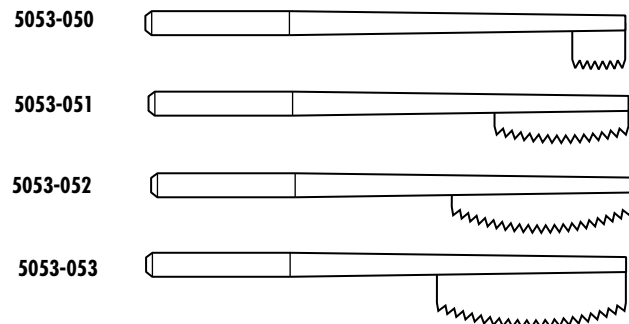

Products shown at actual size.

All products may not be available in all markets.

MicroPower & Micro100 Bur Guards	Round Fluted												
	Flutes (mm)	4	6	6	8	6	8	6	8	8	10	10	10
Diameter (mm)	0.5	1.0	1.5	1.8	2.0	2.3	2.4	3.0	4.0	5.0	6.0	6.5	
1375-012				5091-222	5091-221	5091-224	5091-223	5091-225	5091-226	5091-228	5091-230	M60R	5091-232
1375-011			5092-220	5092-222	L18R	5092-224	L23R		5092-226	5092-228	5092-230	L60R	5092-232
1375-023		5093-221	5093-220			5093-224			5093-226	5093-228	5093-230	X60R	5093-232
1387-022									5092-236				

MicroPower & Micro100 Bur Guards	Fine Round Diamond						
	Diameter (mm)	1.0	2.0	3.0	4.0	5.0	6.0
1375-012			5091-260		5091-264	5091-268	M60D
1375-011		L10D	5092-260	5092-262	5092-264	5092-266	5092-268
1375-023		X10D	5093-260	5093-262	5093-264	5093-266	

MicroPower & Micro100 Bur Guards	Wire Pass Burs			
	Flutes (mm)	2	2	2
Diameter (mm)	1	1.5	2	
Length (mm)	19	19	19	
1375-035		5090-247	5090-248	5090-249
1375-036		5090-247	5090-248	5090-249
1375-011		5092-247		
1375-032		5092-247		
1375-012		5091-247	5091-248	5091-249

MicroPower & Micro100 Bur Guards	Swanson Reamers				
	Flutes (mm)	4	6	6	8
Diameter (mm)	2.0	3.0	4.0	5.0	
1375-012		5091-242	5091-243	5091-244	5091-245

MicroPower & Micro100 Bur Guards	Dermabraders - Fine Diamond					N/A	N/A	N/A	N/A	
	Diameter (mm)	2.0	4.0	6.0	4.0	4.0	7.0	12.0	10.0	2.0
Bur Head Length (mm)					8.0	15.0	15.0	15.0	15.0	19.0
1375-012		5091-260	5091-264	5091-268	5091-270	5091-080	5091-081	5091-082	5091-083	
1375-011					5092-270					5092-274
1375-021										5092-274

Bur Shank Diameter 2.34mm (0.82")

Products shown at actual size.
All products may not be available in all markets.

MicroPower® and Micro100™ Small Bone Burs



Indications for Use: Small Bone

	Straight Side-Cutting Burs															
	Flutes (mm)	6	6	6	6	6	6	6	6	6	6	6	6	6	6	
	Diameter (mm)	1.0	1.1	1.2	1.3	1.3	1.5	1.5	1.5	1.6	1.6	1.7	1.7	1.7	2.1	
	MicroPower & Micro100 Bur Guards	Bur Head Length (mm)	5.0	5.0	4.9	9.9	9.9	5.1	8	10.0	4.3	7.5	12.0	9.9	9.9	9.9
1375-012		5091-201	M10S	5091-216		M13S	5091-204		5091-202	5091-217	M15S			M17S	M20S	
1375-011					L13S		5092-204					5092-203	L17S			
1375-020												5092-203				
1375-035 & 1375-036							5089-208									

	Tapered Side-cutting									
	Diameter (mm)	0.8	1.1	1.2	1.2	1.2	1.5	1.6	1.6	
	MicroPower & Micro100 Bur Guards	Bur Head Length (mm)	4.9	9.9	9.9	3.7	9.9	9.9	21.6	4.3
1375-012		5091-215	M10T	M12T	5091-219		M15T	M20T	5091-218	
1375-011						L12T				

	Tapered Side-cutting		N/A					
	Diameter (mm)	1.6	1.6	2.0	2.0	2.0	2.0	
	MicroPower & Micro100 Bur Guards	Bur Head Length (mm)	21.9	21.9	7.5	19.0	7.5	19
1375-012				5091-206	5091-214			
1375-011		L20T	L17T			5092-206	5092-214	



	Barrel Burs			
	Flutes (mm)	6	6	
	Diameter (mm)	2.0	4.0	
	MicroPower & Micro100 Bur Guards	Bur Head Length (mm)	10.0	10.0
1375-012		5091-252	5091-254	
1375-011		5092-252	5092-254	

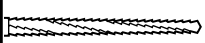
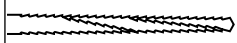

	Oval Burs					
	Flutes (mm)	8	8	8	8	
	Diameter (mm)	4.0	5.5	4.0	5.5	
	MicroPower & Micro100 Bur Guards	Bur Head Length (mm)	8.0	10.0	7.9	10.0
1375-012		5091-236	5091-238	M40B	M55B	
1375-011		5092-236	5092-238	L40B	L55B	
1375-023		5093-236	5093-238	X40B	X55B	
1387-022		5092-236				

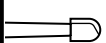
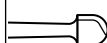
Products shown at actual size.
All products may not be available in all markets.

	Lindemann Burs		
	Flutes (mm)	4	4
	Diameter (mm)	1.6	1.6
MicroPower & Micro100 Bur Guards	Bur Head Length (mm)	31.0	43.7
1375-012		5091-212	
1375-011			5092-212

	Cylindrical		
	Flutes (mm)	2	2
	Diameter (mm)	3.0	4.0
MicroPower & Micro100 Bur Guards	Bur Head Length (mm)	4.0	4.0
1375-011		5092-291	5092-292
1375-023		5093-291	

	Cone Burs			
	Flutes (mm)	8.0	12	12.0
	Diameter (mm)	4.5	4.5	4.5
MicroPower & Micro100 Bur Guards	Bur Head Length (mm)	12.0	12	12.0
1375-012		M45C		
1375-011			L45C	
1375-023				X45C

	Tapered Cross-cut Fissure Burs			
	Flutes (mm)	701 Type	702 Type	703 Type
	Diameter (mm)	1.2	1.6	2.1
MicroPower & Micro100 Bur Guards	Bur Head Length (mm)	2.3	3.8	4.9
1375-012		5091-271	5091-272	5091-213
1375-011		5092-271	5092-272	5092-273

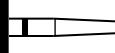
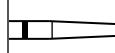
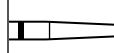
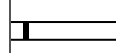
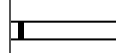
	Heavy Grit Diamond-Microbur. X-Long					
MicroPower & Micro100 bur guards	Diameter	2	3	4	5	6
	Grit	60-70	60-70	40-45	40-45	40-45
1375-033 & 1375-023		5093-282	5093-283	5093-284	5093-285	5093-286
1375-032 & 1375-011		5092-282	5092-283	5092-284	5092-285	5092-286

Products shown at actual size.
All products may not be available in all markets.

Wires and Staples

Indication for Use: Small Bone Trauma



C-Wires

Cat. No.	Tip	Diameter	Length	Quantity
5050-041	Spade	.028" (.7mm)	5" (13cm)	50 per Pkg.
5050-042	Spade	.035" (.9mm)	5" (13cm)	50 per Pkg.
5050-043	Spade	.045" (1.1mm)	5" (13cm)	50 per Pkg.
5050-044	Spade	.062" (1.6mm)	5" (13cm)	50 per Pkg.
5050-046	Trocar	.028" (.7mm)	5" (13cm)	50 per Pkg.
5050-047	Trocar	.035" (.9mm)	5" (13cm)	50 per Pkg.
5050-048	Trocar	.045" (1.1mm)	5" (13cm)	50 per Pkg.
5050-049	Trocar	.062" (1.6mm)	5" (13cm)	50 per Pkg.

Note: To order C-Wires in a box of 5, instead of 50 per package, please order using catalog number 5050-2XX. For example, 5051-241 instead of 5050-041.

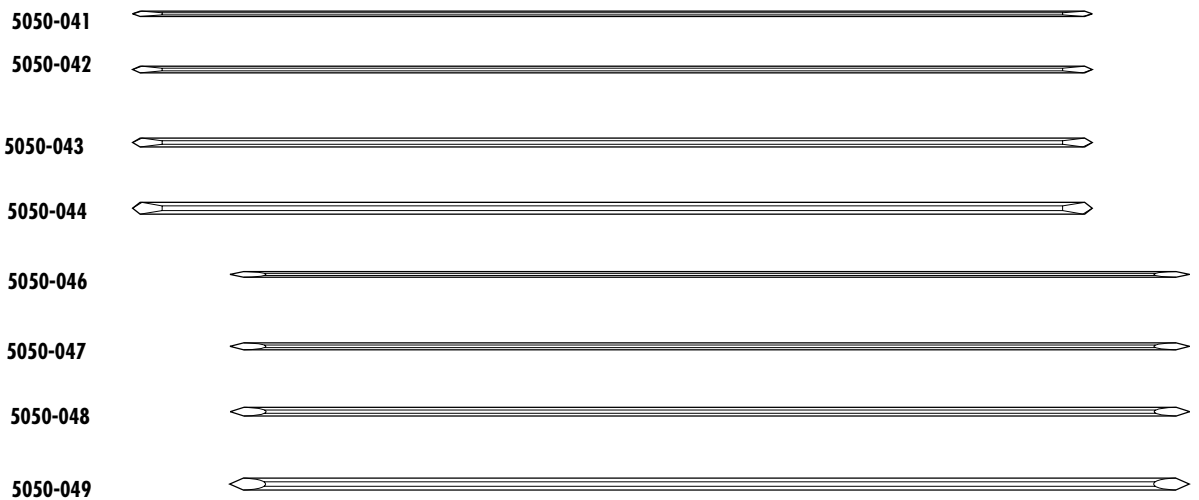

Stapler Cartridges

Cat. No.	Width (mm)	Length (mm)
7707-03	7.0	7.0
7710-03	7.0	10.0
7007-03	10.0	7.0
7010-03	10.0	10.0
7015-03	10.0	15.0
7307-03	13.0	7.0
7310-03	13.0	10.0
7315-03	13.0	15.0
7320-03	13.0	20.0
7610-03	16.0	10.0
7615-03	16.0	15.0
7620-03	16.0	20.0
7625-03	16.0	25.0

Note: 3 cartridges per Pkg.
5 Staples per cartridge.

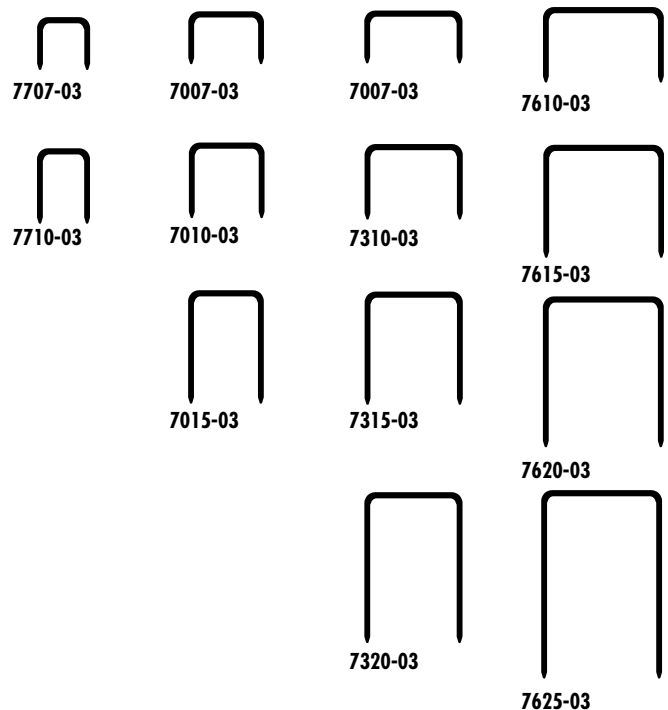

Products shown at actual size.
All products may not be available in all markets.

For use with:

E9005 High Speed Shaver

MicroXcisor® Blade

4.2mm, Irrigated, 10.5cm Working Length, 6/Box..... N9330

Cat. No.

N9330

Lynx® Blade

4.2mm, Irrigated, 10.5cm Working Length, 6/Box..... N9150

N9150

Rhinotec® Cuda® Blade

4.2mm, Bendable to 30°, Irrigated, 10.5cm Working Length, 6/Box E9350

3.7mm, Bendable to 30°, Irrigated, 10.5cm Working Length, 6/Box E9351

4.2mm, Bendable to 45°, 10.5cm Working Length, 6/Box A9350

4.2mm, Irrigated, 10.5cm Working Length, 6/Box..... N9210

3.5mm, 7.6cm Working Length, 6/Box..... C9952

2.9mm, 7.6cm Working Length, 6/Box..... C9951

2.0mm, 7.6cm Working Length, 6/Box..... C9950



Ideal for aggressive removal of ethmoid bone, cartilage and soft tissue



Ideal for aggressive removal of ethmoid bone, cartilage and soft tissue



Ideal for removal of soft tissue

Products not shown at actual size.
All products may not be available in all markets.

E9005 ENT Shaver Blades

Indications for Use: Sinus Surgery



Ideal for aggressive removal of soft tissue, cartilage and thin bone



Ideal for the most gentle removal of soft tissue



Ideal for removal of soft tissue in laryngeal procedures

Products not shown at actual size.
All products may not be available in all markets.

Rhinotec® Gator® Blade

Cat. No.

4.2mm, Bendable to 30°, Irrigated, 10.5cm Working Length, 6/Box	E9360
3.7mm, Bendable to 30°, Irrigated, 10.5cm Working Length, 6/Box	E9361
4.2mm, Bendable to 45°, 10.5cm Working Length, 6/Box	A9360
4.2mm, Irrigated, 10.5cm Working Length, 6/Box.....	N9220
3.5mm, 7.6cm Working Length, 6/Box.....	C9962
2.9mm, 7.6cm Working Length, 6/Box.....	C9961
2.0mm, 7.6cm Working Length, 6/Box.....	C9960

Head and Neck Blade

4.2mm, 11.5cm Working Length, 6/Box.....	N9321
3.5mm, 7.0cm Working Length, 6/Box.....	N9320

Laryngeal Blade

3.7mm, Bendable to 45°, 20.0cm Working Length, 6/Box.....	E9363
---	-------

Rhinotec® Vortex® Router

	Cat. No.
4.5mm, Hooded, 10.8cm Working Length, 6/Box.....	N9370
3.5mm, Hooded, 7.6cm Working Length, 6/Box.....	C9991
2.9mm, Hooded, 7.6cm Working Length, 6/Box.....	C9990



Ideal for aggressive removal of hard bone and cartilage

Curved Vortex Router

4.5mm, 45° Pre-Bent, 11.5cm Working Length, 6/Box.....	N9375
--	-------



45° fixed curve (pre-bent)
Ideal for aggressive removal of hard bone

Otolaryngology Bur

4.0mm, Hooded, 10.8cm Working Length, 6/Box.....	N9390
--	-------

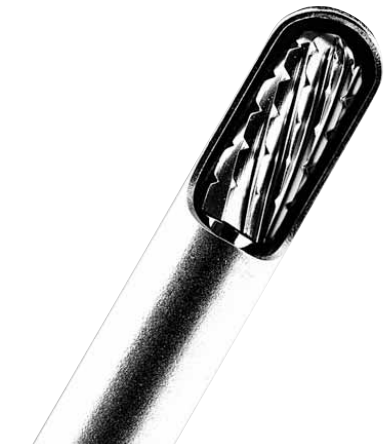

Ideal for less aggressive removal of hard bone
Ideal for rhinoplasty

Products not shown at actual size.
All products may not be available in all markets.

E9005 ENT Shaver Blades

Indications for Use: Sinus Surgery



Ideal for aggressive removal of hard bone and cartilage



Ideal for less aggressive removal of hard bone and cartilage



Ideal for less aggressive removal of hard bone and cartilage

Products not shown at actual size.
All products may not be available in all markets.

Rhinotec® Spherical Bur, Hooded

Cat. No.

4.5mm, Hooded, 10.8cm Working Length, 6/Box N9380

3.5mm, Hooded, 7.6cm Working Length, 6/Box C9912

2.9mm, Hooded, 7.6cm Working Length, 6/ Box C9911

Rhinotec® Spherical Bur, Unhooded

3.5mm, Hooded, 7.6cm Working Length, 6/Box N9382

Rhinotec Spherical Diamond Bur, Hooded

3.5mm, Hooded, 10.8cm Working Length, 6/Box N9385

* These burs may be used with multiple bur guard options to change the working length of the bur.

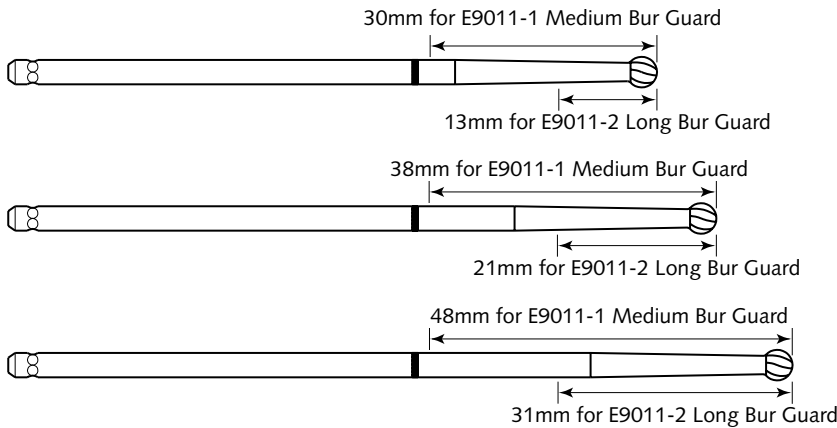

E9010 Bur Guard No.	Round Fluted						
	Flutes (mm)	4	4	6	6	6	8
Diameter (mm)		0.5	0.7	1.0	1.5	2.0	2.5
E9011-1 or E9011-2			E8007	E8010	E8015	E8020	E8025
E9011-1 or E9011-2		E8105		E8110	E8115	E8120	E8125
E9011-1 or E9011-2		E8205	E8207	E8210	E8215	E8220	E8225

Bur Guard No.	LSO Round Fluted				
	Flutes (mm)	8	8	8	10
Diameter (mm)		3.0	4.0	5.0	6.5
E9011-1 or E9011-2		E8030LSO	E8040LSO	E8050LSO	E8065LSO
E9011-1 or E9011-2		E8130LSO	E8140LSO	E8150LSO	E8165LSO
E9011-1 or E9011-2		E8230LSO	E8240LSO	E8250LSO	E8265LSO

E9010 Bur Guard No.	Fine Round Diamond										
	Diameter (mm)	0.5	0.7	1.0	1.5	2.0	2.5	3.0	4.0	5.0	6.0
E9011-1 or E9011-2									E6040		
E9011-1 or E9011-2		E6105		E6110	E6115	E6120	E6125	E6130	E6140	E6150	E6160
E9011-1 or E9011-2		E6205	E6207	E6210	E6215	E6220	E6225	E6230	E6240	E6250	

E9010 Bur Guard No.	Coarse Round Diamond									
	Diameter (mm)	1.0	1.5	2.0	2.5	3.0	4.0	5.0	6.0	7.0
E9011-1 or E9011-2				E5120		E5160	E5140	E5150	E5130	E5170
E9011-1 or E9011-2		E5210	E5215	E5220	E5225+	E5230	E5240	E5050		

Products shown at actual size.
All products may not be available in all markets.



E Burs

Indications for Use: Otology, Spine and Neuro

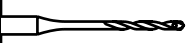
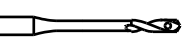
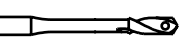

* These burs may be used with multiple bur guard options to change the working length of the bur.

	Wirepass burs			
	diameter (mm)	1	1.5	2
E9010 Bur Guard No	length	38	38	38
E9011-1 or E9011-2		E4110	E4115	E4120

	Neuro Burs			
	Flutes (mm)	1	2	2
	Diameter (mm)	1.8	2.2	3.0
E9010 Bur Guard No.	Bur Head Length (mm)	11.0	16.0	25.0
E9011-7 or 7020-017		7021-713		
E9011-8 or 7020-018			7021-815	
7020-019				7021-917

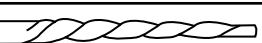

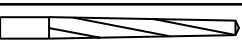

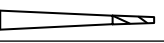
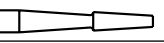



	Helical Bur for E9010 Drill	
E9010 Bur Guard No.	Bur Head Length (mm)	25
E9011-9, E9011-2 and 7020-012		7021-960





	E9010 Lindemann Bur	
	Diameter (mm)	1.6
E9010 Bur Guard No.	Bur Head Length (mm)	31.0
E9011-1		E4217







	E9010 Side Cutting Burs		
	Diameter (mm)	0.8	2.0
E9010 Bur Guard No.	Bur Head Length (mm)	4.9	7.5
E9011-1		E4208	E4220

Products shown at actual size.

All products may not be available in all markets.

UltraPower Bur Guard No.	Round Fluted									
	Flutes (mm)	4	6	6	6	8	8	8	8	8
UltraPower Bur Guard No.	Diameter (mm)	0.5	1.0	1.5	2.0	2.5	3.0	4.0	5.0	6.0
7020-010					7021-024	7021-025	7021-026	7021-027	7021-028	7021-029
7020-011			7021-122	7021-123	7021-124	7021-125	7021-126	7021-127	7021-128	7021-129
7020-012		7021-220	7021-222	7021-223	7021-224	7021-225	7021-226	7021-227	7021-228	7021-229
7020-013			7021-322	7021-323	7021-324	7021-325	7021-326	7021-327	7021-328	7021-329
7020-014							7021-426	7021-427	7021-428	7021-429
7020-015							7021-526		7021-528	7021-529

UltraPower Bur Guard No.	Round Fluted					
	Flutes (mm)	10	10	10	10	10
UltraPower Bur Guard No.	Diameter (mm)	6.5	7.5	8.0	9.0	10.0
7020-010		7021-030	7021-031	7021-034	7021-032	7021-033
7020-011		7021-130	7021-131	7021-134	7021-132	7021-133
7020-012		7021-230	7021-231		7021-232	7021-233
7020-013			7021-331		7021-332	7021-333
7020-014			7021-431		7021-432	7021-433
7020-015			7021-531		7021-532	7021-533
7020-016			7021-631		7021-632	7021-633







UltraPower Bur Guard No.	Fine Round Diamond							
	Diameter (mm)	1.0	2.0	3.0	4.0	5.0	6.0	7.0
7020-010			7021-062	7021-063	7021-064	7021-065	7021-066	7021-067
7020-011		7021-161	7021-162	7021-163	7021-164	7021-165	7021-166	7021-167
7020-012		7021-261	7021-262	7021-263	7021-264	7021-265	7021-266	7021-267
7020-013		7021-361	7021-362	7021-363	7021-364	7021-365	7021-366	7021-367





Products shown at actual size.
All products may not be available in all markets.

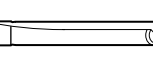
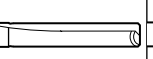
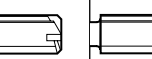
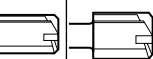

UltraPower® Burs

Indications for Use: Otology
(Round Burs Only), Spine and Neuro

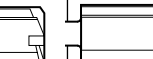
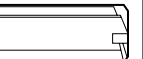





	Coarse Round Diamond							
UltraPower Bur Guard No.	Diameter (mm)	1.0	2.0	3.0	4.0	5.0	6.0	7.0
7020-010					7021-074	7021-075		7021-077
7020-011		7021-171	7021-172	7021-173	7021-174	7021-175	7021-176	7021-177
7020-012		7021-271	7021-272	7021-273	7021-274	7021-275	7021-276	7021-277
7020-013		7021-371	7021-372	7021-373	7021-374	7021-375	7021-376	7021-377
7020-014					7021-474			



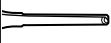

	Side Cutting Burs								
	Flutes (mm)	2	2	8	8	8	8	8	8
	Diameter (mm)	3.0	3.0	5.0	5.0	6.0	7.5	7.5	7.5
UltraPower Bur Guard No.	Bur Head Length (mm)	20.0	36.0	8.0	17.0	8.0	5.0	9.0	28.0
7020-011				7021-102				7021-106	
7020-012		7021-201		7021-202		7021-204		7021-206	7021-207
7020-013				7021-302	7021-303	7021-304	7021-305		
7020-014								7021-406	7021-427
7020-015								7021-506	

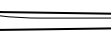
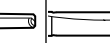
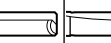
	Side Cutting Burs			
	Flutes (mm)	8	8	12
	Diameter (mm)	9.0	9.0	10.5
UltraPower Bur Guard No.	Bur Head Length (mm)	5.0	9.0	11.0
7020-011			7021-109	
7020-012			7021-209	7021-210
7020-013			7021-309	7021-310
7020-014		7021-408	7021-409	
7020-015			7021-509	7021-510
7020-016				7021-610

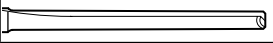
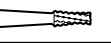
Products shown at actual size.
All products may not be available in all markets.

Ultrapower Bur Guard No.	Side Cutting Burs									
	Flutes (mm)	1	1	1	2	2	2	2	2	2
	Diameter (mm)	1.5	1.8	2.0	1.2	2.2	2.2	2.2	3.0	3.0
Ultrapower Bur Guard No.	Bur Head Length (mm)	8.0	11.0	16.0	6.0	16.0	23.0	20.0	25.0	
7020-010		7021-012	7021-013		7021-043	7021-015				
7020-011		7021-112	7021-113	7021-114	7021-143	7021-115	7021-116			
7020-012		7021-212	7021-713	7021-214	7021-243	7021-815				7021-917
7020-013				7021-314		7021-315		7021-301		

Ultrapower Bur Guard No.	Side Cutting Burs		
	Flutes (mm)	2	6
	Diameter (mm)	3.0	1.5
Ultrapower Bur Guard No.	Bur Head Length (mm)	36.0	4.9
7020-011			7021-119
7020-012		7021-218	
7020-013		7021-318	

Ultrapower Bur Guard No.	Fluted Cylindrical Burs				
	Flutes (mm)	2	2	2	2
	Diameter (mm)	1.8	1.8	2.2	3.0
7020-010				7021-036	7021-037
7020-011				7021-136	7021-137
7020-012			7021-235	7021-236	7021-237
7020-013		7021-338	7021-335	7021-336	7021-337
7020-014					7021-437





Products shown at actual size.
All products may not be available in all markets.

UltraPower® Burs

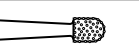
Indications for Use: Otology
(Round Burs Only), Spine and Neuro



		Fine Diamond Cylindrical Burs	
Ultrapower Bur Guard No.	Diameter (mm)		
7020-012		1.9	3.0
7020-013		7021-378	7021-379

		Fluted Acorn Burs			
					
		Flutes (mm)			
		8			
Ultrapower Bur Guard No.	Diameter (mm)	5.0	6.0	7.5	9.0
7020-010			7021-081		7021-083
7020-011			7021-181	7021-182	7021-183
7020-012		7021-280	7021-281	7021-282	7021-283
7020-013		7021-380	7021-381	7021-382	7021-383
7020-014				7021-482	7021-483
7020-015			7021-581		7021-583
7020-016			7021-681		7021-683

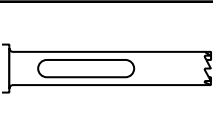
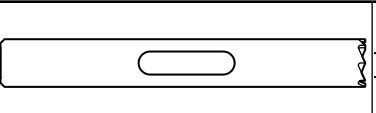
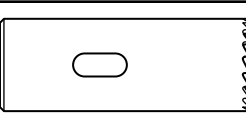
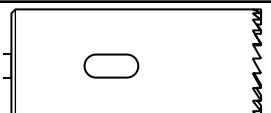
		Trephine Burs			
					
Ultrapower Bur Guard No.	Diameter (mm)	3.2	5.3	10.7	13.5
7020-010			7021-051		
7020-012		7021-250		7021-252	7021-253

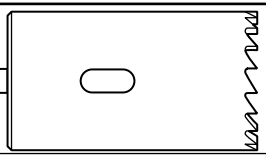

		Trephine Burs
		
Ultrapower Bur Guard No.	Diameter (mm)	16.8
7020-012		7021-255



Products shown at actual size.

All products may not be available in all markets.

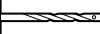
UltraPower® Burs



Indications for Use: Otolaryngology
(Round Burs Only), Spine and Neuro

	Wire Pass Burs			
	Flutes (mm)	2	2	2
UltraPower Bur Guard No.	Diameter (mm)	1.0	1.5	2.0
7020-010		7021-040	7021-041	7021-042
7020-011		7021-140	7021-141	7021-142

	Oval Fluted Burs		
	Flutes (mm)	8	8
	Diameter (mm)	4.0	5.5
UltraPower Bur Guard No.	Bur Head Length (mm)	8.0	10.0
7020-010		7021-095	7021-096
7020-011		7021-195	7021-196
7020-012		7021-295	7021-296
7020-013		7021-395	7021-396

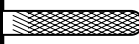
	Fluted Frustrum Bur	
	Flutes (mm)	8
UltraPower Bur Guard No.	Diameter (mm)	6.5
7020-013		7021-391

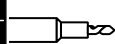
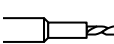
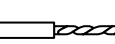
	Carbide Metal Cutting Burs	
	Diameter (mm)	3.2
UltraPower Bur Guard No.	Bur Head Length (mm)	15.2
7020-010		7021-094
7021-012		7021-294

	Wire Pass Burs - Depth Limiting				
	Diameter (mm)	1.1	1.1	1.1	1.5
UltraPower Bur Guard No.	Depth (mm)	3.5	5.0	9.0	7.0
7020-011		7021-141-35	7021-141-50	7021-141-90	7021-145-70

	Carbide Metal Cutting Burs	
	Flutes (mm)	8
	Diameter (mm)	6.0
UltraPower Bur Guard No.	Bur Head Length (mm)	4.0
7020-012		7021-297

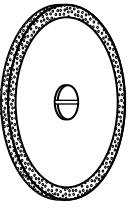
	Fine Diamond Wheels for Metal Cutting	
UltraPower Bur Guard No.	Diameter (mm)	25.4
7020-010		7021-092
7021-012		7021-292
7021-013		7021-392
7021-014		7021-492

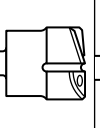
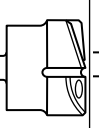
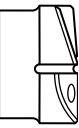
	End Cutting Burs			
	Flutes (mm)	4	4	4
UltraPower Bur Guard No.	Diameter (mm)	10.7	13.5	16.8
7020-012		7021-256	7021-257	7021-258

* Not C.E. Marked
Products shown at actual size.
All products may not be available in all markets.

Osteon Burs

Indications for use: Otolary



Working Length (mm)	Fluted Round Burs											
	Flutes (mm)	4	4	6	6	6	6	8	8	8	10	10
Diameter (mm)	0.5	0.7	1.0	1.5	2.0	2.5	2.5	3.0	4.0	5.0	6.5	
30			5056-173	5056-174	5056-177	5056-178	5056-179		5056-116	5056-119	5056-118	5056-117
38									5056-128	5056-127	5056-126	5056-125
48		5056-166	5056-165	5056-164	5056-140	5056-142		5056-149	5056-146	5056-145	5056-144	

Working Length (mm)	Fine Diamond Round Burs									
	Diameter (mm)	0.5	0.7	1.0	1.5	2.0	3.0	4.0	5.0	6.0
30								5056-168	5056-147	5056-167
38								5056-148	5056-150	
48		5056-161	5056-160	5056-158	5056-163	5056-162	5056-159	5056-152		

Working Length (mm)	Coarse Diamond Round Burs							
	Diameter (mm)	1.0	1.5	2.0	3.0	4.0	5.0	6.0
48		5056-958	5056-963	5056-962	5056-959	5056-952	5056-950	5056-967

Working Length (mm)	Deep Access Burs					
	Flutes (mm)	10	12	6		
Diameter (mm)	3.0	4.0	5.5	3.0	4.0	
90		5056-170	5056-171		5056-175	5056-176
95				5056-172		









Working Length (mm)	Wire Pass Burs			
	Diameter (mm)	1.0	1.5	2.0
Bur Head Length (mm)	19.0	19.0	19.0	
38		5056-184	5056-185	5056-186

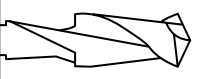

Working Length (mm)	80 Grit Dermabrasion Burs				
	Diameter (mm)	4.0	7.0	12.0	10.0
Bur Head Length (mm)	15.0	15.0	15.0	15.0	
30		5056-080	5056-081	5056-082	5056-083

Products shown at actual size.
All products may not be available in all markets.

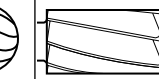
Cebotome® Burs and Metal Cutting Accessories

Indication for Use: Large Bone Revisions Surgery

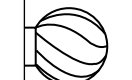
Cebotome® Burs								
Flutes (mm)	2	2	2	10	10	10	6	6
Diameter (mm)	5	6	7	7	8	9	8.5	10
	5052-181	5052-182	5052-183	5052-184	5052-185	5052-186	5052-187	5052-188

Cebotome Burs				
Flutes (mm)	6	10	6	8
Diameter (mm)	5	10	7	8.5
	5052-189	5052-190	5052-191	5052-192

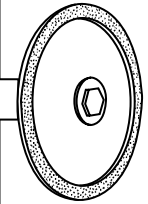
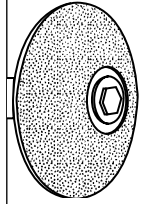
Cebotome Metal Cutting Wheels		
Grit (mm)	150	150
Diameter (mm)	25.4	25.4
	5052-125	5052-126

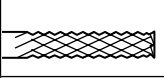
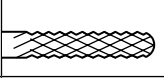
Cebotome Diamond Metal Cutting Burs		
Diameter (mm)	3.2	3.2
Diamond	Flat	Round
	5052-144	5052-145

Products shown at actual size.
All products may not be available in all markets.

Sternum Saw Blades

Indication for Use: Primary and Repeat Sternotomy



Sternum Saw Blades

Cat. No.	Width (mm)	Length (mm)	Non-sterile
5059-531	10.0	54.0	
5059-031	10.0	54.0	
5059-031-01	10.0	54.0	50 Pack
5059-532	10.0	35.0	
5059-032	10.0	35.0	
5059-032-01	10.0	35.0	50 Pack
5059-233*		34.0	
5059-235**		32.0	

* For use with Sarns Sternum Saw

** For use with Stryer Sternum Saw

5059-531



5059-531-01

5059-032



5059-032-01

5059-233

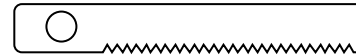

5059-235

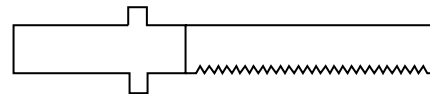

Repeat Sternotomy Blades

Cat. No.	Width (mm)	Length (mm)	View Illustration
1384-175	52.0	19.0	Page 67
1384-176	63.0	19.0	Page 67
5023-187	50.0	24.0	Page 67
5023-188	63.0	24.0	Page 67
5023-178	44.6	40.0	Page 67
5023-179	54.6	40.0	Page 67
5023-180	65.8	40.0	Page 68
5059-278	44.6	40.0	Page 68
5059-279	54.6	40.0	Page 68
5059-280	65.8	40.0	Page 68
5071-125	50.0	19.0	Page 68
5071-126	63.0	19.0	Page 68
5071-228	44.5	40.0	Page 68
5071-229	54.5	40.0	Page 68
5071-230	66.0	40.0	Page 68

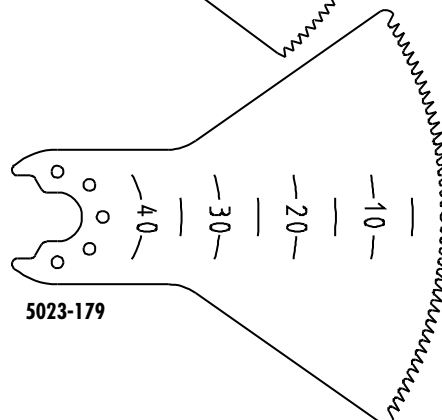
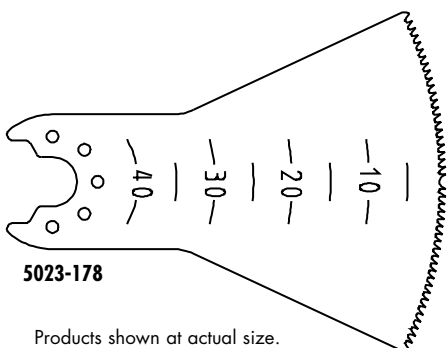
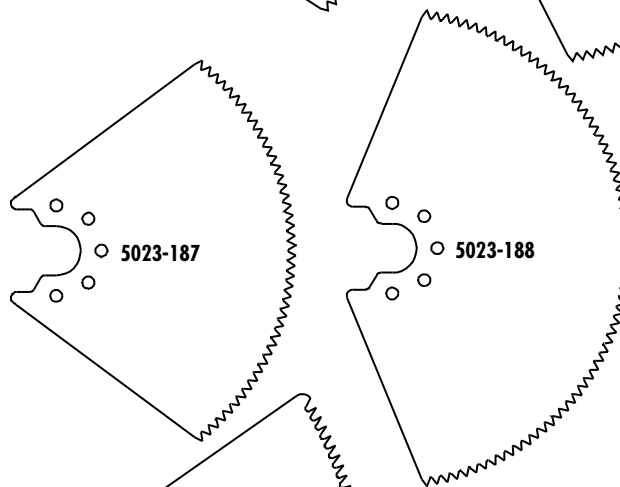
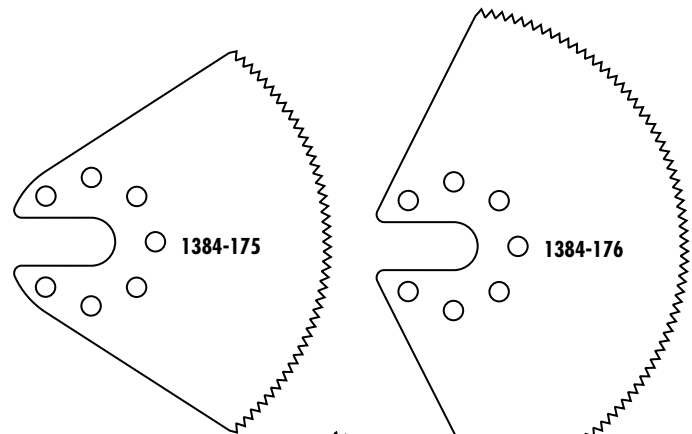

Products shown at actual size.
All products may not be available in all markets.

Sternum Saw Blades

Indications for Use: Primary and Repeat Sternotomy

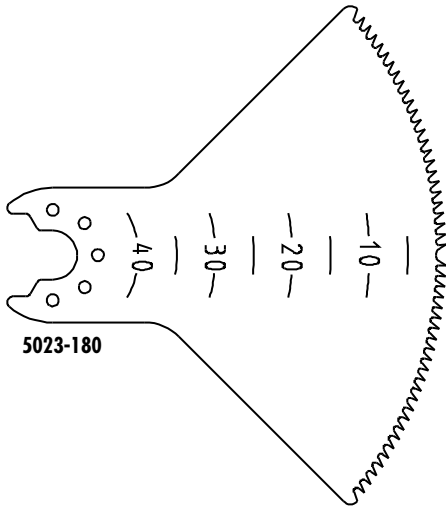

5023-180

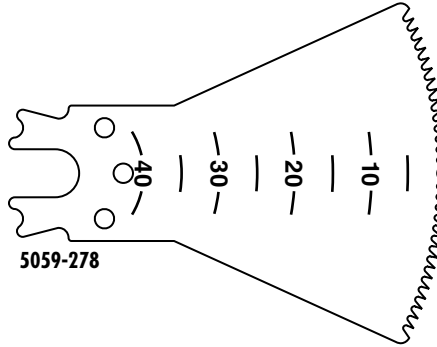

5059-278

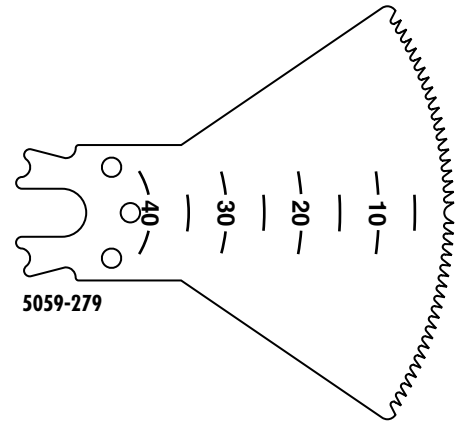

5059-279

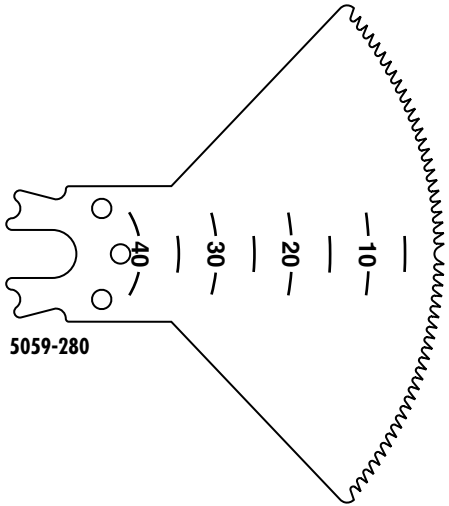

5059-280

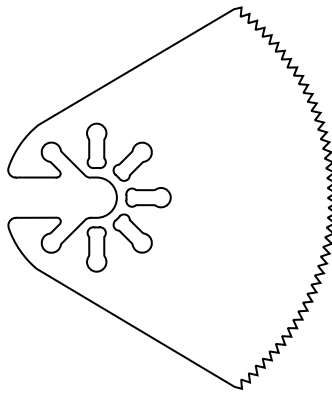

5071-125

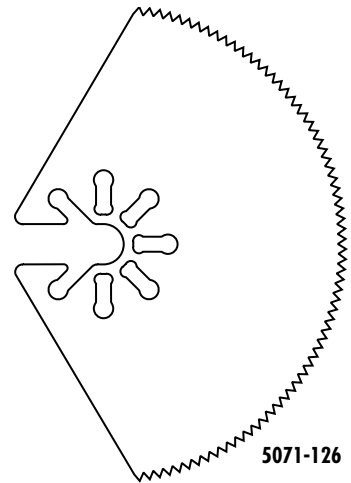

5071-126

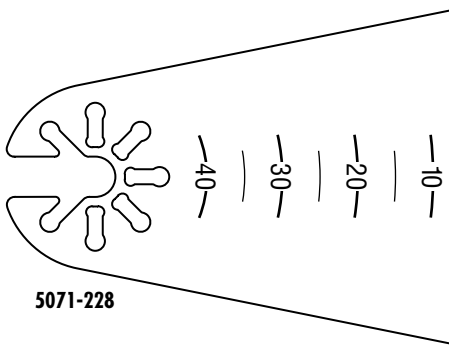

5071-228

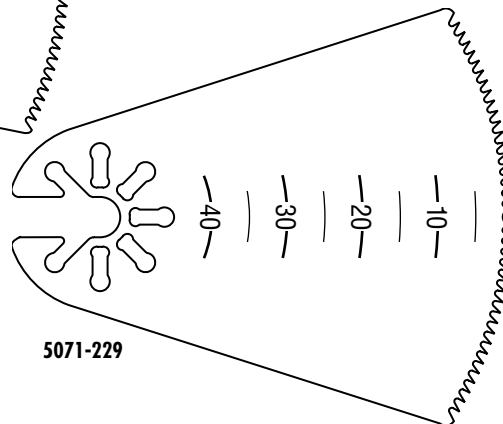

5071-229

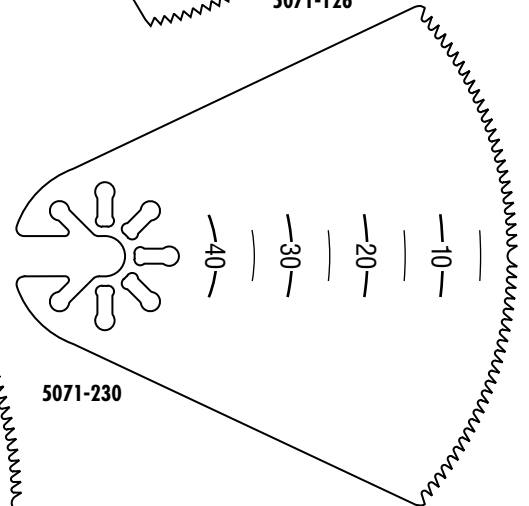

5071-230

Products shown at actual size.

All products may not be available in all markets.

HALL® SURGICAL
**POWERED
INSTRUMENTS
INDEX**

Cat. No.	Description	Page No.
1365-005	HEX WRENCH	16
1365-016	HALL® LUBRICANT	8
1375-003	BUR CHANGER	14
1375-011	BUR GUARD, LONG	14, 51 – 53
1375-012	BUR GUARD, MEDIUM	14, 24 , 51 – 53
1375-015	BUR BRUSH	23, 24, 26, 27
1375-020	LAMINECTOMY BUR GUARD	14 – 52
1375-021	RHINOPLASTY BUR GUARD	14 – 51
1375-023	BUR GUARD, CLOWARD X-LONG	14, 51 – 53
1375-028	MICRO 100™ FOOT CONTROL	8
1375-032	ANGLE ATTACHMENT 20D NSK	14, 51, 53
1375-033	ANGLE ATTACHMENT X-LONG 20D NSK	14, 53
1375-034	ANGLE ATTACH 70D W/DENTAL NSK	14
1375-035	ANGLE ATTACHMENT, 70D CONTRA ANGLE NS	14, 51, 52
1375-036	ANGLE ATTACHMENT 90D NSK	14, 51, 52
1375-037	ATTACHMENT LUBRICANT	8
1375-040	Y CONNECTOR	8
1375-112	BUR GUARD SLEEVE SURGAIRTOME II® -1 EACH IS A BOX OF 30	16
1384-042	AUTOCLAVE CASE, LARGE	23
1384-175	ST OSCIL BLADE 50 X 19 X .4MM	68
1384-176	ST OSCIL BLADE 63 X 19 X .4MM	68
1387-022	TISSUE RETRACTOR GUARD	14, 51, 52
2075-017	PRESSURE TESTER	8
5020-053	MICROCHOICE® FOOT CONTROL	7
5020-054	MICROCHOICE POLE MOUNT	7
5020-160	BUR GUARD SLEEVE MICROCHOICE 30/BX	16
5023-055	25 X 6.3 X 3.8 STRAIGHT	48
5023-056	25 X 6.3 X 3.8 MEDIAL 25 DEGREES	48
5023-057	25 X 6.3 X 3.8 LATERAL 70 DEGREES	48
5023-101	STERILE MC INTRA-ORAL BLD 11.5 X 7 X .4MM	49
5023-102	STERILE MC INTRA-ORAL BLD 11.5 X 12 X .4MM	49
5023-103	STERILE MC INTRA-ORAL BLD 9 X 12 X .4MM	49
5023-104	STERILE MC INTRA-ORAL BLD 5 X 12 X .4MM	49
5023-118	ST SAG BLDE FINE 9.5 X 25.5 X 0.4MM 5 EA	46
5023-128	ST SAG BLDE FN 70D 9.5 X 7.5 X 0.6MM 5 EA	47
5023-129	ST SAG BLD FN 70D 9.5 X 13.5 X 0.6MM 5 EA	47
5023-130	ST SAG BLDE CRS 19.5 X 25.5 X 0.4MM 5 EA	46
5023-131	ST SAG BLDE CRS 19.5 X 41.0 X 0.4MM 5 EA	46
5023-132	ST SAG BLDE CRS 5.5 X 25.5 X 0.4MM 5 EA	46
5023-133	ST SAG BLDE CRS 14.0 X 41.0 X 0.4MM 5 EA	46
5023-134	MICRO SAG SAW BLADE FINE 5.5 X 9 X .6MM 5 EA	47
5023-135	ST SAG BLDE CRS 45 5.5 X 18 X 0.6MM 5 EA	47
5023-136	MICRO SAG SAW BLD FINE 14 X 15.5 X .6MM 5 EA	47
5023-137	ST SAG BLDE CRS 14 X 25.5 X 0.4MM 5 EA	46
5023-138	ST SAG BLDE FINE 9.5 X 25.5 X 0.4MM 5 EA	46
5023-139	ST SAG BLDE FINE 4.5 X 25.5 X 0.4MM 5 EA	46
5023-140	ST SAG BLDE FINE 9.5 X 41 X 0.4MM 5 EA	46
5023-141	ST SAG BLDE FINE 6 X 34 X 0.4MM 5 EA	46
5023-142	ST SAG BLDE FINE 4 X 34 X 0.4MM 5 EA	46
5023-143	ST SAG BLDE CRS 9.5 X 25.5 X 0.4MM 5 EA	46
5023-144	ST SAG BLADE 5.5 X 18.5 X .4MM 5 EA	46
5023-160	ST OSC BLDE FINE 5.5 X 12 X 0.4MM 5 EA	49
5023-161	ST OSC BLDE FINE 10 X 12 X 0.4MM 5 EA	49
5023-162	ST OSC BLDE FINE 5.5 X 18.5 X 0.4MM 5 EA	49
5023-163	ST OSC BLDE FINE 10 X 18.5 X 0.4MM 5 EA	49
5023-164	ST OSC BLDE FINE 5.5 X 28.5 X 0.4MM 5 EA	49
5023-165	ST OSC BLDE RADSD 10 X 28.5 X 0.4MM 5 EA	49
5023-166	ST OSC BLDE FINE 18.5 X 28.5 X 0.4MM 5 EA	49
5023-167	ST OSC BLDE FINE 20 5.5 X 13 X 0.4MM 5 EA	49

Numerical Index



Cat. No.	Description	Page No.
5023-168	ST OSC BLDE FINE 20 10 X 13 X 0.4MM 5 EA	49
5023-169	ST OSC BLDE FINE 10 X 35 X 0.4MM 5 EA	49
5023-170	ST OSC BLDE CRES 9 X 12 X 0.4	49
5023-171	ST OSC BLDE CRES 13.5 X 25.5 X 0.4	49
5023-172	ST OSC BLDE CRES 18 X 32 X 0.4	49
5023-176	ST OSC BLDE CRES 13.5 X 32 X 0.4	49
5023-178	REPEAT STERNOTOMY BLADE 44.6MM 5 EA	68
5023-179	ST REPEAT STERN BLADE 54.6MM 5 EA	68
5023-180	REPEAT STERNOTOMY BLADE 65.8MM 5 EA	69
5023-182	STERILE ACL BLD 19 X 41 X .4MM 5 EA	47
5023-183	STERILE ACL BLD 9.5 X 25.5 X .4MM 5 EA	47
5023-184	STERILE ACL BLD 9.5 X 41 X .4MM 5 EA	47
5023-185	ST ACL BLADE 6.5 X 30 X .6MM 5 EA	47
5023-186	ST ACL BLADE 8.5 X 38 X .4MM	47
5023-187	ST REPEAT STERN BLD 50 X 24 X .4MM	68
5023-188	ST REPEAT STERN BLADE 63 X 24 X .4MM	68
5023-244	MICROBLADE SAG 4 X 6 X .4MM FLAT FINE 5 EA	46
5023-258	ST OSC BLDE RADSD 10 X 9 X 0.4MM 5 EA	49
5023-259	ST OSC BLDE RADSD 10 X 13.5 X 0.4MM 5 EA	49
5023-405	STERILE GRAFT HARVESTING BLADE 5 X 20MM	48
5023-406	STERILE GRAFT HARVESTING BLADE 6 X 20MM	48
5023-407	STERILE GRAFT HARVESTING BLADE 7 X 20MM	48
5023-408	STERILE GRAFT HARVESTING BLADE 8 X 20MM	48
5023-409	STERILE GRAFT HARVESTING BLADE 9 X 20MM	48
5023-410	STERILE GRAFT HARVESTING BLADE 10 X 20MM	48
5023-411	STERILE GRAFT HARVESTING BLADE 11 X 20MM	48
5023-412	STERILE GRAFT HARVESTING BLADE 12 X 20MM	48
5023-413	STERILE GRAFT HARVESTING BLADE 13 X 20MM	48
5037-033	DISPOSABLE FILTERS 1000 PER BOX	23
5038-001	OSTEON STRAIGHT HANDPIECE W/O HOSE	19, 26, 27
5038-002	OSTEON ANGLED HANDPIECE W/O HOSE	19, 26, 27
5038-004	OSTEON FOOT CONTROL WITH HOSE	19, 26, 27
5038-005	OSTEON HOSE	19, 26, 27
5038-009	OSTEON BUR RACK	19, 26, 27
5038-600	OSTEON IRRIGATION TUBING 5/BOX	19
5039-003	AC POWER CORD	7
5040-158	REUSABLE 20D ANGLE BUR TIP	14
5040-159	REUSABLE X-LONG 20D BUR TIP	14
5040-180	IRRIGATION BAG SUPPORT ROD	7
5044-145	MICRO SAGL BLADE 10 X 18.5 X .4MM FINE 5 EA	46
5044-999-52	1/4 IN. JACOBS CHUCK KEY REPLACEMENT	13
5044-999-53	5/32 IN. JACOBS CHUCK KEY REPLACEMENT	13
5050-041	C-WIRE™ - .028 IN. SPADE TIP	54
5050-042	C-WIRE - .035 IN. SPADE TIP	54
5050-043	C-WIRE - .045 IN. SPADE TIP	54
5050-044	C-WIRE - .062 IN. SPADE TIP	54
5050-046	C-WIRE - .028 IN. TROCAR TIP	54
5050-047	C-WIRE - .035 IN. TROCAR TIP	54
5050-048	C-WIRE - .045 IN. TROCAR TIP	54
5050-049	C-WIRE - .062 IN. TROCAR TIP	54
5052-010	UNIVERSAL HOSE, 10'	8, 21, 24, 25, 27
5052-012	AUTOCLAVE CASE	19, 23, 24
5052-016	UNIVERSAL HOSE, 15'	8
5052-018	EXTENSION HOSE, 10'	8
5052-029	EXTENSION HOSE, 10' WITH DISS CONNECTOR	8
5052-030	EXTENSION HOSE, 15'	8
5052-031	EXTENSION HOSE, 20'	8
5052-041	CEBOTOME® REVISION DRILL W/O HOSE	21, 27
5052-042	CEBOTOME SHORT BUR EXTENSION	21, 27

Cat. No.	Description	Page No.
5052-046	CEBOTOME® WRENCH	21, 27
5052-048	CEBOTOME BUR EXTENSION, MEDIUM THIN	21, 27
5052-049	CEBOTOME BUR EXTENSION, LONG THIN	21
5052-125	CEBOTOME METAL CUTTING WHEEL	27, 67
5052-126	CEBOTOME METAL TRIMMING WHEEL	27, 67
5052-129	CEBOTOME METAL CUTTING WHEEL WRENCH	27
5052-135	STER RPLCMNT BLADE/STRYKER RECIP 5 EA	45
5052-142	CEBOTOME METAL CUTTING BUR EXTENSION	21, 27
5052-143	CEBOTOME METAL CUTTING BUR WRENCH	21, 27
5052-144	ST CEBOTOME METAL CUTTING BUR SIDE/FLAT	27, 67
5052-145	ST CEBOTOME METAL CUTTING BUR SIDE/ROUND	27, 67
5052-173	ST RECIPROCATOR BLADE 12.5 X 73.5MM 5 EA	44
5052-179	RECIPROCATOR BLADE, COATED, 12.5 X 76.0MM 5 EA	44
5052-181	ST CEBOTOME BUR, 5MM SIDE CUTTING	67
5052-182	ST CEBOTOME BUR, 6MM SIDE CUTTING	67
5052-183	ST CEBOTOME BUR, 7MM SIDE CUTTING	67
5052-184	ST CEBOTOME BUR, 7MM ROUND	67
5052-185	ST CEBOTOME BUR, 8MM ROUND	67
5052-186	ST CEBOTOME BUR, 9MM ROUND	67
5052-187	ST CEBOTOME BUR, 8.5MM BARREL	67
5052-188	ST CEBOTOME BUR, 10.0MM BARREL	67
5052-189	ST CEBOTOME BUR, 5.0MM ROUND	67
5052-190	ST CEBOTOME BUR, 10.0MM ROUND	67
5052-191	ST CEBOTOME BUR, 7.0MM CONTOURED	67
5052-192	ST CEBOTOME BUR, 8.5MM CONTOURED	67
5052-258	RECIPROCATOR BLADE, 12.5 X 89MM 5 EA	44
5052-259	RECIPROCATOR BLADE 9.4 X 54.5MM 5 EA	44
5052-260	RECIPROCATOR BLADE 12.5 X 38.0MM 5 EA	44
5052-261	RECIPROCATOR BLADE 12.5 X 89.0MM 5 EA	44
5052-276	RECIPROCATOR BLADE, 13 X 48MM	44
5052-281	LARGE BONE RECIP BLD, 9.4 X 54.5 X 1.5MM 5 EA	44
5052-291	LGBN BLD RECIP, COATED, 12.5 X 76 X 1.2MM	44
5052-332	ST REPL BLADE/STRYKER RECIP 76.0MM 5 EA	45
5052-333	ST REPL BLADE/STRYKER RECIP 76.0MM 5 EA	45
5052-334	ST REPL BLADE/STRYKER RECIP 12.5MM 5 EA	45
5053-009	MICRO 100™ DRILL W/O HOSE	16
5053-010	MICRO 100 RECIPROCATOR SAW W/O HOSE	16
5053-011	MICRO 100 SAGITTAL SAW W/O HOSE	16
5053-012	MICRO 100 OSCILLATOR SAW W/O HOSE	16
5053-013	MICRO 100 WIREDRIVER W/O HOSE	16
5053-019	WIREDRIVER 100 CHUCK ADAPTOR	16
5053-022	MICRO 100 OSCILLATOR SAW,X-LONG W/O HOSE	16
5053-050	MICRO RECIPROCATING SAW BLADE, 7 X 5MM	50
5053-051	MICRO RECIPROCATING SAW BLADE, 17 X 4MM	50
5053-052	MICRO RECIPROCATING SAW BLADE, 23 X 5MM	50
5053-053	MICRO RECIPROCATING SAW BLADE, 25 X 7MM	50
5053-054	MICRO RECIPROCATING SAW BLADE, 25 X 8MM	50
5053-074	THROTTLE CLIP	16
5053-080	MICRO RECIP RASP SMALL STRAIGHT STERILE	50
5053-081	MICRO RECIP RASP LARGE STRAIGHT STERILE	50
5053-082	MICRO RECIP RASP SMALL CROSS CUT STERILE	50
5053-083	MICRO RECIP RASP LARGE CROSS CUT STERILE	50
5053-084	MICRO RECIP RASP SMALL INTRAMED STERILE	50
5053-085	MICRO RECIP RASP LARGE INTRAMED STERILE	50
5053-122	ST MICRO RECIP BLADE 25.5 X 25MM	50
5053-123	WIREDRIVER WIRE GUARD	16
5053-124	WIREDRIVER BRUSH	23
5053-126	ST MICRO RECIP BLADE 28.0 X 0.6MM	50
5053-220	ST MICRO RECIPROCTING SAW BLADES, 25.5MM	50

Numerical Index



Cat. No.	Description	Page No.
5053-221	ST MICRO RECIPROCTING SAW BLADES, 38MM 5/BOX	50
5056-002	OTOTOME MOTOR WITH 10 FOOT HOSE	26
5056-003	OTOTOME FOOT CONTROL	19
5056-080	OSTEON BUR, DERMABRADER, DIAMOND, 4.0	66
5056-081	OSTEON BUR, DERMABRADER, DIAMOND, 7.0	66
5056-082	OSTEON BUR, DERMABRADER, DIAMOND, 12.0	66
5056-083	OSTEON BUR, DERMABRADER, DIAMOND, 10 X 3	66
5056-109	ST OSTEON BUR SET	19
5056-116	ST OSTEON BUR,CARBIDE ROUND, 3.0 X 30M	66
5056-117	ST OSTEON BUR, CARBIDE ROUND, 6.5 X 30M	26, 66
5056-118	ST OSTEON BUR, CARBIDE ROUND, 5.0 X 30M	26, 66
5056-119	ST OSTEON BUR, CARBIDE ROUND, 4.0 X 30M	26, 66
5056-125	ST OSTEON BUR, CARBIDE ROUND, 6.5 X 38M	66
5056-126	ST OSTEON BUR, CARBIDE ROUND, 5.0 X 38M	26, 66
5056-127	ST OSTEON BUR, CARBIDE ROUND, 4.0 X 38M	66
5056-128	ST OSTEON BUR CARBIDE ROUND, 3.0 X 38M	66
5056-140	ST OSTEON BUR STEEL, ROUND, 1.5 X 48M	26, 66
5056-142	ST OSTEON BUR STEEL ROUND, 2.0 X 48M	26, 66
5056-144	ST OSTEON BUR CARBIDE ROUND, 5.0 X 48M	66
5056-145	ST OSTEON BUR CARBIDE ROUND, 4.0 X 48M	26, 66
5056-146	ST OSTEON BUR CARBIDE ROUND, 3.0 X 48M	26, 66
5056-147	ST OSTEON BUR DIAMOND ROUND, 5.0 X 38M	66
5056-148	ST OSTEON BUR DIAMOND ROUND, 4.0 X 38M	66
5056-149	ST OSTEON BUR CARBIDE ROUND, 2.5 X 48.0MM	66
5056-150	ST OSTEON BUR DIAMOND ROUND, 5.0 X 48M	66
5056-152	ST OSTEON BUR DIAMOND ROUND, 4.0 X 48M	26, 66
5056-158	ST OSTEON BUR DIAMOND ROUND, 1.0 X 48M	26, 66
5056-159	ST OSTEON BUR DIAMOND ROUND, 3.0 X 48M	26, 66
5056-160	ST OSTEON BUR DIAMOND ROUND, 0.7 X 48M	66
5056-161	ST OSTOEN BUR DIAMOND ROUND, 0.5 X 48M	26, 66
5056-162	ST OSTEON BUR DIAMOND ROUND, 2.0 X 48M	26, 66
5056-163	ST OSTEON BUR DIAMOND ROUND, 1.5 X 48M	66
5056-164	ST OSTEON BUR STEEL ROUND, 1.0 X 48M	26, 66
5056-165	ST OSTEON BUR STEEL ROUND, 0.7 X 48M	66
5056-166	ST OSTEON BUR STEEL ROUND, 0.5 X 48M	26, 66
5056-167	ST OSTEON BUR DIAMOND ROUND, 6.0 X 38M	66
5056-168	ST OSTEON BUR DIAMOND ROUND, 4.0 X 30M	66
5056-170	ST OSTEON DP ACCESS BUR ROUND, 3.0 X 90.	66
5056-171	ST OSTEON DP ACCESS BUR ROUND, 4.0 X 90.	66
5056-172	ST OSTEON DP ACCESS BUR OVAL, 5.5 X 95.0	66
5056-173	ST OSTEON BUR STEEL ROUND, 0.7 X 30M	66
5056-174	ST OSTEON BUR STEEL ROUND, 1.0 X 30M	66
5056-175	ST OSTEON DEEP ACCESS BURRND DIAMOND 3.0	66
5056-176	ST OST DP ACCESS BUR RND DIAMOND 4.0	66
5056-177	ST OSTEON BUR STEEL ROUND, 1.5 X 30M	66
5056-178	OSTEON BUR. STEEL ROUND, 2.0 X 30M	66
5056-179	ST OSTEON BUR STEEL ROUND, 2.5 X 30M	66
5056-184	ST OSTEON BUR STEEL WIRE PASS, 1.0	66
5056-185	ST OSTEON BUR STEEL WIRE PASS, 1.5	66
5056-186	ST OSTEON BUR STEEL WIRE PASS, 2.0	66
5056-950	ST OST RND DMD CRS BUR 5.0 X 48	66
5056-952	ST OST RND DMD CRS BUR 4.0 X 48	66
5056-958	ST OST RND DMD CRS BUR 1.0 X 48	66
5056-959	ST OST RND DMD CRS BUR 3.0 X 48	66
5056-962	ST OST RND DMD CRS BUR 2.0 X 48	66
5056-963	ST OST RND DMD CRS BUR 1.5 X 48	66
5056-967	ST OST RND DMD CRS BUR 6.0 X 38	66
5057-040	REPEAT STERNOTOMY SAW W/O HOSE	20
5058-000	SURGAIRTOME TWO® KIT	16

Cat. No.	Description	Page No.
5058-001	SURGAIRTOME TWO® HANDPIECE W/O HOSE	16, 24
5059-005	STERNUM SAW HANDPIECE(PNEUM) W/O HOSE	20
5059-006	STERNUM SAW BLADE GUARD	20
5059-007	STERNUM SAW WRENCH	20
5059-011	EXTENDED STERNUM SAW BLADE GUARD	20
5059-031	STERNUM SAW BLADE NONSTERILE	68
5059-031-01	STERNUM SAW BLADE NONSTERILE 50 PACK	68
5059-032	NON-STERILE STERNUM SAW BLADE	68
5059-032-01	NON-STERILE BULK PACK STERNUM SAW BLADE	68
5059-233	ST REPL BLADE/SARNS STERNUM SAW 5 EA	68
5059-235	ST REPL BLADE/STRYKER STERNUM SAW 5 EA	68
5059-278	ST REPEAT STERNOTOMY BLADE 44.5MM 5 EA	68, 69
5059-279	ST REPEAT STERNOTOMY BLADE 54.6MM 5 EA	68, 69
5059-280	ST REPEAT STERNOTOMY BLADE 65.8MM 5 EA	68, 69
5059-531	ST EXTENDED STERNUM SAW BLADES 5 EA	68
5059-532	ST STERNUM SAW BLADES 10 X 35 X 0.66MM 5 EA	68
5071-105	ST GRAFT HARVESTING BLD 5 X 20	39
5071-106	ST GRAFT HARVESTING BLD 6 X 20	39
5071-107	ST GRAFT HARVESTING BLD 7 X 20	39
5071-108	ST GRAFT HARVESTING BLD 8 X 20	39
5071-109	ST GRAFT HARVESTING BLD 9 X 20	39
5071-110	ST GRAFT HARVESTING BLD 10 X 20	39
5071-111	ST GRAFT HARVESTING BLD 11 X 20	39
5071-112	ST GRAFT HARVESTING BLD 12 X 20	39
5071-113	ST GRAFT HARVESTING BLD 13 X 25	39
5071-120	STER OSC BLD 19.5 X 95 X 0.9MM 5 EA	29, 31
5071-121	STER OSC BLD 25.4 X 95 X 0.9MM 5 EA	29, 31
5071-123	STER OSC BLD 19.5 X 95 X 1.27MM 5 EA	29, 34
5071-124	STER OSC BLD 25.4 X 95 X 1.27MM 5 EA	29, 35
5071-125	ST OSCIL BLADE 50 X 19 X 0.4MM	68, 69
5071-126	ST OSCIL BLADE 63 X 19 X 0.4MM	68, 69
5071-127	ST OSCIL BLADE 8.5 X 38 X 0.4MM	39
5071-129	OSCBLD 19.5 X 105 X 1.27 X 1.27MM STERILE 5 EA	29, 35
5071-132	ST OSC BLD 19.5 X 41 X .4MM 5 EA	40
5071-133	ST OSC BLD 9.5 X 25 X .4MM 5 EA	39
5071-134	ST OSC BLD 9 X 41 X .4MM 5 EA	39
5071-135	ST OSC BLD 5 X 30 X .6MM 5 EA	39
5071-140	ST OSC BLD, COATED, 25.4 X 80 X 1.2MM 5 EA	40, 43
5071-141	ST OSC BLD, COATED, 19.5 X 80 X 1.2MM 5 EA	40, 43
5071-142	ST OSC BLD, COATED, 25.4 X 90 X 1.2MM 5 EA	40, 43
5071-143	ST OSC BLD, COATED, 25.4 X 90 X .8MM 5 EA	40, 42
5071-144	ST OSC BLD, COATED, 25.4 X 90 X 1.5MM 5 EA	29, 35
5071-145	ST OSC BLD 13 X 72 X 1.2MM 5 EA	40, 43
5071-146	ST OSCIL BLADE 25 X 90 X .9MM 5 EA	29, 31
5071-161	OSC BLADE 25.4 X 90 X 1.27MM 5 EA	29, 34
5071-163	ST OSC BLD 25.4 X 90 X 1.37MM 5 EA	29, 35
5071-166	ST OSCIL BLD, COATED, 32 X 64MM 5 EA	40, 41
5071-167	ST OSC BLD, COATED, 19.5 X 90 X 1.2MM 5 EA	29, 32
5071-174	ST OSC BLD 19.5 X 86 X .8MM 5 EA	40, 42
5071-175	ST OSC ABRASION BLADE	43
5071-177	ST OSCIL BLADE, COATED, 19.5MM 5 EA	40, 41
5071-178	ST OSCIL BLADE, COATED, 19.5MM 5 EA	40, 42
5071-180	STER OSC BLD 10 X 85 X 1.27MM 5 EA	29, 33
5071-181	STER OSC BLD 19.5 X 86 X 1.27MM 5 EA	29, 33
5071-184	STER OSC BLD 19.5 X 90 X 1.2MM 5 EA	29, 32
5071-185	STER OSC BLD 19.5 X 80 X 0.9MM 5 EA	29, 30
5071-186	STER OSC BLD 32 X 64 X 0.8MM 5 EA	40, 41
5071-187	STER OSC BLD 19.5 X 71 X 0.8MM 5 EA	40, 42
5071-188	STER OSC BLD 19.5 X 80 X 0.8MM 5 EA	40, 42

Numerical Index



Cat. No.	Description	Page No.
5071-195	ST OSCIL BLADE, COATED, 19.5MM 5 EA	29, 31
5071-196	STER OSC BLD 25.4 X 0.9 X 90MM 5 EA	29, 31
5071-201	ST BLD, COATED, NEXGEN, 19.5 X 86 X 1.27	29, 33
5071-228	STER REPT STERNTMY BLD, 44.5 X 4MM 5 EA	68, 69
5071-229	XTER REPT STERNTMY BLD, 54.5 X 4MM 5 EA	68
5071-230	STER REPEAT STERNTMY BLD, 66 X 40MM 5 EA	68, 69
5071-236	LG BN OSC 9.12 X 25.22 X 0.64, 0.64MM 5 EA	39
5071-246	OSC BLADE FINE 5.5 X 25.5 X 0.6MM 5 EA	39
5071-300	INTREX® BLADE 19.5 X 90 X 0.89, 5 EA	28
5071-301	INTREX BLADE 19.5 X 90 X 1.00, 5 EA	28
5071-302	INTREX BLADE 19.5 X 90 X 1.07, 5 EA	28
5071-303	INTREX BLADE 19.5 X 90 X 1.19, 5 EA	28
5071-304	INTREX BLADE 19.5 X 90 X 1.27, 5 EA	28
5071-305	INTREX BLADE 19.5 X 90 X 1.37, 5 EA	28
5071-306	INTREX BLADE 19.5 X 90 X 1.47, 5 EA	68, 69
5071-310	INTREX BLADE 25 X 9 X 90 X 0.89, 5 EA	28
5071-311	INTREX BLADE 25 X 9 X 90 X 1.00, 5 EA	28
5071-312	INTREX BLADE 25 X 9 X 90 X 1.07, 5 EA	28
5071-313	INTREX BLADE 25 X 9 X 90 X 1.19, 5 EA	28
5071-314	INTREX BLADE 25 X 9 X 90 X 1.27, 5 EA	28
5071-315	INTREX BLADE 25 X 9 X 90 X 1.37, 5 EA	28
5071-316	INTREX BLADE 25 X 9 X 90 X 1.47, 5 EA	28
5071-320	INTREX BLADE 25.0 X 90 X 0.89, 5 EA	28
5071-321	INTREX BLADE 25.0 X 90 X 1.00, 5 EA	28
5071-322	INTREX BLADE 25.0 X 90 X 1.07, 5 EA	28
5071-323	INTREX BLADE 25.0 X 90 X 1.19, 5 EA	28
5071-324	INTREX BLADE 25.0 X 90 X 1.27, 5 EA	28
5071-325	INTREX BLADE 25.0 X 90 X 1.37, 5 EA	28
5071-326	INTREX BLADE 2530 X 90 X 1.47, 5 EA	28
5071-330	INTREX BLADE 25.0 X 100 X 0.89, 5 EA	28
5071-331	INTREX BLADE 25.0 X 100 X 1.00, 5 EA	28
5071-332	INTREX BLADE 25.0 X 100 X 1.07, 5 EA	28
5071-333	INTREX BLADE 25.0 X 100 X 1.19, 5 EA	28
5071-334	INTREX BLADE 25.0 X 100 X 1.27, 5 EA	28
5071-335	INTREX BLADE 25.0 X 100 X 1.37, 5 EA	28
5071-336	INTREX BLADE 25.0 X 100 X 1.47, 5 EA	28
5071-340	INTREX BLADE 12.5 X 90 X 0.89, 5 EA	28
5071-341	INTREX BLADE 12.5 X 90 X 1.00, 5 EA	28
5071-342	INTREX BLADE 12.5 X 90 X 1.07, 5 EA	28
5071-343	INTREX BLADE 12.5 X 90 X 1.19, 5 EA	28
5071-344	INTREX BLADE 12.5 X 90 X 1.27, 5 EA	28
5071-345	INTREX BLADE 12.5 X 90 X 1.37, 5 EA	28
5071-346	INTREX BLADE 12.5 X 90 X 1.47, 5 EA	28
5071-350	INTREX BLADE 13 X 8 X 70 X 0.89, 5 EA	28
5071-351	INTREX BLADE 13 X 8 X 70 X 1.00, 5 EA	28
5071-352	INTREX BLADE 13 X 8 X 70 X 1.07, 5 EA	28
5071-353	INTREX BLADE 13 X 8 X 70 X 1.19, 5 EA	28
5071-354	INTREX BLADE 13 X 8 X 70 X 1.27, 5 EA	28
5071-355	INTREX BLADE 13 X 8 X 70 X 01.37, 5 EA	28
5071-356	INTREX BLADE 13 X 8 X 70 X 1.47, 5 EA	28
5071-519	LG BONE OSC BLADE 21 X 95 X 1.27 X 1.27MM 5 EA	29, 34
5071-525	OSC BLD 19 X 95 X 1.37 X 1.37MM STERILE 5 EA	29, 35
5071-526	OSC BLD 18.5 X 107 X 1.24 X 1.24MM STERILE 5 EA	29, 32
5071-527	OSC BLD 19 X 80 X 1.27 X 1.27MM STERILE 5 EA	29, 33
5071-528	OSCBLD 25 X 73 X 0.89 X 0.89MM STERILE 5 EA	29, 30
5071-529	OSCBLD 19.5 X 105 X 1.27 X 1.27MM STERILE 5 EA	29, 35
5071-530	OSCBLD 19 X 95 X 1.37 X 1.37MM STERILE 5 EA	29, 35
5071-531	OSC BLD 25.4 X 85 X 1.27 X 1.27MM STERILE 5 EA	29, 33
5071-532	OSC BLD 12 X 80 X 0.9 X 0.9MM STERILE 5 EA	29, 30

Cat. No.	Description	Page No.
5071-533	OSCBLD 21 X 84.5 X 0.89 X 0.89MM STERILE 5 EA	29, 30
5071-534	OSCBLD 25.4 X 79.5 X 1.24 X 1.24MM STERIL 5 EA	29, 32
5071-538	OSC 25.4 X 95 X 1.0 X 1.0MM TAPER STERL 5 EA	29, 31
5071-539	OSCILLATING BLADE 25.4 X 95 X 1.37 NONSTERIL	29, 35
5071-547	LG BN OSC 25.4 X 86.0 X 1.19, 1.19MM 5 EA	29, 32
5071-548	LG BN OSC 12.7X86.0X1.19, 1.19MM 5 EA	29, 31
5071-550	ST OSCIL BLADE 49 X 63 X .6 MM 5 EA	40, 41
5071-551	ST OSCIL BLADE 32.5 X 63 X .6MM 5 EA	40
5071-552	ST OSCIL BLADE 13.5 X 64 X .6MM 5 EA	40, 41
5071-553	ST OSCIL BLADE 19.5 X 63 X .6MM 5 EA	40
5071-554	ST OSCIL BLD 71 X19.5 X 1.2MM 5 EA	40, 43
5071-555	ST OSCIL BLD 71 X33 X1.2MM 5 EA	40, 43
5071-556	ST OSCIL BLADE 33.5 X 64 X .8MM 5 EA	40, 41
5071-557	LG BN OSC BLD 12.5 X 73.8 X 0.63,1.06MM 5 EA	40, 42
5071-558	LG BN OSC BLD 18.5 X 73 X 1.24MM 5 EA	29, 32
5071-560	OSCBLD 25.4 X 95 X 0.86 X 1.0MM STERILE 5 EA	40, 42
5071-562	OSCBLD 25.4 X 90 X 1.0 X 1.0MM STERILE 5 EA	29, 31
5071-564	OSCBLD 25.4 X 90 X 1.27 X 1.27MM STERILE 5 EA	29, 34
5071-565	OSCBLD 25.4 X 90 X 1.47 X 1.47MM STERILE 5 EA	29, 35
5071-568	LG BN OSC BLD 16.5 X 95 X 1.27 X 1.27MM 5 EA	29, 34
5071-570-50	LRG BN OSC BLD STERILE 25 X 95 X 1.24MM 5 EA	29, 32
5071-571	LG BONE OSC BLD 9.5 X 30 X 0.64 X 0.84MM 5 EA	39
5071-572	ST OSCIL BLD 71 X 19.5 X 0.8MM 5 EA	40, 42
5071-573	STERILE OSC BLD 18.5 X 90 X 1.26, 1.26MM 5 EA	29, 32
5071-575	STERILE OSC BLD 90 X 31 X 1.26 X 1.26MM 5 EA	29, 33
5071-576	STRL LARGE BN BLD 16.5 X 95 X 1.27MM 5 EA	29, 34
5071-582	OSC BLD 13 X 90 X 1.27 X 1.27MM STERILE 5 EA	33
5071-583	OSCBLD 12.7 X 90 X 0.89 X 0.89MM STERILE 5 EA	29, 30
5071-589	OSCBLD 13 X 90 X 0.89 X 0.89MM STERILE 5 EA	29, 30
5071-590	LG BONE OSC BLADE 13 X 95 X 1.27 X 1.27MM 5 EA	29, 34
5071-594	OSCBLD 29.46 X 58.7 X 0.64 X 0.64MM STER 5 EA	29, 30
5072-100	ST REPL STRYKER SAG 24.94 X 73.79 X .64MM	36
5072-101	ST REPL BLD/STRYKER COATED, 19.5 X 1.27 X 86MM	36, 38
5072-102	ST REPL STRYKER SAG 24.82 X 90.47 X .89MM	36, 37
5072-105	ST REPL STRYKER SAG 24.82 X 73.79 X .89MM	36, 37
5072-109	ST REPL STRYKER SAG 20.7 X 85.04 X .89MM	36, 37
5072-110	ST REPL STRYKER SAG 24.82 X 73.79 X 1.27MM	36, 38
5072-111	ST REPL STRYKER SAG 24.82 X 80.14 X 1.27MM	36, 38
5072-140	ST REPL STRYKER SAG 29.46 X 58.7 X .64MM	36
5072-142	ST REPL BLD/STRYKER 25.4 X 1.2 X 90MM	36, 37
5072-143	ST REPL BLD/STRYKER 25.4 X .8 X 90MM	36
5072-145	ST REPL STRYKER SAG 9.12 X 25.22 X .64MM	36
5072-150	ST REPL STRYKER SAG 12.5 X 73.79 X .64MM	36
5072-151	ST REPL STRYKER SAG 24.82 X 85.67 X 1.19MM	36, 37
5072-152	ST REPL STRYKER SAG 12.45 X 1.19 X 82.18MM	36, 37
5072-158	ST REPL STRYKER SAG 12.45 X 82.12 X 1.27MM	36, 38
5072-176	ST REPL STRYKER SAG 24.82 X 80.14 X 1.50MM	36, 38
5072-177	ST REPL STRYKER SAG 24.82 X 82.42 X 1.37MM	36, 38
5072-181	ST REPL BLD/STRYKER 19.5 X 1.27 X 86MM	36, 38
5072-183	ST REPL STRYKER SAG 28.91 X 1.27 X 84.47MM	36, 38
5072-185	STERILE REPL BLADE/STRYKER 2108-185	36, 38
5072-195	STERILE REPL BLD/STRYKER COATED, 19.5 X .9 X 80MM	36, 37
5072-218	STERILE REPL BLADE/STRYKER 2108-218	36, 37
5089-208	ST SIDE CUT CRBD BUR 1.5MM X 8.0MM 5 EA	52
5090-247	ST WIRE PASS STEEL BUR, SHORT, 1 X 19MM 5 EA	51
5090-248	ST WIRE PASS STEEL BUR, SHRT, 1.5 X 19MM 5 EA	51
5090-249	ST WIRE PASS STEEL BUR, SHORT,2 X 19MM 5 EA	51
5091-080	DERMABRADER BUR, DIAMOND, MEDIUM, STR, 4	51
5091-081	DERMABRADER BUR, DIAMOND, MEDIUM, STR, 7	51

Numerical Index



Cat. No.	Description	Page No.
5091-082	DERMABRADER BUR, DIAMOND, MEDIUM, STR, 12	51
5091-083	DERMABRADER BUR, DIAMOND, MED, TAPERED,	51
5091-201	ST SIDE CUT CRBDE BUR, MED, STR, 1 X 5MM 5 EA	52
5091-202	ST SIDE CUT CARBIDE BURS, MED, STR 5 EA	52
5091-204	SIDE CUT CRBD BURS, MED, STR,1.5 X 5.1MM 5 EA	52
5091-206	ST SIDE CUT CARBIDE BURS, MED, TAPER 5 EA	52
5091-212	ST SIDE CUT CBD BURS, MED, LIND 1.6MM 5 EA	53
5091-213	MICRO TAPERD FISSURE BUR MED STER 5 EA	53
5091-214	ST SIDE CUT CARBIDE BUR MED, TAPER, 5 EA	52
5091-215	ST SIDE CUT CARBIDE BUR MED, TAPER, 5 EA	52
5091-216	ST SIDE CUT CARBIDE BUR MED, STR, 5 EA	52
5091-217	ST SIDE CUT CARBIDE BUR MED, STR, 5 EA	52
5091-218	ST SIDE CUT CARBD BUR MED TAP 1.6M 5 EA	52
5091-219	ST SIDE CUT CARB BUR MED, ROUND 1.2M 5 EA	52
5091-221	ST ROUND CARBIDE BUR, MEDIUM, 1.8MM 5 EA	51
5091-222	ST ROUND CARBIDE BURS, MEDIUM, 1.5MM 5 EA	51
5091-223	ST ROUND CARBIDE BUR, MEDIUM, 2.3MM 5 EA	51
5091-224	ST ROUND CARBIDE BUR, MEDIUM, 2MM 5 EA	51
5091-225	ST ROUND CARBIDE BURS, MEDIUM, 2.4MM 5 EA	51
5091-226	ST ROUND CARBIDE BURS, MEDIUM, 3MM 5 EA	51
5091-228	ST ROUND CARBIDE BURS, MEDIUM, 4MM 5 EA	51
5091-230	ST ROUND CARBIDE BURS, MEDIUM, 5MM 5 EA	51
5091-232	ST ROUND CARBIDE BURS, MEDIUM, 6.5MM 5 EA	51
5091-236	ST OVAL CARBIDE BURS, MEDIUM 4 X 8MM 5 EA	52
5091-238	ST OVAL CARBIDE BURS, MED, 5.5 X 10MM 5 EA	52
5091-242	ST SWANSON REAMER STEEL BUR, MED, 5 EA	51
5091-243	ST SWANSON REAMER STEEL BURS, MED, 5 EA	51
5091-244	ST SWANSON REAMER STEEL BURS, MED, 5 EA	51
5091-245	ST SWANSON REAMER STEEL BUR, MED 5MM 5 EA	51
5091-247	ST WIRE PASS STEEL BUR,MED, 1.0 X 5 EA	51
5091-248	ST WIRE PASS STEEL BURS, MED, 5 EA	51
5091-249	ST WIRE PASS STEEL BURS MED, 2 X 1MM 5 EA	51
5091-252	ST BARREL CUT CARBIDE BURS MED 5 EA	52
5091-254	ST BARREL CUT CARBIDE,BURS MED, 5 EA	52
5091-260	ST ROUND DIAMOND BURS, MED, 2MM 5 EA	51
5091-264	ST ROUND DIAMOND BURS, MED, 4MM 5 EA	51
5091-268	ST ROUND DIAMOND BURS, MED, 6MM 5 EA	51
5091-270	ST OVAL DIAMOND BURS, MED, 4 X 8MM 5 EA	51
5091-271	MICRO TAPERD FISSURE BUR MED STER 5 EA	53
5091-272	MICRO TAPERD FISSURE BUR MED STER 5 EA	53
5092-203	ST SIDE CUT CBD BUR, LONG, TAPER 1.7MM 5 EA	52
5092-204	SIDE CUT CBD BUR,ING,STR 1.5 X 5.1MM 5 EA	52
5092-206	ST SIDE CUT CBD BUR LG,TAPER 2 X 7.5MM 5 EA	52
5092-212	ST SIDE CUT CBD BURS, MED, LIND 1.6MM 5 EA	53
5092-214	ST SIDE CUT CBD BURS, LONG, TAPER 5 EA	52
5092-220	ST ROUND CARBIDE BURS, LONG, 1MM 5 EA	51
5092-222	ST ROUND CARBIDE BURS, LONG, 1.5MM 5 EA	51
5092-224	ST ROUND CARBIDE BURS, LONG, 2MM 5 EA	51
5092-226	ST ROUND CARBIDE BURS, LONG, 3MM 5 EA	51
5092-228	ST ROUND CARBIDE BURS, LONG, 4MM 5 EA	51
5092-230	ST ROUND CARBIDE BURS, LONG, 5MM 5 EA	51
5092-232	ST ROUND CARBIDE BURS LONG, 6.5MM 5 EA	51
5092-236	ST OVAL CARBIDE BURS, LONG, 4 X 8MM 5 EA	51, 52
5092-238	ST OVAL CARBIDE BURS, LONG, 5.5 X 10MM 5 EA	52
5092-247	DISP WIRE PASS STEEL BUR, 1.0 X 19, LONG, 5 EA	51
5092-252	ST BARRELL CUT CARBIDE BURS, LONG, 2MM 5 EA	52
5092-254	ST BARRELL CUT CARBIDE BUR, LONG, 4MM 5 EA	52
5092-260	ST ROUND DIAMOND BUR, LONG 2.0MM 5 EA	51
5092-262	ST ROUND DIAMOND BURS, LONG, 3MM 5 EA	51

Cat. No.	Description	Page No.
5092-264	ST ROUND DIAMOND BURS, LONG, 4MM 5 EA	51
5092-266	ST ROUND DIAMOND BURS, LONG, 5MM 5 EA	51
5092-268	ST ROUND DIAMOND BURS, LONG, 6MM 5 EA	51
5092-270	ST OVAL DIAMOND BURS, LONG, 4 X 8MM 5 EA	51
5092-271	MICRO TAPERD FISSURE BUR LONG STER 5 EA	53
5092-272	MICRO TAPERD FISSURE BUR LONG STER 5 EA	53
5092-273	MICRO TAPERD FISSURE BUR LONG STER 5 EA	53
5092-274	ST RHINOPLASTY DIAMOND BURS, LONG, 5 EA	51
5092-282	ST BUR HVY GRIT DIAM. 2MM 5/BOX	53
5092-283	ST BUR HVY GRIT DIAM. 3MM 5 EA	53
5092-284	ST BUR HVY GRIT DIAM. 4MM 5 EA	53
5092-285	ST BUR HVY GRIT DIAM. 5MM 5 EA	53
5092-286	ST BUR HVY GRIT DIAM. 6MM 5 EA	53
5092-291	ST RND CYL BUR LNG 3MM/AM8 5 EA	53
5092-292	ST RND/CYL BUR LG 4.0MM 5 PK	53
5093-220	ST ROUND BUR, CARBIDE 1.0MM 5 EA	51
5093-221	ST RND BUR CARBIDE .5MM 5 EA	51
5093-224	ST ROUND CARBIDE BURS, X-LONG, 2MM 5 EA	51
5093-226	ST RND BUR CARBIDE 3.0MM 5 EA	51
5093-228	ST ROUND CARBIDE BURS, X-LONG, 4MM 5 EA	51
5093-230	ST ROUND CARBIDE BURS, X-LONG, 5MM 5 EA	51
5093-232	ST RND BUR CARBIDE 6.5MM 5 EA	51
5093-236	ST OVAL CARBIDE BURS, X-LONG, 4 X 8MM 5 EA	52
5093-238	ST OVAL CARBIDE BURS, 5.5 X 10, X-LONG 5 EA	52
5093-260	ST ROUND DIAMOND BURS, X-LONG, 2MM 5 EA	51
5093-262	ST ROUND DIAMOND BURS, X-LONG, 3MM 5 EA	51
5093-264	ST RND DIAMOND BUR XL 4.0MM 5 EA	51
5093-266	ST ROUND DIAMOND BURS, X-LONG, 5MM 5 EA	51
5093-282	ST BUR HVY GRIT DIAM. 2MM 5 EA	53
5093-283	ST BUR HVY GRIT DIAM. 3MM 5 EA	53
5093-284	ST BUR HVY GRIT DIAM. 4MM 5 EA	53
5093-285	ST BUR HVY GRIT DIAM. 5MM 5 EA	53
5093-286	ST BUR HVY GRIT DIAM. 6MM 5 EA	53
5093-291	ST ROUND CYLNDRL BUR, M-8 TYPE, LONG 5 EA	53
5144-002	MODIFIED SCHRADER COUPLER	8
5271-502	PRIMECUT® OSCBLD 29 X 74 X 0.64 X 0.64 ST 5 EA	29, 30
5271-561	PRIMECUT OSCBLD 25.4 X 90 X 1.27 X 1.27MM 5 EA	29, 34
5271-580	PRIMECUT OSCBLD 10 X 85 X 1.27 X 1.27 ST 5 EA	29, 33
6020-021	MICROPOWER® MEDIUM SPD DRILL REMOVE LEVER	15
6020-022	MICROPOWER SAGITTAL SAW REMOVE LEVER	15
6020-023	MICROPOWER RECIPROCATING SAW REMOVE LEVR	15
6020-024	MICROPOWER OSCILLATING SAW REMOVE LEVER	15
6020-025	MICROPOWER HS DRILL REMOVE LIVR ORAL MAX	15
6020-026	MICROPOWER HS DRILL REMOVE LEVER ORTHO	15
6020-260	SMARTGUARD® IRRIGATOR SB IRRIG 30 PER BOX IS 1 EA	16
6021-021	MICROPOWER® MEDIUM SPD DRILL PERM LEVER	15
6021-022	MICROPOWER SAGITTAL SAW PERMANENT LEVER	15
6021-023	MICROPOWER RECIPROCATING SAW PERM LEVER	15
6021-024	MICROPOWER OSCILLATING SAW PERM LEVER	15
6021-025	MICROPOWER HS DRILL PERM LEVER ORAL MAX	15
6021-026	MICROPOWER HS DRILL PERM LEVER ORTHO	15
7007-03	10 X 7 STAPLIZER CARTRIDGE 3 EA	54
7010-03	10 X 10 STAPLIZER CARTRIDGE 3 EA	54
7015-03	10 X 15 STAPLIZER CARTRIDGE 3 EA	54
7020-001	ULTRAPOWER® HI-SPEED DRILL W/O HOSE	18, 24, 25
7020-002	ULTRAPOWER LO-SPEED DRILL W/O HOSE	18, 24, 25
7020-003	ULTRAPOWER PERFORATOR DRIVE W/O HOSE	18, 24, 25
7020-010	ULTRAPOWER SH BUR GUIDE, RED/LIKE MDS-X	18, 24, 25, 61 – 65
7020-011	ULTRAPOWER MED BUR GUIDE, CPR/LIKE MDS-O	18, 24, 25, 61 – 65

Numerical Index



Cat. No.	Description	Page No.
7020-012	ULTRAPOWER® L BUR GUARD, MUST/LIKE MDS-M	18, 24, 25, 61 – 65
7020-013	ULTRAPOWER, XL BUR GUARD,LIME/LIKE MDS A	18, 24, 25, 61 – 65
7020-014	ULTRAPOWER, SHORT REV EXTTEAL/LIKE MDS-T	18, 24, 25, 61 – 64
7020-015	ULTRAPOWER MEDIUM REV EXTPURP/LIKE MDS-R	18, 24, 25, 61, 62, 64
7020-016	ULTRAPOWER LARGE REV EXT BLUE/LIKE MDS-R	18, 24, 25, 61, 62, 64
7020-017	ULTRAPOWER SHORT NEURO GUIDE, BL/LIKE M	18, 24, 25, 60
7020-018	ULTRAPOWER MEDIUM NEURO GUIDE, GR/LIKE	18, 24, 25, 60
7020-019	ULTRAPOWER LONG NEURO GUIDE, BR/LIKE	18, 24, 25, 60
7020-022	ULTRAPOWER 90 DEG ANGLE ATTACHMENT, LIK	18, 24, 25
7020-023	ULTRAPOWER KEYLESS 20D ANG ATT	18, 24, 25
7020-024	ULTRAPOWER KEYLESS XL 20D ANGLE	18, 24, 25
7020-040	ULTRAPOWER KEY WRENCH	24, 25
7020-041	ULTRAPOWER ATTACHMENT SPRAY	24, 25
7020-045	ULTRAPOWER FOOT CONTROL W/HOSE	18, 24, 25
7020-046	ULTRAPOWER NEURO BUR STORAGE CAB	17, 24, 25
7020-047	ULTRAPOWER REV BUR STORAGE CABINET	24, 25
7020-050	ULPWR STOR/AUTOCLAVE CASE, COMPLETE	24
7020-051	ULTRAPOWER STOR/AUTOCLAVE CASE, BASIC	25
7020-052	ULPWR STOR/AUTOCLAVE CASE, NEURO	25
7021-012	ST UPWR BUR TPRD 1.5MM X 8MM	63, 65
7021-013	ST ULTRAPOWER TRPD 1.8MM X 11MM	63, 65
7021-014	ST ULTRAPOWER TRPD	65
7021-015	ST ULTRAPOWER BUR TRPD 2.2MM X 16MM	63
7021-024	ST ULTRAPOWER BUR RND 2.0MM	61
7021-025	ST ULTRAPOWER BUR RND 2.5MM	61
7021-026	ST ULTRAPOWER BUR RND 3.0MM	61
7021-027	ST ULTRAPOWER BUR RND 4.0MM	61
7021-028	ST ULTRAPOWER BUR RND 5.0MM	61
7021-029	ST ULTRAPOWER BUR RND 6.0MM	61
7021-030	ST ULTRAPOWER BUR RND 6.5MM	61
7021-031	ST ULTRAPOWER BUR RND 7.5MM	61
7021-032	ST ULTRAPOWER BUR RND 9.0MM	61
7021-033	ST ULTRAPOWER BUR RND 10.0MM	61
7021-034	ST ULTRAPOWER BUR RND 8.0MM	61
7021-036	ST ULTRAPOWER BUR RND/CYL2.2MM	63
7021-037	ST ULTRAPOWER BUR RND/CYL 3.0MM	63
7021-040	ST ULTRAPOWER BUR WIREPASS 1.0MM	65
7021-041	ST ULTRAPOWER BUR WIREPASS 1.5MM	65
7021-042	ST ULTRAPOWER BUR WIREPASS 2.0MM	65
7021-043	ST ULTRAPOWER BUR STRT HD 1.2 X 6MM	63
7021-051	ST UP BUR TREPHINE 5.3MM	64
7021-062	ST ULTRAPOWER BUR DMD 2.0MM	61
7021-063	ST ULTRAPOWER BUR DMD 3.0MM	61
7021-064	ST ULTRAPOWER BUR DMD 4.0MM	61
7021-065	ST ULTRAPOWER BUR DMD 5.0MM	61
7021-066	ST ULTRAPOWER BUR DMD 6.0MM	61
7021-067	ST ULTRAPOWER BUR RND DMD7.0MM	61
7021-074	ST ULTRAPOWER BUR RND DMD CRS 4.0MM	62
7021-075	ST ULTRAPOWER BUR RND DMD CRS 5.0MM	62
7021-077	ST ULTRAPOWER BUR RND DMDCRS 7.0MM	62
7021-081	ST ULTRAPOWER BUR ACORN 6.0MM	64
7021-083	ST ULTRAPOWER BUR ACORN 9.0MM	64
7021-092	ST ULTRAPOWER DMD WHEEL 25.4	65
7021-094	ST ULPWR BUR RND END 3.2/MDS WH2	65
7021-095	ST ULTRAPOWER BUR OVAL 4.0MM	65
7021-096	ST ULTRAPOWER BUR OVAL 5.5MM	65
7021-102	ST UPWR BUR STRT 5X8/MDS-0-12	62
7021-106	ST UPWR BUR STRT 7.5X9/MDS 0-5	62
7021-109	ST UPWR BUR STRT 9X9MM/MDS-0-4	62

Cat. No.	Description	Page No.
7021-112	ST UPWR BUR TPRD 1.5 X 8MM	63
7021-113	ST UP BUR TPRD 1.8 X 11MM	63
7021-114	ST UP BUR TPRD 2 X 16MM	63
7021-115	ST UP BUR TPRD 2.2 X 16MM	63
7021-116	ST UP BUR TPRD 2.2X23MM	63
7021-119	ST ULTRAPOWER® BUR 1.5MM CROSSCUT	63
7021-122	ST ULTRAPOWER BUR RND 1.0MM	61
7021-123	ST ULTRAPOWER BUR RND 1.5MM	61
7021-124	ST ULTRAPOWER BUR RND 2.0MM	61
7021-125	ST ULTRAPOWER BUR RND 2.5MM	61
7021-126	ST ULTRAPOWER BUR RND 3.0MM	61
7021-127	ST ULTRAPOWER BUR RND 4.0MM	61
7021-128	ST ULTRAPOWER BUR RND 5.0MM	61
7021-129	ST ULTRAPOWER BUR RND 6.0MM	61
7021-130	ST ULTRAPOWER BUR RND 6.5MM	61
7021-131	ST ULTRAPOWER BUR RND 7.5MM	61
7021-132	ST ULTRAPOWER BUR RND 9.0MM	61
7021-133	ST ULTRAPOWER BUR RND 10.0MM	61
7021-134	ST ULTRAPOWER BUR RND 8.0MM	61
7021-136	ST ULTRAPOWER BUR RND/CYL 2.2MM	63
7021-137	ST UPWR BUR RND CYL 3.0MDS 0-8	63
7021-140	ST ULTRAPOWER BUR WIREPASS 1.0MM	65
7021-141	ST ULTRAPOWER BUR WIREPASS 1.5MM	65
7021-141-35	ST UPWR DPTH LMT DRILL 1.1 X 3.5MM	65
7021-141-50	ST UPWR DPTH LMT DRILL 1.1 X 5.0MM	65
7021-141-90	ST UPWR DPTH LMT DRILL 1.1 X 9.0MM	65
7021-142	ST ULTRAPOWER BUR WIREPASS 2.0MM	65
7021-143	ST UP BUR STRT HD 1.2 X 6MM	63
7021-145-70	ST UPWR DPTH LMT DRILL 1.5 X 7.0MM	65
7021-161	ST ULTRAPOWER BUR DMD 1.0MM	61
7021-162	ST ULTRAPOWER BUR DMD 2.0MM	61
7021-163	ST ULTRAPOWER BUR DMD 3.0MM	61
7021-164	ST ULTRAPOWER BUR DMD 4.0MM	61
7021-165	ST ULTRAPOWER BUR DMD 5.0MM	61
7021-166	ST ULTRAPOWER BUR DMD 6.0MM	61
7021-167	ST ULTRAPOWER BUR RND DMD 7.0MM	61
7021-171	ST ULTRAPOWER BUR RND DMDCRS 1.0MM	62
7021-172	ST ULTRAPOWER BUR DMD CRS 2.0MM	62
7021-173	ST ULTRAPOWER BUR DMD CRS 3.0MM	62
7021-174	ST ULTRAPOWER BUR DMD CRS 4.0MM	62
7021-175	ST ULTRAPOWER BUR DMD CRS 5.0MM	62
7021-176	ST ULTRAPOWER BUR DMD CRS 6.0MM	62
7021-177	ST UP BUR RND CRS DIAMOND 7.0MM	62
7021-181	ST ULTRAPOWER BUR ACORN 6.0/MDS 0.3	64
7021-182	ST UPWR BUR ACORN 7.5MM MDS 0-2	64
7021-183	ST ULTRAPOWER BUR ACORN 9.0/MDS 0-1	64
7021-195	ST ULTRAPOWER BUR OVAL 4.0 X 8.0MM	65
7021-196	ST ULTRAPOWER BUR OVAL 5.5 X 10MM	65
7021-201	ST UPWR BUR STRT 3 X 20/MDS M-13	62
7021-202	ST UPWR BUR STRT 5 X 8/MDS M-12	62
7021-206	ST UPWR BUR STRT 7.5 X 9 MDS M-5	62
7021-207	ST UPWR BUR STRT 7.5X28MDS M15	62
7021-209	ST UPWR BUR STRT 9 X 9MM/MDS M-4	62
7021-210	ST ULTRAPOWER BUR STRT 10.5 X 11MDS M14	62
7021-212	ST UPWR BUR TAPERED 1.5MM	63
7021-214	ST UPWR BUR TPRD 2.0 X 16MM	63
7021-218	ST UPWR BUR TPRD 3 X 36/MDS M-10	63
7021-220	ST ULTRAPOWER BUR RND 0.5MM	61
7021-222	ST ULTRAPOWER® BUR RND 1.0MM	61

Numerical Index



Cat. No.	Description	Page No.
7021-223	ST ULTRAPOWERS BUR RND 1.5MM	61
7021-224	ST ULTRAPOWERS BUR RND 2.0MM	61
7021-225	ST ULTRAPOWERS BUR RND 2.5MM	61
7021-226	ST ULTRAPOWERS BUR RND 3.00MM	61
7021-227	ST ULTRAPOWERS BUR RND 4.0MM	61
7021-228	ST ULTRAPOWERS BUR RND 5.0/MOS M-35	61
7021-229	6.0/MDS M-33 ST ULTRAPOWERS B	61
7021-230	ST ULTRAPOWERS BUR RND 6.5MM	61
7021-231	ST ULTRAPOWERS BUR RND 7.5/MDS M-32	61
7021-232	ST ULTRAPOWERS BUR RND 9.0/MDS M-31	61
7021-233	ST ULTRAPOWERS BUR RND 10.0	61
7021-235	ST UPWR BUR RND CYL 1.8MM	63
7021-236	ST UPWR BUR ROUND CYL 2.2MM	63
7021-237	ST ULTRAPOWERS BUR RND CYL 3.0/MDS M-8	63
7021-243	ST UP BUR STRT HD 1.2 X 6MM	63
7021-250	ST UP BUR TREPHINE 3.4MM	64
7021-252	ST UP BUR TREPHINE 10.7MM	64
7021-253	ST UP BUR TREPHINE 13.5MM	64
7021-255	ST UP BUR TREPHINE 16.8MM	64
7021-256	ST ULTRAPOWERS BUR CUTTER 10.7MM	65
7021-257	ST ULTRAPOWERS BUR CUTTER 13.5MM	65
7021-258	ST ULTRAPOWERS BUR CUTTER 16.8MM	65
7021-261	ST ULTRAPOWERS BUR RND DMD 1.0MM	61
7021-262	ST ULTRAPOWERS BUR DND 2.0MM	61
7021-263	ST ULTRAPOWERS BUR DMD 3.0MM	61
7021-264	ST ULTRAPOWERS BUR DMD 4.0MM	61
7021-265	ST ULTRAPOWERS BUR DMD 5.0MM	61
7021-266	ST ULTRAPOWERS BUR DMD 6.0MM	61
7021-267	ST ULTRAPOWERS BUR RND DMD 7.0MM	61
7021-271	ST ULTRAPOWERS BUR RND DMD CRS 1.0MM	62
7021-272	ST ULTRAPOWERS BUR RND DMD CRS 2.0MM	62
7021-273	ST ULTRAPOWERS BUR RND DMD CRS 3.0MM	62
7021-274	ST ULTRAPOWERS BUR RND DMD CRS 4.0MM	62
7021-275	ST ULTRAPOWERS BUR RND DMD CRS 5.0MM	62
7021-276	ST ULTRAPOWERS BUR RND DMD CRS 6.0MM	62
7021-277	ST ULTRAPOWERS BUR RND DMD CRS 7.0MM	62
7021-279	ST UPWR BUR DMD R/C3.0 MDS M8D	64
7021-280	ST UPWR BUR ACORN 5.0/MDS M25	64
7021-281	ST ULTRAPOWERS BUR ACORN 6.0/MDS M-3	64
7021-282	ST UPWR BUR ACORN 7.5MM/MDS M2	64
7021-283	ST BUR ACORN 9.0/RPL MIDAS M-1	64
7021-292	ST ULTRAPOWERS DMD WHEEL/MDS M-51	65
7021-294	ST ULTRAPOWERS BUR RND END 3.2/MDS M-5	65
7021-295	ST ULTRAPOWERS BUR OVAL 4.0 X 8MM	65
7021-296	ST ULTRAPOWERS BUR OVAL 5.5 X 10MM	65
7021-297	ST UPWR BUR BARREL 10MM/MDS M23	65
7021-301	ST UPWR BUR STRT 3 X 20/MDS AM13	63
7021-302	ST UPWR BUR STRT 5 X 8/MDS AM12	62
7021-303	ST UPWR BUR STRT 5 X 17/MDS AM9	62
7021-304	ST UPWR BUR STRT 6 X 8/MDS AM11	62
7021-305	ST UPWR BUR STRT 7.5 X 5/MDS AM7	62
7021-309	ST UPWR BUR STRT 9 X 9MM/MDS AM4	62
7021-310	ST UP BUR STRT 10.5 X 11MM	62
7021-314	ST UPWR BUR TPRD 2.0 X 16MM	63
7021-315	ST UPWR BUR TPRD 2.2 X 16MM	63
7021-318	ST ULTRAPOWERS BUR TPRD 3 X 36/MDS AM-10	63
7021-322	ST ULTRAPOWERS BUR RND 1.0MM	61
7021-323	ST ULTRAPOWERS BUR RND 1.5MM	61
7021-324	ST ULTRAPOWERS® BUR RND 2.0MM	61

Cat. No.	Description	Page No.
7021-325	ST ULTRAPOWER BUR RND 2.5MM	61
7021-326	ST ULTRAPOWER BUR RND 3.0MM	61
7021-327	ST ULTRAPOWER BUR RND 4.0MM	61
7021-328	ST ULTRAPOWER BUR RND 5.0/MDS AM-35	61
7021-329	ST ULTRAPOWER BUR RND 6.0/MDS AM-33	61
7021-331	ST BUR RND 7.5/RPL MIDAS AM-32	61
7021-332	ST BUR RND 9.0/RPL MIDAS AM-31	61
7021-333	ST ULTRAPOWER BUR RND 10.0MM	61
7021-335	ST UPWR BUR RND CYL 1.8MM	63
7021-336	ST UPWR BUR RND CYL 2.2MM	63
7021-337	ST ULTRAPOWER BUR RND CYL 3.0/MDS AM-	63
7021-338	ST UPWR BUR RND CYL 1.8MM	63
7021-361	ST ULTRAPOWER BUR RND DMD 1.0MM	61
7021-362	ST ULTRAPOWER BUR DMD 2.0MM	61
7021-363	ST ULTRAPOWER BUR DMD 3.0MM	61
7021-364	ST ULTRAPOWER BUR DMD 4.0MM	61
7021-365	ST ULTRAPOWER BUR DMD 5.0MM	61
7021-366	ST ULTRAPOWER BUR RND DMD 6.0MM	61
7021-367	ST ULTRAPOWER BUR RND DMD 7.0MM	61
7021-371	ST ULTRAPOWER BUR RND DMD CRS 1.0MM	62
7021-372	ST ULTRAPOWER BUR RND DMD CRS 2.0MM	62
7021-373	ST ULTRAPOWER BUR RND DMD CRS 3.0MM	62
7021-374	ST ULTRAPOWER BUR RND DMD CRS 4.0MM	62
7021-375	ST ULTRAPOWER BUR RND DMD CRS 5.0MM	62
7021-376	ST ULTRAPOWER BUR RND DMD CRS 6.0MM	62
7021-377	ST UP BUR RND CRS DIAMOND 7.0MM	62
7021-378	ST UPWR BUR RND CYL 1.9MM	64
7021-379	ST UPWR BUR DMD RC 3.0MDS AM8D	64
7021-380	ST UPWR BUR ACORN 5.0/MDS AM25	64
7021-381	ST ULTRAPOWER BUR ACORN 6.0/MDS AM-3	64
7021-382	ST UPWR BUR ACORN 7.5MDS AM2	64
7021-383	ST ULTRAPOWER BUR ACORN 9.0/MDS AM-1	64
7021-391	ST UPWR BUR FRSTRM 6.5MDS AM24	65
7021-392	ST ULTRAPOWER DMD WHEEL /MDS AM-51	65
7021-395	ST ULTRAPOWER BUR OVAL 4.0MM	65
7021-396	ST ULTRAPOWER BUR OVAL 5.5MM	65
7021-406	ST ULTRAPOWER BUR RND 3.0MM	62
7021-408	ST UPWR BUR STRT 9 X 5MM/MDS-TU6	62
7021-409	ST UPWR BUR STRT 9 X 9MM/MDS-TU4	62
7021-426	ST ULTRAPOWER BUR RND 3.0MM	61,
7021-427	ST ULTRAPOWER BUR RND 4.0MM	61, 62
7021-428	ST ULTRAPOWER BUR RND 5.0MM	61
7021-429	ST ULTRAPOWER BUR RND 6.0/MDS TU-33	61
7021-431	ST ULTRAPOWER BUR RND 7.5/MDS TU-32	61
7021-432	ST ULTRAPOWER BUR RND 9.0/MDS TU-31	61
7021-433	ST ULTRAPOWER BUR RND 10.0MM	61
7021-437	ST UPWR BUR RND CYL 3.0MDS TUB	63
7021-474	ST ULTRAPOWER BUR RND DMD 4MM	62
7021-482	ST UPWR BUR ACORN 7.5/MDS TU2	64
7021-483	ST ULTRAPOWER BUR ACORN 9.0/MDS TU-1	64
7021-492	ST ULTRAPOWER BUR DMD WHEEL/MDS TU-51	65
7021-506	ST ULTRAPOWER BUR RND 3.0MM	62
7021-509	ST UPWR BUR STRT 9 X 9MM/MDS-R4	62
7021-510	ST ULTRAPOWER BUR STRT 10.5 X 11 R14	62
7021-526	ST ULTRAPOWER BUR RND 3.0MM	61
7021-528	ST ULTRAPOWER BUR RND 5.0MM	61
7021-529	ST ULTRAPOWER BUR RND 6.0/MDS R-33	61
7021-531	ST ULTRAPOWER BUR RND 7.5/MDS R-32	61
7021-532	ST ULTRAPOWER BUR RND 9.0/MDS R-31	61

Numerical Index



Cat. No.	Description	Page No.
7021-533	ST ULTRAPOWERS BUR RND 10.0MM	61
7021-581	ST ULTRAPOWERS BUR ACORN 6.0/MDS R-3	64
7021-583	ST ULTRAPOWERS BUR ACORN 9.0/MDS R-1	64
7021-610	ST ULTRAPOWERS BUR STRT 10.5 X 11 RX-1	62
7021-631	ST ULTRAPOWERS BUR RND 7.5/MDS RX-32	61
7021-632	ST ULTRAPOWERS BUR RND 9.0/MDS RX-31	61
7021-633	ST ULTRAPOWERS BUR RND 10.0MM	61
7021-681	ST ULTRAPOWERS BUR ACORN 6.0/MDS RX-3	64
7021-683	ST ULTRAPOWERS BUR ACORN 9.0/MDS RX-1	64
7021-713	ST ULTRAPOWERS BUR TPRD 1.8 X 11	60, 63
7021-815	ST ULTRAPOWERS BUR TPRD 2.2 X 16	60, 63
7021-917	ST ULTRAPOWERS BUR TPRD 3 X 25/MDS S1	60, 63
7021-960	E9000 ULTRAPOWERS BUR SIDE CUTTING LONG	60
7307-03	13 X 7 STAPLIZER CARTRIDGE 3 EA	54
7310-03	13 X 10 STAPLIZER CARTRIDGE 3 EA	54
7315-03	13 X 15 STAPLIZER CARTRIDGE 3 EA	54
7320-03	13 X 20 STAPLIZER CARTRIDGE 3 EA	54
7610-03	16 X 10 STAPLIZER CARTRIDGE 3 EA	54
7615-03	16 X 15 STAPLIZER CARTRIDGE 3 EA	54
7620-03	16 X 20 STAPLIZER CARTRIDGE 3 EA	54
7625-03	16 X 25 STAPLIZER CARTRIDGE 3 EA	54
7707-03	7 X 7 STAPLIZER CARTRIDGE 3 EA	54
7710-03	7 X 10 STAPLIZER CARTRIDGE 3 EA	54
A101	20 FOOT HOSE	22
A201	HOSE W/FULL AIR RETURN	8, 22
A9350	OTOLARYNGOLOGY BLADE 4.2MM CUDA 6 EA	55
A9360	OTOLARYNGOLOGY BLADE 4.2MM GATOR 6 EA	56
C8803	ACL BLADE, FINE, STRAIGHT, 8.0 WITH GUIDE/12 WITHOUT GUIDE, 9.4 X 41.0MM	47
C8804	ACL BLADE, FINE, STRAIGHT, 8.0 FREEHAND, 9.4 X 41.0MM	47
C8806	ACL BLADE, FINE, STRAIGHT, 10.0 FREEHAND, 9.4 X 41.0MM	47
C9863	3-PEDAL FOOTSWITCH	7
C9911	RHINOTEC SPHERICAL BUR, 2.9MM, HOODED, 7.6CM WORKING LENGTH, 6/BOX	58
C9912	RHINOTEC SPHERICAL BUR, 3.5MM, HOODED, 7.6CM WORKING LENGTH, 6/BOX	58
C9950	RHINOTEC CUDA BLADE, 2.0MM, 7.6CM WORKING LENGTH, 6/BOX	55
C9951	RHINOTEC CUDA BLADE, 2.9MM, 7.6CM WORKING LENGTH, 6/BOX	55
C9952	RHINOTEC CUDA BLADE, 3.5MM, 7.6CM WORKING LENGTH, 6/BOX	55
C9960	RHINOTEC GATOR BLADE, 2.0MM, 7.6CM WORKING LENGTH, 6/BOX	56
C9961	RHINOTEC GATOR BLADE, 2.9MM, 7.6CM WORKING LENGTH, 6/BOX	56
C9962	RHINOTEC GATOR BLADE, 3.5MM, 7.6CM WORKING LENGTH, 6/BOX	56
C9990	RHINOTEC VORTEX ROUTER, 2.9MM, HOODED, 7.6CM WORKING LENGTH, 6/BOX	57
C9991	RHINOTEC VORTEX ROUTER, 3.5MM, HOODED, 7.6CM WORKING LENGTH, 6/BOX	57
D3000	ADVANTAGE CONSOLE	7
E306	UNIVERSAL AUTOCLAVE CASE	23
E4110	ST E9000 BUR STEEL WIRE PASS 1.0 X 38MM	60
E4115	ST E9000 BUR STEEL WIRE PASS 1.5 X 38MM	60
E4120	ST E9000 BUR STEEL WIRE PASS 2.0 X 38MM	60
E4208	ST SIDE CUT CARBIDE .8X4.9	60
E4217	LINDEMANN 1.6X31 STERILE	60
E4220	ST SIDE CUT CARBIDE 2X7.5	60
E5050	ST E9000 RND DMD CRS BUR 5.0 X 48MM	59
E5120	E9000 BUR RND DIAMOND CRS 2.0 X 38MM STERI	59
E5130	ST E9000 RND DMD CRS BURR 6.0 X 38MM	59
E5140	E9000 BUR RND DIAMOND CRS 4.0 X 38MM STERI	59
E5150	E9000 BUR RND DIAMOND CRS 5.0 X 38MM STERI	59
E5160	E9000 BUR RND DIAMOND CRS 3.0 X 38MM STERI	59
E5170	ST E9000 RND DMD CRS BUR 7.0 X 38MM	59
E5210	ST E9000 RND DMD CRS BUR 1.0 X 48MM	59
E5215	ST E9000 RND DMD CRS 1.5 X 48MM	59
E5220	ST E9000 RND DMD CRS BUR 2.0 X 48MM	59

Cat. No.	Description	Page No.
E5225	E9000 BUR RND DIAMOND CRS 2.5X48MM STERI	59
E5230	ST E9000° RND DMD CRS BUR 3.0 X 48MM	59
E5240	ST E9000 RND DMD CRS BUR 4.0 X 48MM	59
E6040	ST E9000 RND DMD BUR 4.0 X 30MM	59
E6105	E9000 BUR ROUND DIAMOND 0.5 X 38MM STERILE	59
E6110	E9000 BUR ROUND DIAMOND 1.0 X 38MM STERILE	59
E6115	E9000 BUR ROUND DIAMOND 1.5 X 38MM STERILE	59
E6120	E9000 BUR ROUND DIAMOND 2.0 X 38MM STERILE	59
E6125	E9000 BUR ROUND DIAMOND 2.5 X 38MM STERILE	59
E6130	E9000 BUR ROUND DIAMOND 3.0 X 38MM STERILE	59
E6140	ST E9000 RND DMD BUR 4.0 X 38MM	59
E6150	ST E9000 RND DMD BUR 5.0 X 38MM	59
E6160	ST E9000 RND DMD BUR 6.0 X 38MM	59
E6205	ST E9000 RND DMD BUR 0.5 X 48MM	59
E6207	ST E9000 RND DMD BUR 0.7 X 48MM	59
E6210	ST E9000 RND DMD BUR 1.0 X 48MM	59
E6215	ST E9000 RND DMD BUR 1.5 X 48MM	59
E6220	ST E9000 RND DMD BUR 2 X 48	59
E6225	E9000 BUR ROUND DIAMOND 2.5 X 48MM STERILE	59
E6230	ST E9000 RND DMD BUR 3.0 X 48MM	59
E6240	ST E9000 RND DMD BUR 4 X 48	59
E6250	ST E9000 RND DMD BUR 5.0 X 48MM	59
E8007	ST E9000 RND STEEL BUR 0.7 X 30MM	59
E8010	ST E9000 RND STEEL BUR 1.0 X 30MM	59
E8015	ST E9000 RND STEEL BUR 1.5 X 30MM	59
E8020	ST E9000 RND STEEL BUR 2.0 X 30MM	59
E8025	ST E9000 RND STEEL BUR 2.5 X 30MM	59
E8030LSO	ST E9000 RND CARBIDE BUR LSO 3 X 30MM	59
E8040LSO	ST E9000 RND CARBIDE BUR LSO 4 X 30MM	59
E8050LSO	ST E9000 RND CARBIDE BUR LSO 5 X 30MM	59
E8065LSO	ST E9000 RND CARBIDE BUR LSO 6.5 X 30MM	59
E8105	E9000 BUR ROUND 0.5 X 38MM STERILE	59
E8110	E9000 BUR ROUND 1.0 X 38MM STERILE	59
E8115	E9000 BUR ROUND 1.5 X 38 MM STERILE	59
E8120	E9000 BUR ROUND 2.0 X 38MM STERILE	59
E8125	E9000 BUR ROUND 2.5 X 38MM STERILE	59
E8130LSO	ST E9000 RND CARBIDE BUR LSO 3 X 38MM	59
E8140LSO	ST E9000 RND CARBIDE BUR LSO 4 X 38MM	59
E8150LSO	ST E9000 RND CARBIDE BUR LSO 5 X 38MM	59
E8165	ST E9000 RND CARBIDE 6.5 38MM	59
E8165LSO	ST E9000 RND CARBIDE BUR LSO 6.5 X 38MM	59
E8205	ST E9000 RND STEEL BUR 0.5 X 48MM	59
E8207	ST E9000 RND STEEL BUR 0.7 X 48MM	59
E8210	ST E9000 RND STEEL BUR 1.0 X 48MM	59
E8215	ST E9000 RND STEEL BUR 1.5 X 48MM	59
E8220	ST E9000 RND STEEL BUR 2.0 X 48MM	59
E8225	ST E9000 RND STEEL BUR 2.5 X 48MM	59
E8230LSO	ST E9000 RND CARBIDE BUR LSO 3 X 48MM	59
E8240LSO	ST E9000 RND CARBIDE BUR LSO 4 X 48MM	59
E8250LSO	ST E9000 RND CARBIDE BUR LSO 5 X 48MM	59
E8265LSO	E9000 BUR ROUND 6.5 X 48MM STERILE	59
E9000	E9000 CONSOLE 115 VOLT	7
E9005	E9000 HIGH SPEED SHAVER	17
E9010	E9000 HIGH SPEED DRILL	17
E9011-1	E9000 MEDIUM BUR GUARD	17, 59, 60
E9011-2	E9000 LONG BUR GUARD	17, 59, 60
E9011-3	E9000 XL BUR GUARD	17
E9011-7	E9000 SHORT NEURO GUARD	17, 60
E9011-8	E9000 MEDIUM NEURO GUARD	17, 60

Numerical Index



Cat. No.	Description	Page No.
E9011-9	E9000 LONG NEURO GUARD	17, 60
E9012	LOCKING COLLAR FOR E9010 DRILL	17
E9015	E9000® CRANIAL PERFORATOR DRIVE	17
E9315	SHAVER BLADE DE-CLOGGER NON-STERIL 6 EA	17
E9322	CLEANING BRUSHES	17
E9323	E9000,ACCESSORY,BUR RACK	17
E9324	BUR RACK, FOLDING, HOLDS UP TO 26 BURS FOR E9010 DRILL	17
E9350	4.2MM RHINOTEC® FESS BLADE CUDA ENT 6 EA	55
E9351	RHINOTEC CUDA® 3.7MM 6 EA	55
E9360	4.2MM RHINOTEC FESS BLD GATOR ENT 6 EA	56
E9361	RHINOTEC GATOR® 3.7MM 6 EA	56
E9363	3.7MM LARYNGEAL BLADE	56
E9414	TUBING, E9000 DRILL 5 EA	17
E9415A	TUBING & TIP E9010 DRILL W/IRRIG 5 EA	17
E9416	TUBING, 4.2MM BLD IRRIG FOR E9000 6 EA	17
E9417	TUBING, 3.7MM BLD IRRIG FOR E9000 6 EA	17
E9418	MICROCHOICE® TUBING W/IRRIGATN E9000 5 EA	14
L10D	LONG ROUND DIAMOND BUR	51
L12T	LONG TAPERED CARBD BUR	52
L13S	LONG STRAIGHT CARBID BUR	52
L17S	LONG STRAIGHT CARBIDE BUR	52
L17T	LONG TAPERED CARB BUR	52
L18R	LONG ROUND CARBIDE BUR	51
L20T	LONG TAPERED CARB BUR	52
L23R	LONG ROUND CARBIDE BUR	51
L40B	LONG BARREL CARBIDE BUR	52
L45C	LONG CONE CARBIDE BUR	53
L55B	LG,BR OVALCUT,5.5 X 10 CABUR	52
L60R	LONG ROUND CARBIDE BUR	51
M105A	BLITZ® CLEANER AND LUBRIC	8
M10S	MED STR SID CUT 1 X 5 BURR	52
M10T	MED TAPERED CARBIDE BUR	52
M12T	MED TAPERED CARBIDE BUR	52
M13S	MED STRAIGHT CARBIDE BUR	52
M15S	MED ST SID CT 1.5 X 7.5 BUR	52
M15T	MED TAP SID CUT 1.5 X 10 BU	52
M17S	MED STRAIGHT CARB BUR	52
M207	NITROGEN REGULATOR S/N	8
M208	DUAL NITROGEN REGULATOR	8
M20S	MED ST SID CUT 2 X 10 CAR BUR	52
M20T	MED TAPERED CARBIDE BUR	52
M317	LUBRICANT FOR AIR DRIVER	8
M322	DISS TO SCHRADER ADAPT	8
M40B	MED BARRELL CARBIDE BUR	52
M45C	MED CONE CARBIDE BUR	53
M55B	MED BRL OVALCUT 5.5 X 10 BUR	52
M60D	MED RND CUT 6MM DIA. BUR	51
M60R	MED ROUND CARBIDE BUR	51
MC5057	LINVATEC UNIVERSAL CABLE	7
N9150	MICROHUB FESS SHVR 4.2MM LYNX IRRIG 6 EA	55
N9210	4.2MM STRAIGHT FESS CUDA® 6 EA	55
N9220	4.2MM STRAIGHT FESS GATOR® BLADE 6 EA	56
N9320	HEAD AND NECK BLADE, 3.5MM, 7.0CM WORKING LENGTH, 6/BOX	56
N9321	HEAD AND NECK BLADE, 4.2MM, 11.5CM WORKING LENGTH, 6/BOX	56
N9330	4.2MM MICRO XCISOR ETHMOID CUTTER 6 EA	55
N9370	RHINOTEC® VORTEX® ROUTER, 4.5MM, HOODED, 10.8CM WORKING LENGTH, 6/BOX	57
N9375	4.5MM FESS 45 DEGREE VORTEX ROUTER 6 EA	57
N9380	4.5MM FESS SPHERICAL BURR 6 EA	58
N9382	RHINOTEC SPHERICAL BUR, 3.5MM, UNHOODED, 7.6CM WORKING LENGTH, 6/BOX	58

Cat. No.	Description	Page No.
N9385	RHINOTEC SPHERICAL DIAMOND BUR, 3.5MM, HOODED, 10.8CM WORKING LENGTH, 6/BOX	58
N9390	4.0MM HOODED OTOIARYNGOLOGY BURR 6 EA	57
PRO2000	POWERPRO® 115V CONSOLE	7
PRO2029	POWERPRO TRINKLE/AO DRILL ATTACHMENT	13
PRO2030	POWERPRO 5/32 JACOBS CHUCK ATTACHMENT	13
PRO2033	POWERPRO HIGH SPEED DRILL ATTACHMENT	13
PRO2038	POWERPRO AO SMALL ATTACHMENT	13
PRO2039	POWERPRO MINI AO ATTACHMENT	13
PRO2040	POWERPRO AO REAMER ATTACHMENT	13
PRO2041	POWERPRO 1/4 JACOBS CHUCK ATTACHMENT	13
PRO2042	POWERPRO 1/4 HIGH TORQUE JACOBS CHUCK	13
PRO2043	POWERPRO SAGITTAL SAW ATTACHMENT	13
PRO2045	POWERPRO RECIPROCATING SAW ATTACHMENT	13
PRO2046	POWERPRO ZIMMER/HUDSON DRILL ATTACHMENT	13
PRO2047	POWERPRO ZIMMER/HUDSON REAMER ATTACHMENT	13
PRO2060	POWERPRO AESCULAP REAMER ATTACHMENT	13
PRO2065	STD HUDSON REAMER	13
PRO2070	POWERPRO AO DRILL ATTACHMENT	13
PRO2075	STD HUDSON DRILL	13
PRO2080	POWERPRO DHS REAMER ATTACHMENT	13
PRO2250	POWERPRO 1/4 IN. KEYLESS CHUCK	13
PRO2329	POWERPRO TRINKLE REAMER ATTACHMENT	13
PRO2514	POWERPRO RADIOLUCENT DRIVE ADAPTOR	13
PRO3010	POWERPRO BATTERY STANDARD LARGE BATTERY	6
PRO3011	POWERPROMAX LARGE 12 VOLTS NICAD BATTERY	6
PRO3020	POWERPRO BATTERY STANDARD SMALL BATTERY	6
PRO3030	POWERPRO TRAUMA BATTERY	6
PRO3110	POWERPRO STERILE TRANSFER BATTERY CASE LG	6
PRO3115	POWERPRO STERILE TRANSFER BATTERY LARGE	6
PRO3130	POWERPRO STERILE TRANSFER SHROUD	6
PRO3135	POWERPRO BATTERY STERILE TRANSFER PLATFM	6
PRO3520	SMALL 12V STERILE TRANSFER BAT CELL PACK	6
PRO3521	SMALL 12V STERILE TRANSFER BATTERY CASE	6
PRO3531	SMALL 12V STERILE TRANSFER BATTERY SHROUD	6
PRO3535	SM 12V STERILE TRANSFER CHARGE PLATFORM	6
PRO3600	POWERPRO BATTERY CHARGER UNIVERSAL VOLT	6
PRO5095	POWERPRO SYSTEM STERILIZATION CASE SMALL	23
PRO5100M	POWERPRO MAX SINGLE TRIGGER BATTERY HP	10
PRO5128	LARGE SNGL TRIGGER WIRE DRIVER	10
PRO5132-4	POWERPRO MAX SINGLE TRIGGER 4MM PIN DRIVR	10
PRO5200M	POWERPRO MAX TWO TRIGGER FULL FUNCTION HP	10
PRO5228	POWERPRO BATTERY WIRE DRIVER ATTACHMENT	10
PRO5232-4	POWERPRO MAX 2-TRIGGER 4MM PIN DRIVER	10
PRO5250M	POWERPRO MAX TWO TRIGGER STANDARD HP	10
PRO5300M	POWERPRO MAX OSCILLATOR HP	10
PRO5400M	POWERPRO MAX RECIPROCATOR SAW HP	10
PRO6000	SMALL HALL STERILIZATION TRAY	23
PRO6040	POWERPRO 5:1 AO ASIF REAMER ATTACHMENT	13
PRO6042	POWERPRO 5:1 JACOBS REAMER ATTACHMENT	13
PRO6045	POWERPRO PRO6045 RECIPROCATOR ATTACHMENT	13
PRO6047	POWERPRO 5:1 ZIMMER HUDSON REAMER ATTACH	13
PRO6048	POWERPRO 5:1 HUDSON REAMER ATTACHMENT	13
PRO6050	POWERPRO 1/8 IN. KEYLESS CHUCK	13
PRO6060	POWERPRO 5:1 AESCULAP REAMER ATTACHMENT	13
PRO6100	POWERPRO ELECTRIC II MODULAR	11
PRO6125	POWERPRO ELECTRIC II OSCILLATOR	11
PRO6128	SMALL SINGLE TRIGGER WIRE DRIVER	9, 11, 12
PRO6135	POWERPRO ELECTRIC II RECIPROCATOR	11
PRO6140	SINGLE TRIGGER 4MM PIN DRIVER	9, 11, 12

Numerical Index



Cat. No.	Description	Page No.
PRO6150	POWERPRO PNEUMATIC MODULAR	12
PRO6175	POWERPRO® PNEUMATIC OSCILLATOR	12
PRO6185	POWERPRO PNEUMATIC RECIPROCATOR HANDPCE	12
PRO6200M	MPOWER® 2 1 TRIGGER MODULAR HANDPIECE	9
PRO6202M	MPOWER 2 2-TRIGGER FULL FUNC MOD HANDPIEC	9
PRO6228	SMALL TWO TRIGGER WIRE DRIVER	9
PRO6240	MPOWER 2 1 TRIGGER MODULAR HANDPIECE	9
PRO6350M	MPOWER 2 OSCILLATING SAW HANDPIECE	9
PRO6400M	MPOWER 2 RECIPROCATING SAW	9
PRO6450M	MPOWER 2 STERNUM SAW	20
PRO7020	PRO7020 ATTACHMENT	13
T100	STAPLIZER HANDPC	22
T107	7MM STAPLE CARRIER	22
T110	10MM STAPLE CARRIER	22
T113	13MM STAPLE CARRIER	22
T116	16MM STAPLE CARRIER	22
T121	STAPLE PRY	22
T122	STAPLER SEATER	22
T123	STAPLIZR WIDE GAUG ASY	22
T210	STAPLIZER AUTOCLV CASE	22
T301	PUNCH REMOVAL TOOL ASSY	22
T307	7MM STAPLIZER DRILL GUIDE	22
T310	10MM STAPLIZER DRILL GUID	22
T313	13MM STAPLIZER DRILL GUID	22
T316	16MM STAPLIZER DRILL GUID	22
X10D	X-LONG ROUND DIA BUR	51
X40B	X-LONG BARREL CAR BUR	52
X45C	X-LONG CONE CARBIDE BUR	53
X55B	XLG,BRL OVAL, 5.5 X10 BUR	52
X60R	X-LONG ROUND CARBIDE BUR	51

Cat. No.	Description	Page No.
5044-999-52	1/4 IN. JACOBS CHUCK KEY REPLACEMENT	13
7010-03	10 X 10 STAPLIZER CARTRIDGE 3 EA	54
7015-03	10 X 15 STAPLIZER CARTRIDGE 3 EA	54
7007-03	10 X 7 STAPLIZER CARTRIDGE 3 EA	54
T110	10MM STAPLE CARRIER	22
T310	10MM STAPLIZER DRILL GUID	22
7310-03	13 X 10 STAPLIZER CARTRIDGE 3 EA	54
7315-03	13 X 15 STAPLIZER CARTRIDGE 3 EA	54
7320-03	13 X 20 STAPLIZER CARTRIDGE 3 EA	54
7307-03	13 X 7 STAPLIZER CARTRIDGE 3 EA	54
T113	13MM STAPLE CARRIER	22
T313	13MM STAPLIZER DRILL GUID	22
7610-03	16 X 10 STAPLIZER CARTRIDGE 3 EA	54
7615-03	16 X 15 STAPLIZER CARTRIDGE 3 EA	54
7620-03	16 X 20 STAPLIZER CARTRIDGE 3 EA	54
7625-03	16 X 25 STAPLIZER CARTRIDGE 3 EA	54
T116	16MM STAPLE CARRIER	22
T316	16MM STAPLIZER DRILL GUID	22
A101	20 FOOT HOSE	22
5023-057	25 X 6.3 X 3.8 LATERAL 70 DEGREES	48
5023-056	25 X 6.3 X 3.8 MEDIAL 25 DEGREES	48
5023-055	25 X 6.3 X 3.8 STRAIGHT	48
C9863	3-PEDAL FOOTSWITCH	7
E9363	3.7MM LARYNGEAL BLADE	56
N9390	4.0MM HOODED OTOIARYNGOLOGY BURR 6 EA	57
N9330	4.2MM MICRO XCISOR ETHMOID CUTTER 6 EA	55
E9350	4.2MM RHINOTEC® FESS BLADE CUDA ENT 6 EA	55
E9360	4.2MM RHINOTEC FESS BLD GATOR ENT 6 EA	56
N9210	4.2MM STRAIGHT FESS CUDA 6 EA	55
N9220	4.2MM STRAIGHT FESS GATOR BLADE 6 EA	56
N9375	4.5MM FESS 45 DEGREE VORTEX ROUTER 6 EA	57
N9380	4.5MM FESS SPHERICAL BURR 6 EA	58
5044-999-53	5/32 IN. JACOBS CHUCK KEY REPLACEMENT	13
7021-229	6.0/MDS M-33 ST ULTRAPOWER® B	61
7710-03	7 X 10 STAPLIZER CARTRIDGE 3 EA	54
7707-03	7 X 7 STAPLIZER CARTRIDGE 3 EA	54
T107	7MM STAPLE CARRIER	22
T307	7MM STAPLIZER DRILL GUIDE	22
5039-003	AC POWER CORD	7
C8806	ACL BLADE, FINE, STRAIGHT, 10.0 FREEHAND, 9.4 X 41.0MM	47
C8804	ACL BLADE, FINE, STRAIGHT, 8.0 FREEHAND, 9.4 X 41.0MM	47
C8803	ACL BLADE, FINE, STRAIGHT, 8.0 WITH GUIDE/12 WITHOUT GUIDE, 9.4 X 41.0MM	47
D3000	ADVANTAGE® CONSOLE	7
1375-034	ANGLE ATTACH 70D W/DENTAL NSK	14
1375-032	ANGLE ATTACHMENT 20D NSK	14, 51, 53
1375-036	ANGLE ATTACHMENT 90D NSK	14, 51, 52
1375-033	ANGLE ATTACHMENT XLONG 20D NSK	14, 53
1375-035	ANGLE ATTACHMENT, 70D CONTRA ANGLE NS	14, 51, 52
1375-037	ATTACHMENT LUBRICANT	8
5052-012	AUTOCLAVE CASE	19, 23, 24
1384-042	AUTOCLAVE CASE, LARGE	23
M105A	BLITZ® CLEANER AND LUBRIC	8
1375-015	BUR BRUSH	23, 24, 26, 27
1375-003	BUR CHANGER	14
5020-160	BUR GUARD SLEEVE MICROCHOICE® 30/BX	16
1375-112	BUR GUARD SLEEVE SURGAIRTOME II® -1 EACH IS A BOX OF 30	16
1375-023	BUR GUARD, CLOWARD X-LONG	14, 51 - 53
1375-011	BUR GUARD, LONG	14, 51 - 53
1375-012	BUR GUARD, MEDIUM	14, 24, 51 - 53

Alphabetical Index



Cat. No.	Description	Page No.
E9324	BUR RACK, FOLDING, HOLDS UP TO 26 BURS FOR E9010 DRILL	17
5050-041	C-WIRE™ - .028 IN. SPADE TIP	54
5050-046	C-WIRE - .028 IN. TROCAR TIP	54
5050-042	C-WIRE - .035 IN. SPADE TIP	54
5050-047	C-WIRE - .035 IN. TROCAR TIP	54
5050-043	C-WIRE - .045 IN. SPADE TIP	54
5050-048	C-WIRE - .045 IN. TROCAR TIP	54
5050-044	C-WIRE - .062 IN. SPADE TIP	54
5050-049	C-WIRE - .062 IN. TROCAR TIP	54
5052-049	CEBOTOME® BUR EXTENSION, LONG THIN	21
5052-048	CEBOTOME BUR EXTENSION, MEDIUM THIN	21, 27
5052-142	CEBOTOME METAL CUTTING BUR EXTENSION	21, 27
5052-143	CEBOTOME METAL CUTTING BUR WRENCH	21, 27
5052-125	CEBOTOME METAL CUTTING WHEEL	27, 67
5052-129	CEBOTOME METAL CUTTING WHEEL WRENCH	27
5052-126	CEBOTOME METAL TRIMMING WHEEL	27, 67
5052-041	CEBOTOME REVISION DRILL W/O HOSE	21, 27
5052-042	CEBOTOME SHORT BUR EXTENSION	21, 27
5052-046	CEBOTOME WRENCH	21, 27
E9322	CLEANING BRUSHES	17
5091-083	DERMABRADER BUR, DIAMOND, MED, TAPERED,	51
5091-082	DERMABRADER BUR, DIAMOND, MEDIUM, STR, 12	51
5091-080	DERMABRADER BUR, DIAMOND, MEDIUM, STR, 4	51
5091-081	DERMABRADER BUR, DIAMOND, MEDIUM, STR, 7	51
5092-247	DISP WIRE PASS STEEL BUR, 1.0 X 19, LONG, 5 EA	51
5037-033	DISPOSABLE FILTERS 1000 PER BOX	23
M322	DISS TO SCHRADER ADAPT	8
M208	DUAL NITROGEN REGULATOR	8
E5120	E9000® BUR RND DIAMOND CRS 2.0 X 38MM STERI	59
E5225	E9000 BUR RND DIAMOND CRS 2.5X48MM STERI	59
E5160	E9000 BUR RND DIAMOND CRS 3.0 X 38MM STERI	59
E5140	E9000 BUR RND DIAMOND CRS 4.0 X 38MM STERI	59
E5150	E9000 BUR RND DIAMOND CRS 5.0 X 38MM STERI	59
E8105	E9000 BUR ROUND 0.5 X 38MM STERILE	59
E8110	E9000 BUR ROUND 1.0 X 38MM STERILE	59
E8115	E9000 BUR ROUND 1.5 X 38 MM STERILE	59
E8120	E9000 BUR ROUND 2.0 X 38MM STERILE	59
E8125	E9000 BUR ROUND 2.5 X 38MM STERILE	59
E8265LSO	E9000 BUR ROUND 6.5 X 48MM STERILE	59
E6105	E9000 BUR ROUND DIAMOND 0.5 X 38MM STERILE	59
E6110	E9000 BUR ROUND DIAMOND 1.0 X 38MM STERILE	59
E6115	E9000 BUR ROUND DIAMOND 1.5 X 38MM STERILE	59
E6120	E9000 BUR ROUND DIAMOND 2.0 X 38MM STERILE	59
E6125	E9000 BUR ROUND DIAMOND 2.5 X 38MM STERILE	59
E6225	E9000 BUR ROUND DIAMOND 2.5 X 48MM STERILE	59
E6130	E9000 BUR ROUND DIAMOND 3.0 X 38MM STERILE	59
E9000	E9000 CONSOLE 115 VOLT	7
E9015	E9000 CRANIAL PERFORATOR DRIVE	17
E9010	E9000 HIGH SPEED DRILL	17
E9005	E9000 HIGH SPEED SHAVER	17
E9011-2	E9000 LONG BUR GUARD	17, 59, 60
E9011-9	E9000 LONG NEURO GUARD	17, 60
E9011-1	E9000 MEDIUM BUR GUARD	17, 59, 60
E9011-8	E9000 MEDIUM NEURO GUARD	17, 60
E9011-7	E9000 SHORT NEURO GUARD	17, 60
7021-960	E9000 ULTRAPOWER® BUR SIDE CUTTING LONG	60
E9011-3	E9000 XL BUR GUARD	17
E9323	E9000,ACCESSORY,BUR RACK	17
5059-011	EXTENDED STERNUM SAW BLADE GUARD	20

Cat. No.	Description	Page No.
5052-018	EXTENSION HOSE, 10'	8
5052-029	EXTENSION HOSE, 10' WITH DISS CONNECTOR	8
5052-030	EXTENSION HOSE, 15'	8
5052-031	EXTENSION HOSE, 20'	8
1365-016	HALL® LUBRICANT	8
N9320	HEAD AND NECK BLADE, 3.5MM, 7.0CM WORKING LENGTH, 6/BOX	56
N9321	HEAD AND NECK BLADE, 4.2MM, 11.5CM WORKING LENGTH, 6/BOX	56
1365-005	HEX WRENCH	16
A201	HOSE W/FULL AIR RETURN	8, 22
5071-345	INTREX® BLADE 12.5 X 90 X 1.37, 5 EA	28
5071-340	INTREX BLADE 12.5 X 90 X 0.89, 5 EA	28
5071-341	INTREX BLADE 12.5 X 90 X 1.00, 5 EA	28
5071-342	INTREX BLADE 12.5 X 90 X 1.07, 5 EA	28
5071-343	INTREX BLADE 12.5 X 90 X 1.19, 5 EA	28
5071-344	INTREX BLADE 12.5 X 90 X 1.27, 5 EA	28
5071-346	INTREX BLADE 12.5 X 90 X 1.47, 5 EA	28
5071-350	INTREX BLADE 13 X 8 X 70 X 0.89, 5 EA	28
5071-355	INTREX BLADE 13 X 8 X 70 X 0.137, 5 EA	28
5071-352	INTREX BLADE 13 X 8 X 70 X 1.07, 5 EA	28
5071-353	INTREX BLADE 13 X 8 X 70 X 1.19, 5 EA	28
5071-354	INTREX BLADE 13 X 8 X 70 X 1.27, 5 EA	28
5071-356	INTREX BLADE 13 X 8 X 70 X 1.47, 5 EA	28
5071-351	INTREX BLADE 13 X 8 X 070 X 01.00, 5 EA	28
5071-300	INTREX BLADE 19.5 X 90 X 0.89, 5 EA	28
5071-301	INTREX BLADE 19.5 X 90 X 1.00, 5 EA	28
5071-302	INTREX BLADE 19.5 X 90 X 1.07, 5 EA	28
5071-303	INTREX BLADE 19.5 X 90 X 1.19, 5 EA	28
5071-304	INTREX BLADE 19.5 X 90 X 1.27, 5 EA	28
5071-305	INTREX BLADE 19.5 X 90 X 1.37, 5 EA	28
5071-306	INTREX BLADE 19.5 X 90 X 1.47, 5 EA	68, 69
5071-310	INTREX BLADE 25 X 9 X 90 X 0.89, 5 EA	28
5071-311	INTREX BLADE 25 X 9 X 90 X 1.00, 5 EA	28
5071-312	INTREX BLADE 25 X 9 X 90 X 1.07, 5 EA	28
5071-313	INTREX BLADE 25 X 9 X 90 X 1.19, 5 EA	28
5071-314	INTREX BLADE 25 X 9 X 90 X 1.27, 5 EA	28
5071-315	INTREX BLADE 25 X 9 X 90 X 1.37, 5 EA	28
5071-316	INTREX BLADE 25 X 9 X 90 X 1.47, 5 EA	28
5071-330	INTREX BLADE 25.0 X 100 X 0.89, 5 EA	28
5071-331	INTREX BLADE 25.0 X 100 X 1.00, 5 EA	28
5071-332	INTREX BLADE 25.0 X 100 X 1.07, 5 EA	28
5071-333	INTREX BLADE 25.0 X 100 X 1.19, 5 EA	28
5071-334	INTREX BLADE 25.0 X 100 X 1.27, 5 EA	28
5071-335	INTREX BLADE 25.0 X 100 X 1.37, 5 EA	28
5071-336	INTREX BLADE 25.0 X 100 X 1.47, 5 EA	28
5071-320	INTREX BLADE 25.0 X 90 X 0.89, 5 EA	28
5071-321	INTREX BLADE 25.0 X 90 X 1.00, 5 EA	28
5071-322	INTREX BLADE 25.0 X 90 X 1.07, 5 EA	28
5071-323	INTREX BLADE 25.0 X 90 X 1.19, 5 EA	28
5071-324	INTREX BLADE 25.0 X 90 X 1.27, 5 EA	28
5071-325	INTREX BLADE 25.0 X 90 X 1.37, 5 EA	28
5071-326	INTREX BLADE 2530 X 90 X 1.47, 5 EA	28
5040-180	IRRIGATION BAG SUPPORT ROD	7
1375-020	LAMINECTOMY BUR GUARD	14 – 52
5052-281	LARGE BONE RECIPIENT, 9.4 X 54.5 X 1.5MM 5 EA	44
PRO5128	LARGE SINGL TRIGGER WIRE DRIVER	10
5071-548	LG BN OSC 12.7X86.0X1.19, 1.19MM 5 EA	29, 31
5071-547	LG BN OSC 25.4 X 86.0 X 1.19, 1.19MM 5 EA	29, 32
5071-236	LG BN OSC 9.12 X 25.22 X 0.64, 0.64MM 5 EA	39
5071-557	LG BN OSC BLD 12.5 X 73.8 X 0.63, 1.06MM 5 EA	40, 42

Alphabetical Index



Cat. No.	Description	Page No.
5071-568	LG BN OSC BLD 16.5 X 95 X 1.27 X 1.27MM 5 EA	29, 34
5071-558	LG BN OSC BLD 18.5 X 73 X 1.24MM 5 EA	29, 32
5071-590	LG BONE OSC BLADE 13 X 95 X 1.27 X 1.27MM 5 EA	29, 34
5071-519	LG BONE OSC BLADE 21 X 95 X 1.27 X 1.27MM 5 EA	29, 34
5071-571	LG BONE OSC BLD 9.5 X 30 X 0.64 X 0.84MM 5 EA	39
L55B	LG,BR OVALCUT,5.5 X 10 CABUR	52
5052-291	LGBN BLD RECIP COATED,12.5 X 76 X 1.2MM	44
E4217	LINDEMANN 1.6X31 STERILE	60
MC5057	LINVATEC UNIVERSAL CABLE	7
E9012	LOCKING COLLAR FOR E9010 DRILL	17
L40B	LONG BARREL CARBIDE BUR	52
L45C	LONG CONE CARBIDE BUR	53
L18R	LONG ROUND CARBIDE BUR	51
L23R	LONG ROUND CARBIDE BUR	51
L60R	LONG ROUND CARBIDE BUR	51
L10D	LONG ROUND DIAMOND BUR	51
L13S	LONG STRAIGHT CARBID BUR	52
L17S	LONG STRAIGHT CARBIDE BUR	52
L17T	LONG TAPERED CARB BUR	52
L20T	LONG TAPERED CARB BUR	52
L12T	LONG TAPERED CARBD BUR	52
5071-570-50	LRG BN OSC BLD STERILE 25 X 95 X 1.24MM 5 EA	29, 32
M317	LUBRICANT FOR AIR DRIVER	8
M40B	MED BARRELL CARBIDE BUR	52
M55B	MED BRL OVALCUT 5.5 X 10 BUR	52
M45C	MED CONE CARBIDE BUR	53
M60D	MED RND CUT 6MM DIA. BUR	51
M60R	MED ROUND CARBIDE BUR	51
M15S	MED ST SID CT 1.5 X 7.5 BUR	52
M20S	MED ST SID CUT 2 X 10 CAR BUR	52
M10S	MED STR SID CUT 1 X 5 BURR	52
M17S	MED STRAIGHT CARB BUR	52
M13S	MED STRAIGHT CARBIDE BUR	52
M15T	MED TAP SID CUT 1.5 X 10 BU	52
M10T	MED TAPERED CARBIDE BUR	52
M12T	MED TAPERED CARBIDE BUR	52
M20T	MED TAPERED CARBIDE BUR	52
5053-009	MICRO 100™ DRILL W/O HOSE	16
1375-028	MICRO 100 FOOT CONTROL	8
5053-012	MICRO 100 OSCILLATOR SAW W/O HOSE	16
5053-022	MICRO 100 OSCILLATOR SAW,X-LONG W/O HOSE	16
5053-010	MICRO 100 RECIPROCATOR SAW W/O HOSE	16
5053-011	MICRO 100 SAGITTAL SAW W/O HOSE	16
5053-013	MICRO 100 WIREDRIVER W/O HOSE	16
5053-083	MICRO RECIP RASP LARGE CROSS CUT STERILE	50
5053-085	MICRO RECIP RASP LARGE INTRAMED STERILE	50
5053-081	MICRO RECIP RASP LARGE STRAIGHT STERILE	50
5053-082	MICRO RECIP RASP SMALL CROSS CUT STERILE	50
5053-084	MICRO RECIP RASP SMALL INTRAMED STERILE	50
5053-080	MICRO RECIP RASP SMALL STRAIGHT STERILE	50
5053-051	MICRO RECIPROCATING SAW BLADE, 17 X 4MM	50
5053-052	MICRO RECIPROCATING SAW BLADE, 23 X 5MM	50
5053-053	MICRO RECIPROCATING SAW BLADE, 25 X 7MM	50
5053-054	MICRO RECIPROCATING SAW BLADE, 25 X 8MM	50
5053-050	MICRO RECIPROCATING SAW BLADE, 7 X 5MM	50
5023-134	MICRO SAG SAW BLADE FINE 5.5 X 9 X .6MM 5 EA	47
5023-136	MICRO SAG SAW BLD FINE 14 X 15.5 X .6MM 5 EA	47
5044-145	MICRO SAGL BLADE 10 X 18.5 X .4MM FINE 5 EA	46
5092-271	MICRO TAPERD FISSURE BUR LONG STER 5 EA	53

Cat. No.	Description	Page No.
5092-272	MICRO TAPERD FISSURE BUR LONG STER 5 EA	53
5092-273	MICRO TAPERD FISSURE BUR LONG STER 5 EA	53
5091-213	MICRO TAPERD FISSURE BUR MED STER 5 EA	53
5091-271	MICRO TAPERD FISSURE BUR MED STER 5 EA	53
5091-272	MICRO TAPERD FISSURE BUR MED STER 5 EA	53
5023-244	MICROBLADE SAG 4 X 6 X .4MM FLAT FINE 5 EA	46
5020-053	MICROCHOICE® FOOT CONTROL	7
5020-054	MICROCHOICE POLE MOUNT	7
E9418	MICROCHOICE TUBING W/IRRIGATN E9000 5 EA	14
N9150	MICROHUB FESS SHVR 4.2MM LYNX IRRIG 6 EA	55
6021-025	MICROPOWER® HS DRILL PERM LEVER ORAL MAX	15
6021-026	MICROPOWER HS DRILL PERM LEVER ORTHO	15
6020-026	MICROPOWER HS DRILL REMOVE LEVER ORTHO	15
6020-025	MICROPOWER HS DRILL REMOVE LIVR ORAL MAX	15
6021-021	MICROPOWER MEDIUM SPD DRILL PERM LEVER	15
6020-021	MICROPOWER MEDIUM SPD DRILL REMOVE LEVER	15
6021-024	MICROPOWER OSCILLATING SAW PERM LEVER	15
6020-024	MICROPOWER OSCILLATING SAW REMOVE LEVER	15
6021-023	MICROPOWER RECIPROCATING SAW PERM LEVER	15
6020-023	MICROPOWER RECIPROCATING SAW REMOVE LEVR	15
6021-022	MICROPOWER SAGITTAL SAW PERMANENT LEVER	15
6020-022	MICROPOWER SAGITTAL SAW REMOVE LEVER	15
5144-002	MODIFIED SCHRADER COUPLER	8
PRO6200M	MPOWER® 2 1 TRIGGER MODULAR HANDPIECE	9
PRO6240	MPOWER 2 1 TRIGGER MODULAR HANDPIECE	9
PRO6202M	MPOWER 2 2-TRIGGER FULL FUNC MOD HANDPIEC	9
PRO6350M	MPOWER 2 OSCILLATING SAW HANDPIECE	9
PRO6400M	MPOWER 2 RECIPROCATING SAW	9
PRO6450M	MPOWER 2 STERNUM SAW	20
M207	NITROGEN REGULATOR S/N	8
5059-032	NON-STERILE STERNUM SAW BLADE	68
5059-032-01	NON-STERILE BULK PACK STERNUM SAW BLADE	68
5071-538	OSC 25.4 X 95 X 1.0 X 1.0MM TAPER STERL 5 EA	29, 31
5071-161	OSC BLADE 25.4 X 90 X 1.27MM 5 EA	29, 34
5071-246	OSC BLADE FINE 5.5 X 25.5 X 0.6MM 5 EA	39
5071-532	OSC BLD 12 X 80 X 0.9 X 0.9MM STERILE 5 EA	29, 30
5071-582	OSC BLD 13 X 90 X 1.27 X 1.27MM STERILE 5 EA	33
5071-526	OSC BLD 18.5 X 107 X 1.24 X 1.24MM STERILE 5 EA	29, 32
5071-527	OSC BLD 19 X 80 X 1.27 X 1.27MM STERILE 5 EA	29, 33
5071-525	OSC BLD 19 X 95 X 1.37 X 1.37MM STERILE 5 EA	29, 35
5071-531	OSC BLD 25.4 X 85 X 1.27 X 1.27MM STERILE 5 EA	29, 33
5071-583	OSCBLD 12.7 X 90 X 0.89 X 0.89MM STERILE 5 EA	29, 30
5071-589	OSCBLD 13 X 90 X 0.89 X 0.89MM STERILE 5 EA	29, 30
5071-530	OSCBLD 19 X 95 X 1.37 X 1.37MM STERILE 5 EA	29, 35
5071-129	OSCBLD 19.5 X 105 X 1.27 X 1.27MM STERILE 5 EA	29, 35
5071-529	OSCBLD 19.5 X 105 X 1.27 X 1.27MM STERILE 5 EA	29, 35
5071-533	OSCBLD 21 X 84.5 X 0.89 X 0.89MM STERILE 5 EA	29, 30
5071-528	OSCBLD 25 X 73 X 0.89 X 0.89MM STERILE 5 EA	29, 30
5071-534	OSCBLD 25.4 X 79.5 X 1.24 X 1.24MM STERIL 5 EA	29, 32
5071-562	OSCBLD 25.4 X 90 X 1.0 X 1.0MM STERILE 5 EA	29, 31
5071-564	OSCBLD 25.4 X 90 X 1.27 X 1.27MM STERILE 5 EA	29, 34
5071-565	OSCBLD 25.4 X 90 X 1.47 X 1.47MM STERILE 5 EA	29, 35
5071-560	OSCBLD 25.4 X 95 X 0.86 X 1.0MM STERILE 5 EA	40, 42
5071-594	OSCBLD 29.46 X 58.7 X 0.64 X 0.64MM STER 5 EA	29, 30
5071-539	OSCILLATING BLADE 25.4 X 95 X 1.37 NONSTERIL	29, 35
5038-002	OSTEON ANGLED HANDPIECE W/O HOSE	19, 26, 27
5038-009	OSTEON BUR RACK	19, 26, 27
5056-083	OSTEON BUR, DERMABRADER, DIAMOND, 10 X 3	66
5056-082	OSTEON BUR, DERMABRADER, DIAMOND, 12.0	66

Alphabetical Index



Cat. No.	Description	Page No.
5056-080	OSTEON BUR, DERMABRADER, DIAMOND, 4.0	66
5056-081	OSTEON BUR, DERMABRADER, DIAMOND, 7.0	66
5056-178	OSTEON BUR. STEEL ROUND, 2.0 X 30M	66
5038-004	OSTEON FOOT CONTROL WITH HOSE	19, 26, 27
5038-005	OSTEON HOSE	19, 26, 27
5038-600	OSTEON IRRIGATION TUBING 5/BOX	19
5038-001	OSTEON STRAIGHT HANDPIECE W/O HOSE	19, 26, 27
A9350	OTOLARYNGOLOGY BLADE 4.2MM CUDA 6 EA	55
A9360	OTOLARYNGOLOGY BLADE 4.2MM GATOR 6 EA	56
5056-003	OTOTOME FOOT CONTROL	19
5056-002	OTOTOME MOTOR WITH 10 FOOT HOSE	26
PRO2042	POWERPRO® 1/4 HIGH TORQUE JACOBS CHUCK	13
PRO2250	POWERPRO 1/4 IN. KEYLESS CHUCK	13
PRO2041	POWERPRO 1/4 JACOBS CHUCK ATTACHMENT	13
PRO6050	POWERPRO 1/8 IN. KEYLESS CHUCK	13
PRO2000	POWERPRO 115V CONSOLE	7
PRO6060	POWERPRO 5:1 AESCULAP REAMER ATTACHMENT	13
PRO6040	POWERPRO 5:1 AO ASIF REAMER ATTACHMENT	13
PRO6048	POWERPRO 5:1 HUDSON REAMER ATTACHMENT	13
PRO6042	POWERPRO 5:1 JACOBS REAMER ATTACHMENT	13
PRO6047	POWERPRO 5:1 ZIMMER HUDSON REAMER ATTACH	13
PRO2030	POWERPRO 5/32 JACOBS CHUCK ATTACHMENT	13
PRO2060	POWERPRO AESCULAP REAMER ATTACHMENT	13
PRO2070	POWERPRO AO DRILL ATTACHMENT	13
PRO2040	POWERPRO AO REAMER ATTACHMENT	13
PRO2038	POWERPRO AO SMALL ATTACHMENT	13
PRO3600	POWERPRO BATTERY CHARGER UNIVERSAL VOLT	6
PRO3010	POWERPRO BATTERY STANDARD LARGE BATTERY	6
PRO3020	POWERPRO BATTERY STANDARD SMALL BATTERY	6
PRO3135	POWERPRO BATTERY STERILE TRANSFER PLATFM	6
PRO5228	POWERPRO BATTERY WIRE DRIVER ATTACHMENT	10
PRO2080	POWERPRO DHS REAMER ATTACHMENT	13
PRO6100	POWERPRO ELECTRIC II MODULAR	11
PRO6125	POWERPRO ELECTRIC II OSCILLATOR	11
PRO6135	POWERPRO ELECTRIC II RECIPROCATOR	11
PRO2033	POWERPRO HIGH SPEED DRILL ATTACHMENT	13
PRO2039	POWERPRO MINI AO ATTACHMENT	13
PRO6150	POWERPRO PNEUMATIC MODULAR	12
PRO6175	POWERPRO PNEUMATIC OSCILLATOR	12
PRO6185	POWERPRO PNEUMATIC RECIPROCATOR HANDPCE	12
PRO6045	POWERPRO PRO6045 RECIPROCATOR ATTACHMENT	13
PRO2514	POWERPRO RADIOLUCENT DRIVE ADAPTOR	13
PRO2045	POWERPRO RECIPROCATING SAW ATTACHMENT	13
PRO2043	POWERPRO SAGITTAL SAW ATTACHMENT	13
PRO3115	POWERPRO STERILE TRANSFER BATTERY LARGE	6
PRO3110	POWERPRO STERILE TRANSFER BATTERY CASE LG	6
PRO3130	POWERPRO STERILE TRANSFER SHROUD	6
PRO5095	POWERPRO SYSTEM STERILIZATION CASE SMALL	23
PRO3030	POWERPRO TRAUMA BATTERY	6
PRO2029	POWERPRO TRINKLE/AO DRILL ATTACHMENT	13
PRO2046	POWERPRO ZIMMER/HUDSON DRILL ATTACHMENT	13
PRO2047	POWERPRO ZIMMER/HUDSON REAMER ATTACHMENT	13
PRO5232-4	POWERPRO MAX 2-TRIGGER 4MM PIN DRIVER	10
PRO3011	POWERPRO MAX LARGE 12 VOLTS NICAD BATTERY	6
PRO5300M	POWERPRO MAX OSCILLATOR HP	10
PRO5400M	POWERPRO MAX RECIPROCATOR SAW HP	10
PRO5132-4	POWERPRO MAX SINGLE TRIGGER 4MM PIN DRIVR	10
PRO5100M	POWERPRO MAX SINGLE TRIGGER BATTERY HP	10
PRO5200M	POWERPRO MAX TWO TRIGGER FULL FUNCTION HP	10

Cat. No.	Description	Page No.
PRO5250M	POWERPRO® MAX TWO TRIGGER STANDARD HP	10
PRO2329	POWERPRO TRINKLE REAMER ATTACHMENT	13
2075-017	PRESSURE TESTER	8
5271-580	PRIMECUT® OSCBLD 10 X 85 X 1.27 X 1.27 ST 5 EA	29, 33
5271-561	PRIMECUT OSCBLD 25.4 X 90 X 1.27 X 1.27MM 5 EA	29, 34
5271-502	PRIMECUT OSCBLD 29 X 74 X 0.64 X 0.64 ST 5 EA	29, 30
PRO7020	PRO7020 ATTACHMENT	13
T301	PUNCH REMOVAL TOOL ASSY	22
5052-260	RECIPROCATOR BLADE 12.5 X 38.0MM 5 EA	44
5052-261	RECIPROCATOR BLADE 12.5 X 89.0MM 5 EA	44
5052-259	RECIPROCATOR BLADE 9.4 X 54.5MM 5 EA	44
5052-179	RECIPROCATOR BLADE, COATED, 12.5 X 76.0MM 5 EA	44
5052-258	RECIPROCATOR BLADE, 12.5 X 89MM 5 EA	44
5052-276	RECIPROCATOR BLADE, 13 X 48MM	44
5023-178	REPEAT STERNOTOMY BLADE 44.6MM 5 EA	68
5023-180	REPEAT STERNOTOMY BLADE 65.8MM 5 EA	69
5057-040	REPEAT STERNOTOMY SAW W/O HOSE	20
5040-158	REUSABLE 20D ANGLE BUR TIP	14
5040-159	REUSABLE X-LONG 20D BUR TIP	14
1375-021	RHINOPLASTY BUR GUARD	14 – 51
C9950	RHINOTEC® CUDA® BLADE, 2.0MM, 7.6CM WORKING LENGTH, 6/BOX	55
C9951	RHINOTEC CUDA BLADE, 2.9MM, 7.6CM WORKING LENGTH, 6/BOX	55
C9952	RHINOTEC CUDA BLADE, 3.5MM, 7.6CM WORKING LENGTH, 6/BOX	55
C9960	RHINOTEC GATOR® BLADE, 2.0MM, 7.6CM WORKING LENGTH, 6/BOX	56
C9961	RHINOTEC GATOR BLADE, 2.9MM, 7.6CM WORKING LENGTH, 6/BOX	56
C9962	RHINOTEC GATOR BLADE, 3.5MM, 7.6CM WORKING LENGTH, 6/BOX	56
C9911	RHINOTEC SPHERICAL BUR, 2.9MM, HOODED, 7.6CM WORKING LENGTH, 6/BOX	58
C9912	RHINOTEC SPHERICAL BUR, 3.5MM, HOODED, 7.6CM WORKING LENGTH, 6/BOX	58
N9382	RHINOTEC SPHERICAL BUR, 3.5MM, UNHOODED, 7.6CM WORKING LENGTH, 6/BOX	58
N9385	RHINOTEC SPHERICAL DIAMOND BUR, 3.5MM, HOODED, 10.8CM WORKING LENGTH, 6/BOX	58
E9351	RHINOTEC CUDA 3.7MM 6 EA	55
E9361	RHINOTEC GATOR 3.7MM 6 EA	56
C9990	RHINOTEC VORTEX® ROUTER, 2.9MM, HOODED, 7.6CM WORKING LENGTH, 6/BOX	57
C9991	RHINOTEC VORTEX ROUTER, 3.5MM, HOODED, 7.6CM WORKING LENGTH, 6/BOX	57
N9370	RHINOTEC VORTEX ROUTER, 4.5MM, HOODED, 10.8CM WORKING LENGTH, 6/BOX	57
E9315	SHAVER BLADE DE-CLOGGER NON-STERIL 6 EA	17
5092-204	SIDE CUT CBD BUR,LNG,STR 1.5 X 5.1MM 5 EA	52
5091-204	SIDE CUT CRBD BURS, MED, STR,1.5 X 5.1MM 5 EA	52
PRO6140	SINGLE TRIGGER 4MM PIN DRIVER	9, 11, 12
PRO3535	SM 12V STERILE TRANSFER CHARGE PLATFORM	6
PRO3520	SMALL 12V STERILE TRANSFER BAT CELL PACK	6
PRO3521	SMALL 12V STERILE TRANSFER BATTERY CASE	6
PRO3531	SMALL 12V STERILE TRANSFER BATTERY SHROUD	6
PRO6000	SMALL HALL STERILIZATION TRAY	23
PRO6128	SMALL SINGLE TRIGGER WIRE DRIVER	9, 11, 12
PRO6228	SMALL TWO TRIGGER WIRE DRIVER	9
6020-260	SMARTGUARD® IRRIGATOR SB IRRIG 30 PER BOX IS 1 EA	16
5023-185	ST ACL BLADE 6.5 X 30 X .6MM 5 EA	47
5023-186	ST ACL BLADE 8.5 X 38 X .4MM	47
5091-252	ST BARREL CUT CARBIDE BURS MED 5 EA	52
5091-254	ST BARREL CUT CARBIDE,BURS MED, 5 EA	52
5092-254	ST BARRELL CUT CARBIDE BUR, LONG, 4MM 5 EA	52
5092-252	ST BARRELL CUT CARBIDE BURS, LONG, 2MM 5 EA	52
5071-201	ST BLD, COATED, NEXGEN, 19.5 X 86 X 1.27	29, 33
7021-283	ST BUR ACORN 9.0/RPL MIDAS M-1	64
5093-282	ST BUR HVY GRIT DIAM. 2MM 5 EA	53
5092-282	ST BUR HVY GRIT DIAM. 2MM 5/BOX	53
5092-283	ST BUR HVY GRIT DIAM. 3MM 5 EA	53
5093-283	ST BUR HVY GRIT DIAM. 3MM 5 EA	53

Alphabetical Index



Cat. No.	Description	Page No.
5092-284	ST BUR HVY GRIT DIAM. 4MM 5 EA	53
5093-284	ST BUR HVY GRIT DIAM. 4MM 5 EA	53
5092-285	ST BUR HVY GRIT DIAM. 5MM 5 EA	53
5093-285	ST BUR HVY GRIT DIAM. 5MM 5 EA	53
5092-286	ST BUR HVY GRIT DIAM. 6MM 5 EA	53
5093-286	ST BUR HVY GRIT DIAM. 6MM 5 EA	53
7021-331	ST BUR RND 7.5/RPL MIDAS AM-32	61
7021-332	ST BUR RND 9.0/RPL MIDAS AM-31	61
5052-188	ST CEBOTOME® BUR, 10.0MM BARREL	67
5052-190	ST CEBOTOME BUR, 10.0MM ROUND	67
5052-189	ST CEBOTOME BUR, 5.0MM ROUND	67
5052-181	ST CEBOTOME BUR, 5MM SIDE CUTTING	67
5052-182	ST CEBOTOME BUR, 6MM SIDE CUTTING	67
5052-191	ST CEBOTOME BUR, 7.0MM CONTOURED	67
5052-184	ST CEBOTOME BUR, 7MM ROUND	67
5052-183	ST CEBOTOME BUR, 7MM SIDE CUTTING	67
5052-187	ST CEBOTOME BUR, 8.5MM BARREL	67
5052-192	ST CEBOTOME BUR, 8.5MM CONTOURED	67
5052-185	ST CEBOTOME BUR, 8MM ROUND	67
5052-186	ST CEBOTOME BUR, 9MM ROUND	67
5052-144	ST CEBOTOME METAL CUTTINGBUR SIDE/FLAT	27, 67
5052-145	ST CEBOTOME METAL CUTTINGBUR SIDE/ROUND	27, 67
E4110	ST E9000® BUR STEEL WIRE PASS 1.0 X 38MM	60
E4115	ST E9000 BUR STEEL WIRE PASS 1.5 X 38MM	60
E4120	ST E9000 BUR STEEL WIRE PASS 2.0 X 38MM	60
E8165	ST E9000 RND CARBIDE 6.5 38MM	59
E8030LSO	ST E9000 RND CARBIDE BUR LSO 3 X 30MM	59
E8130LSO	ST E9000 RND CARBIDE BUR LSO 3 X 38MM	59
E8230LSO	ST E9000 RND CARBIDE BUR LSO 3 X 48MM	59
E8040LSO	ST E9000 RND CARBIDE BUR LSO 4 X 30MM	59
E8140LSO	ST E9000 RND CARBIDE BUR LSO 4 X 38MM	59
E8240LSO	ST E9000 RND CARBIDE BUR LSO 4 X 48MM	59
E8050LSO	ST E9000 RND CARBIDE BUR LSO 5 X 30MM	59
E8150LSO	ST E9000 RND CARBIDE BUR LSO 5 X 38MM	59
E8250LSO	ST E9000 RND CARBIDE BUR LSO 5 X 48MM	59
E8065LSO	ST E9000 RND CARBIDE BUR LSO 6.5 X 30MM	59
E8165LSO	ST E9000 RND CARBIDE BUR LSO 6.5 X 38MM	59
E6205	ST E9000 RND DMD BUR 0.5 X 48MM	59
E6207	ST E9000 RND DMD BUR 0.7 X 48MM	59
E6210	ST E9000 RND DMD BUR 1.0 X 48MM	59
E6215	ST E9000 RND DMD BUR 1.5 X 48MM	59
E6220	ST E9000 RND DMD BUR 2 X 48	59
E6230	ST E9000 RND DMD BUR 3.0 X 48MM	59
E6240	ST E9000 RND DMD BUR 4 X 48	59
E6040	ST E9000 RND DMD BUR 4.0 X 30MM	59
E6140	ST E9000 RND DMD BUR 4.0 X 38MM	59
E6150	ST E9000 RND DMD BUR 5.0 X 38MM	59
E6250	ST E9000 RND DMD BUR 5.0 X 48MM	59
E6160	ST E9000 RND DMD BUR 6.0 X 38MM	59
E5215	ST E9000 RND DMD CRS 1.5 X 48MM	59
E5210	ST E9000 RND DMD CRS BUR 1.0 X 48MM	59
E5220	ST E9000 RND DMD CRS BUR 2.0 X 48MM	59
E5230	ST E9000 RND DMD CRS BUR 3.0 X 48MM	59
E5240	ST E9000 RND DMD CRS BUR 4.0 X 48MM	59
E5050	ST E9000 RND DMD CRS BUR 5.0 X 48MM	59
E5170	ST E9000 RND DMD CRS BUR 7.0 X 38MM	59
E5130	ST E9000 RND DMD CRS BURR 6.0 X 38MM	59
E8205	ST E9000 RND STEEL BUR 0.5 X 48MM	59
E8007	ST E9000 RND STEEL BUR 0.7 X 30MM	59

Cat. No.	Description	Page No.
E8207	ST E9000® RND STEEL BUR 0.7 X 48MM	59
E8010	ST E9000 RND STEEL BUR 1.0 X 30MM	59
E8210	ST E9000 RND STEEL BUR 1.0 X 48MM	59
E8015	ST E9000 RND STEEL BUR 1.5 X 30MM	59
E8215	ST E9000 RND STEEL BUR 1.5 X 48MM	59
E8020	ST E9000 RND STEEL BUR 2.0 X 30MM	59
E8220	ST E9000 RND STEEL BUR 2.0 X 48MM	59
E8025	ST E9000 RND STEEL BUR 2.5 X 30MM	59
E8225	ST E9000 RND STEEL BUR 2.5 X 48MM	59
5059-531	ST EXTENDED STERNUM SAW BLADES 5 EA	68
5071-110	ST GRAFT HARVESTING BLD 10 X 20	39
5071-111	ST GRAFT HARVESTING BLD 11 X 20	39
5071-112	ST GRAFT HARVESTING BLD 12 X 20	39
5071-113	ST GRAFT HARVESTING BLD 13 X 25	39
5071-105	ST GRAFT HARVESTING BLD 5 X 20	39
5071-106	ST GRAFT HARVESTING BLD 6 X 20	39
5071-107	ST GRAFT HARVESTING BLD 7 X 20	39
5071-108	ST GRAFT HARVESTING BLD 8 X 20	39
5071-109	ST GRAFT HARVESTING BLD 9 X 20	39
5053-122	ST MICRO RECIP BLADE 25.5 X 25MM	50
5053-126	ST MICRO RECIP BLADE 28.0 X 0.6MM	50
5053-220	ST MICRO RECIPROCTING SAW BLADES, 25.5MM	50
5053-221	ST MICRO RECIPROCTING SAW BLADES, 38MM 5/BOX	50
5071-175	ST OSC ABRASION BLADE	43
5071-145	ST OSC BLD 13 X 72 X 1.2MM 5 EA	40, 43
5071-132	ST OSC BLD 19.5 X 41 X .4MM 5 EA	40
5071-174	ST OSC BLD 19.5 X 86 X .8MM 5 EA	40, 42
5071-163	ST OSC BLD 25.4 X 90 X 1.37MM 5 EA	29, 35
5071-135	ST OSC BLD 5 X 30 X .6MM 5 EA	39
5071-134	ST OSC BLD 9 X 41 X .4MM 5 EA	39
5071-133	ST OSC BLD 9.5 X 25 X .4MM 5 EA	39
5071-141	ST OSC BLD COATED, 19.5 X 80 X 1.2MM 5 EA	40, 43
5071-167	ST OSC BLD COATED, 19.5 X 90 X 1.2MM 5 EA	29, 32
5071-140	ST OSC BLD COATED, 25.4 X 80 X 1.2MM 5 EA	40, 43
5071-143	ST OSC BLD COATED, 25.4 X 90 X .8MM 5 EA	40, 42
5071-142	ST OSC BLD COATED, 25.4 X 90 X 1.2MM 5 EA	40, 43
5071-144	ST OSC BLD COATED, 25.4 X 90 X 1.5MM 5 EA	29, 35
5023-171	ST OSC BLDE CRES 13.5 X 25.5 X 0.4	49
5023-176	ST OSC BLDE CRES 13.5 X 32 X 0.4	49
5023-172	ST OSC BLDE CRES 18 X 32 X 0.4	49
5023-170	ST OSC BLDE CRES 9 X 12 X 0.4	49
5023-161	ST OSC BLDE FINE 10 X 12 X 0.4MM 5 EA	49
5023-163	ST OSC BLDE FINE 10 X 18.5 X 0.4MM 5 EA	49
5023-169	ST OSC BLDE FINE 10 X 35 X 0.4MM 5 EA	49
5023-166	ST OSC BLDE FINE 18.5 X 28.5 X 0.4MM 5 EA	49
5023-168	ST OSC BLDE FINE 20 10 X 13 X 0.4MM 5 EA	49
5023-167	ST OSC BLDE FINE 20 5.5 X 13 X 0.4MM 5 EA	49
5023-160	ST OSC BLDE FINE 5.5 X 12 X 0.4MM 5 EA	49
5023-162	ST OSC BLDE FINE 5.5 X 18.5 X 0.4MM 5 EA	49
5023-164	ST OSC BLDE FINE 5.5 X 28.5 X 0.4MM 5 EA	49
5023-259	ST OSC BLDE RADSD 10 X 13.5 X 0.4MM 5 EA	49
5023-165	ST OSC BLDE RADSD 10 X 28.5 X 0.4MM 5 EA	49
5023-258	ST OSC BLDE RADSD 10 X 9 X 0.4MM 5 EA	49
5071-552	ST OSCIL BLADE 13.5 X 64 X .6MM 5 EA	40, 41
5071-553	ST OSCIL BLADE 19.5 X 63 X .6MM 5 EA	40
5071-146	ST OSCIL BLADE 25 X 90 X .9MM 5 EA	29, 31
5071-551	ST OSCIL BLADE 32.5 X 63 X .6MM 5 EA	40
5071-556	ST OSCIL BLADE 33.5 X 64 X .8MM 5 EA	40, 41
5071-550	ST OSCIL BLADE 49 X 63 X .6 MM 5 EA	40, 41

Alphabetical Index



Cat. No.	Description	Page No.
1384-175	ST OSCIL BLADE 50 X 19 X .4MM	68
5071-125	ST OSCIL BLADE 50 X 19 X 0.4MM	68, 69
1384-176	ST OSCIL BLADE 63 X 1 9 X .4MM	68
5071-126	ST OSCIL BLADE 63 X 19 X 0.4MM	68, 69
5071-127	ST OSCIL BLADE 8.5 X 38 X 0.4MM	39
5071-177	ST OSCIL BLADE, COATED, 19.5MM 5 EA	40, 41
5071-178	ST OSCIL BLADE, COATED, 19.5MM 5 EA	40, 42
5071-195	ST OSCIL BLADE, COATED, 19.5MM 5 EA	29, 31
5071-572	ST OSCIL BLD 71 X 19.5 X 0.8MM 5 EA	40, 42
5071-554	ST OSCIL BLD 71 X19.5 X 1.2MM 5 EA	40, 43
5071-555	ST OSCIL BLD 71 X33 X1.2MM 5 EA	40, 43
5071-166	ST OSCIL BLD, COATED, 32 X 64MM 5 EA	40, 41
5056-176	ST OST DP ACCESS BUR RND DIAMOND 4.0	66
5056-958	ST OST RND DMD CRS BUR 1.0 X 48	66
5056-963	ST OST RND DMD CRS BUR 1.5 X 48	66
5056-962	ST OST RND DMD CRS BUR 2.0 X 48	66
5056-959	ST OST RND DMD CRS BUR 3.0 X 48	66
5056-952	ST OST RND DMD CRS BUR 4.0 X 48	66
5056-950	ST OST RND DMD CRS BUR 5.0 X 48	66
5056-967	ST OST RND DMD CRS BUR 6.0 X 38	66
5056-149	ST OSTEON BUR CARBIDE ROUND, 2.5 X 48.0MM	66
5056-128	ST OSTEON BUR CARBIDE ROUND, 3.0 X 38M	66
5056-146	ST OSTEON BUR CARBIDE ROUND, 3.0 X 48M	26, 66
5056-145	ST OSTEON BUR CARBIDE ROUND, 4.0 X 48M	26, 66
5056-144	ST OSTEON BUR CARBIDE ROUND, 5.0 X 48M	66
5056-160	ST OSTEON BUR DIAMOND ROUND, 0.7 X 48M	66
5056-158	ST OSTEON BUR DIAMOND ROUND, 1.0 X 48M	26, 66
5056-163	ST OSTEON BUR DIAMOND ROUND, 1.5 X 48M	66
5056-162	ST OSTEON BUR DIAMOND ROUND, 2.0 X 48M	26, 66
5056-159	ST OSTEON BUR DIAMOND ROUND, 3.0 X 48M	26, 66
5056-168	ST OSTEON BUR DIAMOND ROUND, 4.0 X 30M	66
5056-148	ST OSTEON BUR DIAMOND ROUND, 4.0 X 38M	66
5056-152	ST OSTEON BUR DIAMOND ROUND, 4.0 X 48M	26, 66
5056-147	ST OSTEON BUR DIAMOND ROUND, 5.0 X 38M	66
5056-150	ST OSTEON BUR DIAMOND ROUND, 5.0 X 48M	66
5056-167	ST OSTEON BUR DIAMOND ROUND, 6.0 X 38M	66
5056-109	ST OSTEON BUR SET	19
5056-166	ST OSTEON BUR STEEL ROUND, 0.5 X 48M	26, 66
5056-173	ST OSTEON BUR STEEL ROUND, 0.7 X 30M	66
5056-165	ST OSTEON BUR STEEL ROUND, 0.7 X 48M	66
5056-174	ST OSTEON BUR STEEL ROUND, 1.0 X 30M	66
5056-164	ST OSTEON BUR STEEL ROUND, 1.0 X 48M	26, 66
5056-177	ST OSTEON BUR STEEL ROUND, 1.5 X 30M	66
5056-142	ST OSTEON BUR STEEL ROUND, 2.0 X 48M	26, 66
5056-179	ST OSTEON BUR STEEL ROUND, 2.5 X 30M	66
5056-184	ST OSTEON BUR STEEL WIRE PASS, 1.0	66
5056-185	ST OSTEON BUR STEEL WIRE PASS, 1.5	66
5056-186	ST OSTEON BUR STEEL WIRE PASS, 2.0	66
5056-140	ST OSTEON BUR STEEL, ROUND, 1.5 X 48M	26, 66
5056-119	ST OSTEON BUR, CARBIDE ROUND, 4.0 X 30M	26, 66
5056-127	ST OSTEON BUR, CARBIDE ROUND, 4.0 X 38M	66
5056-118	ST OSTEON BUR, CARBIDE ROUND, 5.0 X 30M	26, 66
5056-126	ST OSTEON BUR, CARBIDE ROUND, 5.0 X 38M	26, 66
5056-117	ST OSTEON BUR, CARBIDE ROUND, 6.5 X 30M	26, 66
5056-125	ST OSTEON BUR, CARBIDE ROUND, 6.5 X 38M	66
5056-116	ST OSTEON BUR,CARBIDE ROUND, 3.0 X 30M	66
5056-175	ST OSTEON DEEP ACCESS BURRND DIAMOND 3.0	66
5056-172	ST OSTEON DP ACCESS BUR OVAL, 5.5 X 95.0	66
5056-170	ST OSTEON DP ACCESS BUR ROUND, 3.0 X 90.	66

Cat. No.	Description	Page No.
5056-171	ST OSTEON DP ACCESS BUR ROUND, 4.0 X 90.	66
5056-161	ST OSTEON BUR DIAMOND ROUND, 0.5 X 48M	26, 66
5093-238	ST OVAL CARBIDE BURS, 5.5 X 10, X-LONG 5 EA	52
5092-236	ST OVAL CARBIDE BURS, LONG, 4 X 8MM 5 EA	51, 52
5092-238	ST OVAL CARBIDE BURS, LONG, 5.5 X 10MM 5 EA	52
5091-238	ST OVAL CARBIDE BURS, MED, 5.5 X 10MM 5 EA	52
5091-236	ST OVAL CARBIDE BURS, MEDIUM 4 X 8MM 5 EA	52
5093-236	ST OVAL CARBIDE BURS, X-LONG, 4 X 8MM 5 EA	52
5092-270	ST OVAL DIAMOND BURS, LONG, 4 X 8MM 5 EA	51
5091-270	ST OVAL DIAMOND BURS, MED, 4 X 8MM 5 EA	51
5052-173	ST RECIPROCATOR BLADE 12.5 X 73.5MM 5 EA	44
5023-179	ST REPEAT STERN BLADE 54.6MM 5 EA	68
5023-188	ST REPEAT STERN BLADE 63 X 24 X .4MM	68
5023-187	ST REPEAT STERN BLD 50 X 24 X .4MM	68
5059-278	ST REPEAT STERNOTOMY BLADE 44.5MM 5 EA	68, 69
5059-279	ST REPEAT STERNOTOMY BLADE 54.6MM 5 EA	68, 69
5059-280	ST REPEAT STERNOTOMY BLADE 65.8MM 5 EA	68, 69
5059-233	ST REPL BLADE/SARNS STERNUM SAW 5 EA	68
5052-334	ST REPL BLADE/STRYKER RECIP 12.5MM 5 EA	45
5052-332	ST REPL BLADE/STRYKER RECIP 76.0MM 5 EA	45
5052-333	ST REPL BLADE/STRYKER RECIP 76.0MM 5 EA	45
5059-235	ST REPL BLADE/STRYKER STERNUM SAW 5 EA	68
5072-101	ST REPL BLD/STRYKER COATED, 19.5 X 1.27 X 86MM	36, 38
5072-181	ST REPL BLD/STRYKER 19.5 X 1.27 X 86MM	36, 38
5072-143	ST REPL BLD/STRYKER 25.4 X .8 X 90MM	36
5072-142	ST REPL BLD/STRYKER 25.4 X 1.2 X 90MM	36, 37
5072-152	ST REPL STRYKER SAG 12.45 X 1.19 X 82.18MM	36, 37
5072-158	ST REPL STRYKER SAG 12.45 X 82.12 X 1.27MM	36, 38
5072-150	ST REPL STRYKER SAG 12.5 X 73.79 X .64MM	36
5072-109	ST REPL STRYKER SAG 20.7 X 85.04 X .89MM	36, 37
5072-105	ST REPL STRYKER SAG 24.82 X 73.79 X .89MM	36, 37
5072-110	ST REPL STRYKER SAG 24.82 X 73.79 X 1.27MM	36, 38
5072-111	ST REPL STRYKER SAG 24.82 X 80.14 X 1.27MM	36, 38
5072-176	ST REPL STRYKER SAG 24.82 X 80.14 X 1.50MM	36, 38
5072-177	ST REPL STRYKER SAG 24.82 X 82.42 X 1.37MM	36, 38
5072-151	ST REPL STRYKER SAG 24.82 X 85.67 X 1.19MM	36, 37
5072-102	ST REPL STRYKER SAG 24.82 X 90.47 X .89MM	36, 37
5072-100	ST REPL STRYKER SAG 24.94 X 73.79 X .64MM	36
5072-183	ST REPL STRYKER SAG 28.91 X 1.27 X 84.47MM	36, 38
5072-140	ST REPL STRYKER SAG 29.46 X 58.7 X .64MM	36
5072-145	ST REPL STRYKER SAG 9.12 X 25.22 X .64MM	36
5092-274	ST RHINOPLASTY DIAMOND BURS, LONG, 5 EA	51
5093-221	ST RND BUR CARBIDE .5MM 5 EA	51
5093-226	ST RND BUR CARBIDE 3.0MM 5 EA	51
5093-232	ST RND BUR CARBIDE 6.5MM 5 EA	51
5092-291	ST RND CYL BUR LNG 3MM/AM8 5 EA	53
5093-264	ST RND DIAMOND BUR XL 4.0MM 5 EA	51
5092-292	ST RND/CYL BUR LG 4.0MM 5 PK	53
5093-220	ST ROUND BUR, CARBIDE 1.0MM 5 EA	51
5091-221	ST ROUND CARBIDE BUR, MEDIUM, 1.8MM 5 EA	51
5091-223	ST ROUND CARBIDE BUR, MEDIUM, 2.3MM 5 EA	51
5091-224	ST ROUND CARBIDE BUR, MEDIUM, 2MM 5 EA	51
5092-232	ST ROUND CARBIDE BURS LONG, 6.5MM 5 EA	51
5092-222	ST ROUND CARBIDE BURS, LONG, 1.5MM 5 EA	51
5092-220	ST ROUND CARBIDE BURS, LONG, 1MM 5 EA	51
5092-224	ST ROUND CARBIDE BURS, LONG, 2MM 5 EA	51
5092-226	ST ROUND CARBIDE BURS, LONG, 3MM 5 EA	51
5092-228	ST ROUND CARBIDE BURS, LONG, 4MM 5 EA	51
5092-230	ST ROUND CARBIDE BURS, LONG, 5MM 5 EA	51

Alphabetical Index



Cat. No.	Description	Page No.
5091-222	ST ROUND CARBIDE BURS, MEDIUM, 1.5MM 5 EA	51
5091-225	ST ROUND CARBIDE BURS, MEDIUM, 2.4MM 5 EA	51
5091-226	ST ROUND CARBIDE BURS, MEDIUM, 3MM 5 EA	51
5091-228	ST ROUND CARBIDE BURS, MEDIUM, 4MM 5 EA	51
5091-230	ST ROUND CARBIDE BURS, MEDIUM, 5MM 5 EA	51
5091-232	ST ROUND CARBIDE BURS, MEDIUM, 6.5MM 5 EA	51
5093-224	ST ROUND CARBIDE BURS, X-LONG, 2MM 5 EA	51
5093-228	ST ROUND CARBIDE BURS, X-LONG, 4MM 5 EA	51
5093-230	ST ROUND CARBIDE BURS, X-LONG, 5MM 5 EA	51
5093-291	ST ROUND CYLNDRL BUR,M-8 TYPE, LONG 5 EA	53
5092-260	ST ROUND DIAMOND BUR, LONG 2.0MM 5 EA	51
5092-262	ST ROUND DIAMOND BURS, LONG, 3MM 5 EA	51
5092-264	ST ROUND DIAMOND BURS, LONG, 4MM 5 EA	51
5092-266	ST ROUND DIAMOND BURS, LONG, 5MM 5 EA	51
5092-268	ST ROUND DIAMOND BURS, LONG, 6MM 5 EA	51
5091-260	ST ROUND DIAMOND BURS, MED, 2MM 5 EA	51
5091-264	ST ROUND DIAMOND BURS, MED, 4MM 5 EA	51
5091-268	ST ROUND DIAMOND BURS, MED, 6MM 5 EA	51
5093-260	ST ROUND DIAMOND BURS, X-LONG, 2MM 5 EA	51
5093-262	ST ROUND DIAMOND BURS, X-LONG, 3MM 5 EA	51
5093-266	ST ROUND DIAMOND BURS, X-LONG, 5MM 5 EA	51
5023-144	ST SAG BLADE 5.5 X 18.5 X .4MM 5 EA	46
5023-129	ST SAG BLDE FN 70D 9.5 X 13.5 X 0.6MM 5 EA	47
5023-137	ST SAG BLDE CRS 14 X 25.5 X 0.4MM 5 EA	46
5023-133	ST SAG BLDE CRS 14.0 X 41.0 X 0.4MM 5 EA	46
5023-130	ST SAG BLDE CRS 19.5 X 25.5 X 0.4MM 5 EA	46
5023-131	ST SAG BLDE CRS 19.5 X 41.0 X 0.4MM 5 EA	46
5023-135	ST SAG BLDE CRS 45 5.5 X 18 X 0.6MM 5 EA	47
5023-132	ST SAG BLDE CRS 5.5 X 25.5 X 0.4MM 5 EA	46
5023-143	ST SAG BLDE CRS 9.5 X 25.5 X 0.4MM 5 EA	46
5023-142	ST SAG BLDE FINE 4 X 34 X 0.4MM 5 EA	46
5023-139	ST SAG BLDE FINE 4.5 X 25.5 X 0.4MM 5 EA	46
5023-141	ST SAG BLDE FINE 6 X 34 X 0.4MM 5 EA	46
5023-118	ST SAG BLDE FINE 9.5 X 25.5 X 0.4MM 5 EA	46
5023-138	ST SAG BLDE FINE 9.5 X 25.5 X 0.4MM 5 EA	46
5023-140	ST SAG BLDE FINE 9.5 X 41 X 0.4MM 5 EA	46
5023-128	ST SAG BLDE FN 70D 9.5 X 7.5 X 0.6MM 5 EA	47
5092-206	ST SIDE CUT CBD BUR LG,TAPER 2 X 7.5MM 5 EA	52
5091-219	ST SIDE CUT CARB BUR MED, ROUND 1.2M 5 EA	52
5091-218	ST SIDE CUT CARBD BUR MED TAP 1.6M 5 EA	52
E4208	ST SIDE CUT CARBIDE .8 X 4.9	60
E4220	ST SIDE CUT CARBIDE 2 X 7.5	60
5091-216	ST SIDE CUT CARBIDE BUR MED, STR, 5 EA	52
5091-217	ST SIDE CUT CARBIDE BUR MED, STR, 5 EA	52
5091-214	ST SIDE CUT CARBIDE BUR MED, TAPER, 5 EA	52
5091-215	ST SIDE CUT CARBIDE BUR MED, TAPER, 5 EA	52
5091-202	ST SIDE CUT CARBIDE BURS, MED, STR 5 EA	52
5091-206	ST SIDE CUT CARBIDE BURS, MED, TAPER 5 EA	52
5092-203	ST SIDE CUT CBD BUR, LONG, TAPER 1.7MM 5 EA	52
5092-214	ST SIDE CUT CBD BURS, LONG, TAPER 5 EA	52
5091-212	ST SIDE CUT CBD BURS, MED, LIND 1.6MM 5 EA	53
5092-212	ST SIDE CUT CBD BURS, MED, LIND 1.6MM 5 EA	53
5089-208	ST SIDE CUT CRBD BUR 1.5 X 8.0MM 5 EA	52
5091-201	ST SIDE CUT CRBDE BUR, MED, STR, 1 X 5MM 5 EA	52
5059-532	ST STERNUM SAW BLADES 10 X 35 X 0.66MM 5 EA	68
5091-245	ST SWANSON REAMER STEEL BUR, MED 5MM 5 EA	51
5091-242	ST SWANSON REAMER STEEL BUR, MED, 5 EA	51
5091-243	ST SWANSON REAMER STEEL BURS, MED, 5 EA	51
5091-244	ST SWANSON REAMER STEEL BURS, MED, 5 EA	51

Cat. No.	Description	Page No.
7021-094	ST ULTPWR BUR RND END 3.2/MDS WH2	65
7021-119	ST ULTRAPOWER® BUR 1.5MM CROSSCUT	63
7021-383	ST ULTRAPOWER BUR ACORN 9.0/MDS AM-1	64
7021-181	ST ULTRAPOWER BUR ACORN 6.0/MDS 0.3	64
7021-381	ST ULTRAPOWER BUR ACORN 6.0/MDS AM-3	64
7021-281	ST ULTRAPOWER BUR ACORN 6.0/MDS M-3	64
7021-581	ST ULTRAPOWER BUR ACORN 6.0/MDS R-3	64
7021-681	ST ULTRAPOWER BUR ACORN 6.0/MDS RX-3	64
7021-081	ST ULTRAPOWER BUR ACORN 6.0MM	64
7021-183	ST ULTRAPOWER BUR ACORN 9.0/MDS 0-1	64
7021-583	ST ULTRAPOWER BUR ACORN 9.0/MDS R-1	64
7021-683	ST ULTRAPOWER BUR ACORN 9.0/MDS RX-1	64
7021-483	ST ULTRAPOWER BUR ACORN 9.0/MDS TU-1	64
7021-083	ST ULTRAPOWER BUR ACORN 9.0MM	64
7021-256	ST ULTRAPOWER BUR CUTTER 10.7MM	65
7021-257	ST ULTRAPOWER BUR CUTTER 13.5MM	65
7021-258	ST ULTRAPOWER BUR CUTTER 16.8MM	65
7021-161	ST ULTRAPOWER BUR DMD 1.0MM	61
7021-062	ST ULTRAPOWER BUR DMD 2.0MM	61
7021-162	ST ULTRAPOWER BUR DMD 2.0MM	61
7021-362	ST ULTRAPOWER BUR DMD 2.0MM	61
7021-063	ST ULTRAPOWER BUR DMD 3.0MM	61
7021-163	ST ULTRAPOWER BUR DMD 3.0MM	61
7021-263	ST ULTRAPOWER BUR DMD 3.0MM	61
7021-363	ST ULTRAPOWER BUR DMD 3.0MM	61
7021-064	ST ULTRAPOWER BUR DMD 4.0MM	61
7021-164	ST ULTRAPOWER BUR DMD 4.0MM	61
7021-264	ST ULTRAPOWER BUR DMD 4.0MM	61
7021-364	ST ULTRAPOWER BUR DMD 4.0MM	61
7021-065	ST ULTRAPOWER BUR DMD 5.0MM	61
7021-165	ST ULTRAPOWER BUR DMD 5.0MM	61
7021-265	ST ULTRAPOWER BUR DMD 5.0MM	61
7021-365	ST ULTRAPOWER BUR DMD 5.0MM	61
7021-066	ST ULTRAPOWER BUR DMD 6.0MM	61
7021-166	ST ULTRAPOWER BUR DMD 6.0MM	61
7021-266	ST ULTRAPOWER BUR DMD 6.0MM	61
7021-172	ST ULTRAPOWER BUR DMD CRS 2.0MM	62
7021-173	ST ULTRAPOWER BUR DMD CRS 3.0MM	62
7021-174	ST ULTRAPOWER BUR DMD CRS 4.0MM	62
7021-175	ST ULTRAPOWER BUR DMD CRS 5.0MM	62
7021-176	ST ULTRAPOWER BUR DMD CRS 6.0MM	62
7021-492	ST ULTRAPOWER BUR DMD WHEEL/MDS TU-51	65
7021-262	ST ULTRAPOWER BUR DND 2.0MM	61
7021-195	ST ULTRAPOWER BUR OVAL 4.0 X 8.0MM	65
7021-295	ST ULTRAPOWER BUR OVAL 4.0 X 8MM	65
7021-095	ST ULTRAPOWER BUR OVAL 4.0MM	65
7021-395	ST ULTRAPOWER BUR OVAL 4.0MM	65
7021-196	ST ULTRAPOWER BUR OVAL 5.5 X 10MM	65
7021-296	ST ULTRAPOWER BUR OVAL 5.5 X 10MM	65
7021-096	ST ULTRAPOWER BUR OVAL 5.5MM	65
7021-396	ST ULTRAPOWER BUR OVAL 5.5MM	65
7021-220	ST ULTRAPOWER BUR RND 0.5MM	61
7021-122	ST ULTRAPOWER BUR RND 1.0MM	61
7021-222	ST ULTRAPOWER BUR RND 1.0MM	61
7021-322	ST ULTRAPOWER BUR RND 1.0MM	61
7021-123	ST ULTRAPOWER BUR RND 1.5MM	61
7021-223	ST ULTRAPOWER BUR RND 1.5MM	61
7021-323	ST ULTRAPOWER BUR RND 1.5MM	61
7021-233	ST ULTRAPOWER® BUR RND 10.0	61

Alphabetical Index



Cat. No.	Description	Page No.
7021-033	ST ULTRAPOWER BUR RND 10.0MM	61
7021-133	ST ULTRAPOWER BUR RND 10.0MM	61
7021-333	ST ULTRAPOWER BUR RND 10.0MM	61
7021-433	ST ULTRAPOWER BUR RND 10.0MM	61
7021-533	ST ULTRAPOWER BUR RND 10.0MM	61
7021-633	ST ULTRAPOWER BUR RND 10.0MM	61
7021-024	ST ULTRAPOWER BUR RND 2.0MM	61
7021-124	ST ULTRAPOWER BUR RND 2.0MM	61
7021-224	ST ULTRAPOWER BUR RND 2.0MM	61
7021-324	ST ULTRAPOWER BUR RND 2.0MM	61
7021-025	ST ULTRAPOWER BUR RND 2.5MM	61
7021-125	ST ULTRAPOWER BUR RND 2.5MM	61
7021-225	ST ULTRAPOWER BUR RND 2.5MM	61
7021-325	ST ULTRAPOWER BUR RND 2.5MM	61
7021-226	ST ULTRAPOWER BUR RND 3.00MM	61
7021-026	ST ULTRAPOWER BUR RND 3.0MM	61
7021-126	ST ULTRAPOWER BUR RND 3.0MM	61
7021-326	ST ULTRAPOWER BUR RND 3.0MM	61
7021-426	ST ULTRAPOWER BUR RND 3.0MM	61, 62
7021-526	ST ULTRAPOWER BUR RND 3.0MM	61, 62
7021-027	ST ULTRAPOWER BUR RND 4.0MM	61
7021-127	ST ULTRAPOWER BUR RND 4.0MM	61
7021-227	ST ULTRAPOWER BUR RND 4.0MM	61
7021-327	ST ULTRAPOWER BUR RND 4.0MM	61
7021-427	ST ULTRAPOWER BUR RND 4.0MM	61, 62
7021-328	ST ULTRAPOWER BUR RND 5.0/MDS AM-35	61
7021-228	ST ULTRAPOWER BUR RND 5.0/MOS M-35	61
7021-028	ST ULTRAPOWER BUR RND 5.0MM	61
7021-128	ST ULTRAPOWER BUR RND 5.0MM	61
7021-428	ST ULTRAPOWER BUR RND 5.0MM	61
7021-528	ST ULTRAPOWER BUR RND 5.0MM	61
7021-329	ST ULTRAPOWER BUR RND 6.0/MDS AM-33	61
7021-529	ST ULTRAPOWER BUR RND 6.0/MDS R-33	61
7021-429	ST ULTRAPOWER BUR RND 6.0/MDS TU-33	61
7021-029	ST ULTRAPOWER BUR RND 6.0MM	61
7021-129	ST ULTRAPOWER BUR RND 6.0MM	61
7021-030	ST ULTRAPOWER BUR RND 6.5MM	61
7021-130	ST ULTRAPOWER BUR RND 6.5MM	61
7021-230	ST ULTRAPOWER BUR RND 6.5MM	61
7021-231	ST ULTRAPOWER BUR RND 7.5/MDS M-32	61
7021-531	ST ULTRAPOWER BUR RND 7.5/MDS R-32	61
7021-631	ST ULTRAPOWER BUR RND 7.5/MDS RX-32	61
7021-431	ST ULTRAPOWER BUR RND 7.5/MDS TU-32	61
7021-031	ST ULTRAPOWER BUR RND 7.5MM	61
7021-131	ST ULTRAPOWER BUR RND 7.5MM	61
7021-034	ST ULTRAPOWER BUR RND 8.0MM	61
7021-134	ST ULTRAPOWER BUR RND 8.0MM	61
7021-232	ST ULTRAPOWER BUR RND 9.0/MDS M-31	61
7021-532	ST ULTRAPOWER BUR RND 9.0/MDS R-31	61
7021-632	ST ULTRAPOWER BUR RND 9.0/MDS RX-31	61
7021-432	ST ULTRAPOWER BUR RND 9.0/MDS TU-31	61
7021-032	ST ULTRAPOWER BUR RND 9.0MM	61
7021-132	ST ULTRAPOWER BUR RND 9.0MM	61
7021-337	ST ULTRAPOWER BUR RND CYL 3.0/MDS AM-	63
7021-237	ST ULTRAPOWER BUR RND CYL 3.0/MDS M-8	63
7021-261	ST ULTRAPOWER BUR RND DMD 1.0MM	61
7021-361	ST ULTRAPOWER BUR RND DMD 1.0MM	61
7021-474	ST ULTRAPOWER BUR RND DMD 4MM	62
7021-366	ST ULTRAPOWER® BUR RND DMD 6.0MM	61

Cat. No.	Description	Page No.
7021-167	ST ULTRAPOWER BUR RND DMD 7.0MM	61
7021-267	ST ULTRAPOWER BUR RND DMD 7.0MM	61
7021-367	ST ULTRAPOWER BUR RND DMD 7.0MM	61
7021-271	ST ULTRAPOWER BUR RND DMD CRS 1.0MM	62
7021-371	ST ULTRAPOWER BUR RND DMD CRS 1.0MM	62
7021-272	ST ULTRAPOWER BUR RND DMD CRS 2.0MM	62
7021-372	ST ULTRAPOWER BUR RND DMD CRS 2.0MM	62
7021-273	ST ULTRAPOWER BUR RND DMD CRS 3.0MM	62
7021-373	ST ULTRAPOWER BUR RND DMD CRS 3.0MM	62
7021-074	ST ULTRAPOWER BUR RND DMD CRS 4.0MM	62
7021-274	ST ULTRAPOWER BUR RND DMD CRS 4.0MM	62
7021-374	ST ULTRAPOWER BUR RND DMD CRS 4.0MM	62
7021-075	ST ULTRAPOWER BUR RND DMD CRS 5.0MM	62
7021-275	ST ULTRAPOWER BUR RND DMD CRS 5.0MM	62
7021-375	ST ULTRAPOWER BUR RND DMD CRS 5.0MM	62
7021-276	ST ULTRAPOWER BUR RND DMD CRS 6.0MM	62
7021-376	ST ULTRAPOWER BUR RND DMD CRS 6.0MM	62
7021-277	ST ULTRAPOWER BUR RND DMD CRS 7.0MM	62
7021-067	ST ULTRAPOWER BUR RND DMD7.0MM	61
7021-171	ST ULTRAPOWER BUR RND DMD CRS 1.0MM	62
7021-077	ST ULTRAPOWER BUR RND DMD CRS 7.0MM	62
7021-294	ST ULTRAPOWER BUR RND END 3.2/MDS M-5	65
7021-136	ST ULTRAPOWER BUR RND/CYL 2.2MM	63
7021-037	ST ULTRAPOWER BUR RND/CYL 3.0MM	63
7021-036	ST ULTRAPOWER BUR RND/CYL2.2MM	63
7021-510	ST ULTRAPOWER BUR STRT 10.5 X 11 R14	62
7021-610	ST ULTRAPOWER BUR STRT 10.5 X 11 RX-1	62
7021-210	ST ULTRAPOWER BUR STRT 10.5 X 11MDS M14	62
7021-043	ST ULTRAPOWER BUR STRT HD 1.2 X 6MM	63
7021-713	ST ULTRAPOWER BUR TPRD 1.8 X 11	60, 63
7021-815	ST ULTRAPOWER BUR TPRD 2.2 X 16	60, 63
7021-917	ST ULTRAPOWER BUR TPRD 3 X 25/MDS S1	60, 63
7021-318	ST ULTRAPOWER BUR TPRD 3 X 36/MDS AM-10	63
7021-015	ST ULTRAPOWER BUR TRPD 2.2MM X 16MM	63
7021-040	ST ULTRAPOWER BUR WIREPASS 1.0MM	65
7021-140	ST ULTRAPOWER BUR WIREPASS 1.0MM	65
7021-041	ST ULTRAPOWER BUR WIREPASS 1.5MM	65
7021-141	ST ULTRAPOWER BUR WIREPASS 1.5MM	65
7021-042	ST ULTRAPOWER BUR WIREPASS 2.0MM	65
7021-142	ST ULTRAPOWER BUR WIREPASS 2.0MM	65
7021-392	ST ULTRAPOWER DMD WHEEL /MDS AM-51	65
7021-092	ST ULTRAPOWER DMD WHEEL 25.4	65
7021-292	ST ULTRAPOWER DMD WHEEL/MDS M-51	65
7021-014	ST ULTRAPOWER TRPD	65
7021-013	ST ULTRAPOWER TRPD 1.8MM X 11MM	63, 65
7021-177	ST UP BUR RND CRS DIAMOND 7.0MM	62
7021-377	ST UP BUR RND CRS DIAMOND 7.0MM	62
7021-310	ST UP BUR STRT 10.5 X 11MM	62
7021-143	ST UP BUR STRT HD 1.2 X 6MM	63
7021-243	ST UP BUR STRT HD 1.2 X 6MM	63
7021-113	ST UP BUR TPRD 1.8 X 11MM	63
7021-114	ST UP BUR TPRD 2 X 16MM	63
7021-115	ST UP BUR TPRD 2.2 X 16MM	63
7021-116	ST UP BUR TPRD 2.2X23MM	63
7021-252	ST UP BUR TREPHINE 10.7MM	64
7021-253	ST UP BUR TREPHINE 13.5MM	64
7021-255	ST UP BUR TREPHINE 16.8MM	64
7021-250	ST UP BUR TREPHINE 3.4MM	64
7021-051	ST UP BUR TREPHINE 5.3MM	64

Alphabetical Index



Cat. No.	Description	Page No.
7021-380	ST UPWR BUR ACORN 5.0/MDS AM25	64
7021-280	ST UPWR BUR ACORN 5.0/MDS M25	64
7021-482	ST UPWR BUR ACORN 7.5/MDS TU2	64
7021-382	ST UPWR BUR ACORN 7.5MDS AM2	64
7021-182	ST UPWR BUR ACORN 7.5MM MDS 0-2	64
7021-282	ST UPWR BUR ACORN 7.5MM/MDS M2	64
7021-297	ST UPWR BUR BARREL 10MM/MDS M23	65
7021-279	ST UPWR BUR DMD R/C3.0 MDS M8D	64
7021-379	ST UPWR BUR DMD RC 3.0MDS AM8D	64
7021-391	ST UPWR BUR FRSTRM 6.5MDS AM24	65
7021-235	ST UPWR BUR RND CYL 1.8MM	63
7021-335	ST UPWR BUR RND CYL 1.8MM	63
7021-338	ST UPWR BUR RND CYL 1.8MM	63
7021-378	ST UPWR BUR RND CYL 1.9MM	64
7021-336	ST UPWR BUR RND CYL 2.2MM	63
7021-137	ST UPWR BUR RND CYL 3.0MDS 0-8	63
7021-437	ST UPWR BUR RND CYL 3.0MDS TUB	63
7021-236	ST UPWR BUR ROUND CYL 2.2MM	63
7021-301	ST UPWR BUR STRT 3 X 20/MDS AM13	63
7021-201	ST UPWR BUR STRT 3 X 20/MDS M-13	62
7021-303	ST UPWR BUR STRT 5 X 17/MDS AM9	62
7021-302	ST UPWR BUR STRT 5 X 8/MDS AM12	62
7021-202	ST UPWR BUR STRT 5 X 8/MDS M-12	62
7021-102	ST UPWR BUR STRT 5X8/MDS-0-12	62
7021-304	ST UPWR BUR STRT 6 X 8/MDS AM11	62
7021-305	ST UPWR BUR STRT 7.5 X 5/MDS AM7	62
7021-206	ST UPWR BUR STRT 7.5 X 9 MDS M-5	62
7021-207	ST UPWR BUR STRT 7.5X28MDS M15	62
7021-106	ST UPWR BUR STRT 7.5X9/MDS 0-5	62
7021-408	ST UPWR BUR STRT 9 X 5MM/MDS-TU6	62
7021-309	ST UPWR BUR STRT 9 X 9MM/MDS AM4	62
7021-209	ST UPWR BUR STRT 9 X 9MM/MDS M-4	62
7021-509	ST UPWR BUR STRT 9 X 9MM/MDS-R4	62
7021-409	ST UPWR BUR STRT 9 X 9MM/MDS-TU4	62
7021-109	ST UPWR BUR STRT 9X9MM/MDS-0-4	62
7021-212	ST UPWR BUR TAPERED 1.5MM	63
7021-112	ST UPWR BUR TPRD 1.5 X 8MM	63
7021-012	ST UPWR BUR TPRD 1.5MM X 8MM	63, 65
7021-214	ST UPWR BUR TPRD 2.0 X 16MM	63
7021-314	ST UPWR BUR TPRD 2.0 X 16MM	63
7021-315	ST UPWR BUR TPRD 2.2 X 16MM	63
7021-218	ST UPWR BUR TPRD 3 X 36/MDS M-10	63
7021-141-35	ST UPWR DPTH LMT DRILL 1.1 X 3.5MM	65
7021-141-50	ST UPWR DPTH LMT DRILL 1.1 X 5.0MM	65
7021-141-90	ST UPWR DPTH LMT DRILL 1.1 X 9.0MM	65
7021-145-70	ST UPWR DPTH LMT DRILL 1.5 X 7.0MM	65
5090-247	ST WIRE PASS STEEL BUR, SHORT, 1 X 19MM 5 EA	51
5090-249	ST WIRE PASS STEEL BUR, SHORT, 2 X 19MM 5 EA	51
5090-248	ST WIRE PASS STEEL BUR, SHRT, 1.5 X 19MM 5 EA	51
5091-247	ST WIRE PASS STEEL BUR, MED, 1.0 X 5 EA	51
5091-249	ST WIRE PASS STEEL BURS MED, 2 X 1MM 5 EA	51
5091-248	ST WIRE PASS STEEL BURS, MED, 5 EA	51
T121	STAPLE PRY	22
T122	STAPLER SEATER	22
T210	STAPLIZER AUTOCLV CASE	22
T100	STAPLIZER HANDPC	22
T123	STAPLIZR WIDE GAUG ASY	22
PRO2075	STD HUDSON DRILL	13
PRO2065	STD HUDSON REAMER	13

Cat. No.	Description	Page No.
5071-180	STER OSC BLD 10 X 85 X 1.27MM 5 EA	29, 33
5071-187	STER OSC BLD 19.5 X 71 X 0.8MM 5 EA	40, 42
5071-188	STER OSC BLD 19.5 X 80 X 0.8MM 5 EA	40, 42
5071-185	STER OSC BLD 19.5 X 80 X 0.9MM 5 EA	29, 30
5071-181	STER OSC BLD 19.5 X 86 X 1.27MM 5 EA	29, 33
5071-184	STER OSC BLD 19.5 X 90 X 1.2MM 5 EA	29, 32
5071-120	STER OSC BLD 19.5 X 95 X 0.9MM 5 EA	29, 31
5071-123	STER OSC BLD 19.5 X 95 X 1.27MM 5 EA	29, 34
5071-196	STER OSC BLD 25.4 X 0.9 X 90MM 5 EA	29, 31
5071-121	STER OSC BLD 25.4 X 95 X 0.9MM 5 EA	29, 31
5071-124	STER OSC BLD 25.4 X 95 X 1.27MM 5 EA	29, 35
5071-186	STER OSC BLD 32 X 64 X 0.8MM 5 EA	40, 41
5071-230	STER REPEAT STERNTRY BLD, 66 X 40MM 5 EA	68, 69
5071-228	STER REPT STERNTRY BLD, 44.5 X 4MM 5 EA	68, 69
5052-135	STER RPLCMNT BLADE/STRYKER RECIP 5 EA	45
5023-182	STERILE ACL BLD 19 X 41 X .4MM 5 EA	47
5023-183	STERILE ACL BLD 9.5 X 25.5 X .4MM 5 EA	47
5023-184	STERILE ACL BLD 9.5 X 41 X .4MM 5 EA	47
5023-410	STERILE GRAFT HARVESTING BLADE 10 X 20MM	48
5023-411	STERILE GRAFT HARVESTING BLADE 11 X 20MM	48
5023-412	STERILE GRAFT HARVESTING BLADE 12 X 20MM	48
5023-413	STERILE GRAFT HARVESTING BLADE 13 X 20MM	48
5023-405	STERILE GRAFT HARVESTING BLADE 5 X 20MM	48
5023-406	STERILE GRAFT HARVESTING BLADE 6 X 20MM	48
5023-407	STERILE GRAFT HARVESTING BLADE 7 X 20MM	48
5023-408	STERILE GRAFT HARVESTING BLADE 8 X 20MM	48
5023-409	STERILE GRAFT HARVESTING BLADE 9 X 20MM	48
5023-102	STERILE MC INTRA-ORAL BLD 11.5 X 12 X .4MM	49
5023-101	STERILE MC INTRA-ORAL BLD 11.5 X 7 X .4MM	49
5023-104	STERILE MC INTRA-ORAL BLD 5 X 12 X .4MM	49
5023-103	STERILE MC INTRA-ORAL BLD 9 X 12 X .4MM	49
5071-573	STERILE OSC BLD 18.5 X 90 X 1.26, 1.26MM 5 EA	29, 32
5071-575	STERILE OSC BLD 90 X 31 X 1.26 X 1.26MM 5 EA	29, 33
5072-185	STERILE REPL BLADE/STRYKER 2108-185	36, 38
5072-218	STERILE REPL BLADE/STRYKER 2108-218	36, 37
5072-195	STERILE REPL BLD/STRYKER COATED, 19.5 X .9 X 80MM	36, 37
5059-006	STERNUM SAW BLADE GUARD	20
5059-031	STERNUM SAW BLADE NONSTERILE	68
5059-031-01	STERNUM SAW BLADE NONSTERILE 50 PACK	68
5059-005	STERNUM SAW HANDPIECE(PNEUM) W/O HOSE	20
5059-007	STERNUM SAW WRENCH	20
5071-576	STRL LARGE BN BLD 16.5 X 95 X 1.27MM 5 EA	29, 34
5058-001	SURGAIRTOME TWO HANDPIECE W/O HOSE	16, 24
5058-000	SURGAIRTOME TWO KIT	16
5053-074	THROTTLE CLIP	16
1387-022	TISSUE RETRACTOR GUARD	14, 51, 52
E9415A	TUBING & TIP E9010 DRILL W/IRRIG 5 EA	17
E9417	TUBING, 3.7MM BLD IRRIG FOR E9000 6 EA	17
E9416	TUBING, 4.2MM BLD IRRIG FOR E9000 6 EA	17
E9414	TUBING, E9000 DRILL 5 EA	17
7020-003	ULTPWR PERFORATOR DRIVE W/O HOSE	18, 24, 25
7020-050	ULTPWR STOR/AUTOCLAVE CASE, COMPLETE	24
7020-052	ULTPWR STOR/AUTOCLAVE CASE, NEURO	25
7020-022	ULTRAPOWER® 90 DEG ANGLE ATTACHMENT, LIK	18, 24, 25
7020-041	ULTRAPOWER ATTACHMENT SPRAY	24, 25
7020-045	ULTRAPOWER FOOT CONTROL W/HOSE	18, 24, 25
7020-001	ULTRAPOWER HI-SPEED DRILL W/O HOSE	18, 24, 25
7020-040	ULTRAPOWER KEY WRENCH	24, 25
7020-023	ULTRAPOWER® KEYLESS 20D ANG ATT	18, 24, 25

Alphabetical Index



Cat. No.	Description	Page No.
7020-024	ULTRAPOWER KEYLESS XL 20D ANGLE	18, 24, 25
7020-012	ULTRAPOWER L BUR GUARD, MUST/LIKE MDS-M	18, 24, 25, 61 – 65
7020-016	ULTRAPOWER LARGE REV EXT BLUE/LIKE MDS-R	18, 24, 25, 61, 62, 64
7020-002	ULTRAPOWER LO-SPEED DRILL W/O HOSE	18, 24, 25
7020-019	ULTRAPOWER LONG NEURO GUIDE, BR/LIKE	18, 24, 25, 60
7020-011	ULTRAPOWER MED BUR GUIDE, CPR/LIKE MDS-O	18, 24, 25, 61 – 65
7020-018	ULTRAPOWER MEDIUM NEURO GUIDE, GR/LIKE	18, 24, 25, 60
7020-015	ULTRAPOWER MEDIUM REV EXTPURP/LIKE MDS-R	18, 24, 25, 61, 62, 64
7020-046	ULTRAPOWER NEURO BUR STORAGE CAB	17, 24, 25
7020-047	ULTRAPOWER REV BUR STORAGE CABINET	24, 25
7020-010	ULTRAPOWER SH BUR GUIDE, RED/LIKE MDS-X	18, 24, 25, 61 – 65
7020-017	ULTRAPOWER SHORT NEURO GUIDE, BL/LIKE M	18, 24, 25, 60
7020-051	ULTRAPOWER STOR/AUTOCLAVE CASE, BASIC	25
7020-014	ULTRAPOWER, SHORT REV EXTTEAL/LIKE MDS-T	18, 24, 25, 61 – 64
7020-013	ULTRAPOWER, XL BUR GUARD, LIME/LIKE MDS A	18, 24, 25, 61 – 65
E306	UNIVERSAL AUTOCLAVE CASE	23
5052-010	UNIVERSAL HOSE, 10'	8, 21, 24, 25, 27
5052-016	UNIVERSAL HOSE, 15'	8
5053-019	WIREDRIVER 100 CHUCK ADAPTOR	16
5053-124	WIREDRIVER BRUSH	23
5053-123	WIREDRIVER WIRE GUARD	16
X40B	X-LONG BARREL CAR BUR	52
X45C	X-LONG CONE CARBIDE BUR	53
X60R	X-LONG ROUND CARBIDE BUR	51
X10D	X-LONG ROUND DIA BUR	51
X55B	XLG, BRL OVAL, 5.5 X10 BUR	52
5071-229	XTER REPT STERNTMY BLD, 54.5 X 4MM 5 EA	68
1375-040	Y CONNECTOR	8

CONMED CORPORATION PRODUCT AREAS:

ARTHROSCOPY • ELECTROSURGERY • ENDOSCOPY • ENDOSURGERY • GASTROENTEROLOGY • INTEGRATED SYSTEMS • PATIENT CARE • POWERED INSTRUMENTS • PULMONOLOGY



11311 Concept Boulevard
Largo, FL 33773-4908
(727) 392-6464
Customer Service: 1-800-237-0169
FAX: (727) 399-5256
International FAX: +1 (727) 397-4540
email: customer_service@linvatec.com
www.linvatec.com
© 2011, 2010 Linvatec Corporation, a subsidiary of CONMED Corporation, 03/2011, CCA 9030 Rev 2