

Skytron Model 6500 Surgical Table

SKYTRON

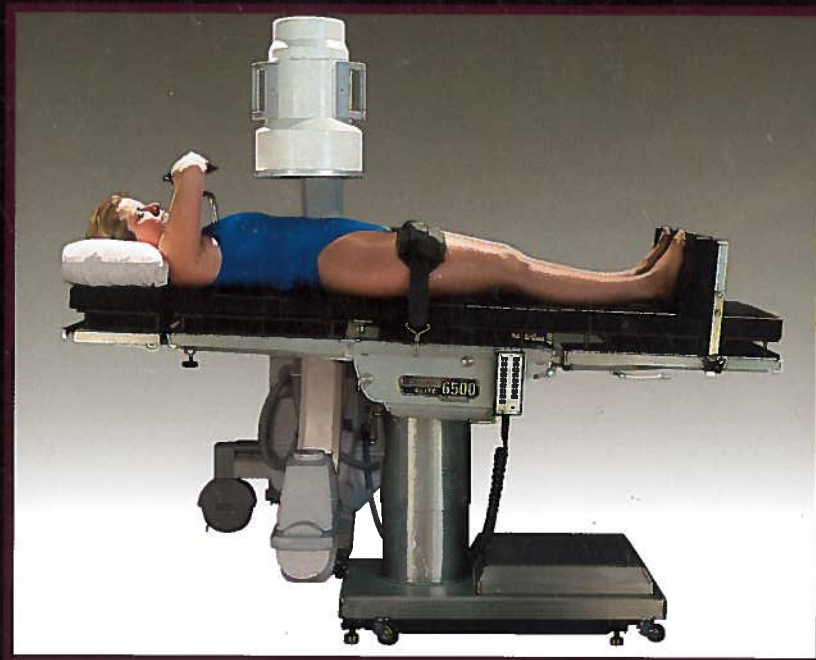

With exclusive rotating top
for maximum image
amplification and surgeon access.

Focusing on quality since 1972

Skytron has been a leader in improving hospital efficiency since the company was founded in 1972. Our product lines – which include lighting systems, surgical tables, utility arms, ultrasonic cleaners, washer decontaminators, and stainless steel equipment – have achieved a reputation for high quality and uncommonly reliable performance in medical facilities throughout North America. Equally important, we provide complete technical support, and are experienced in helping hospitals develop alternative financing programs.

We welcome the opportunity to demonstrate how Skytron can serve you.

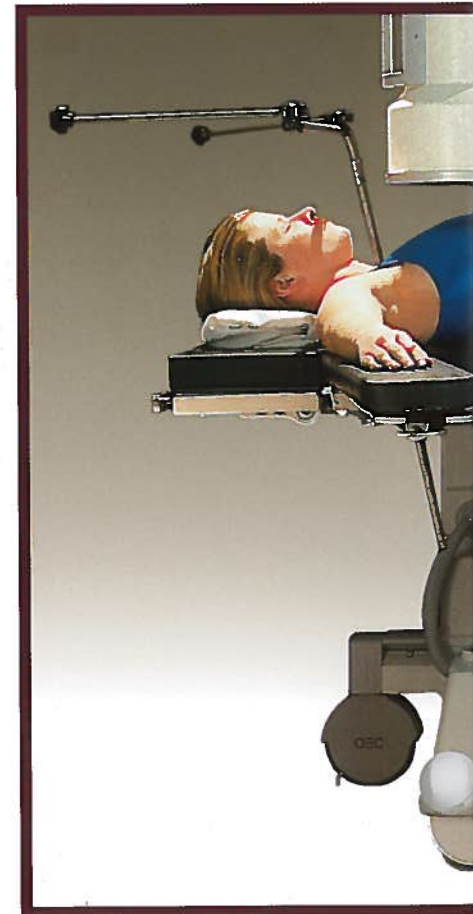
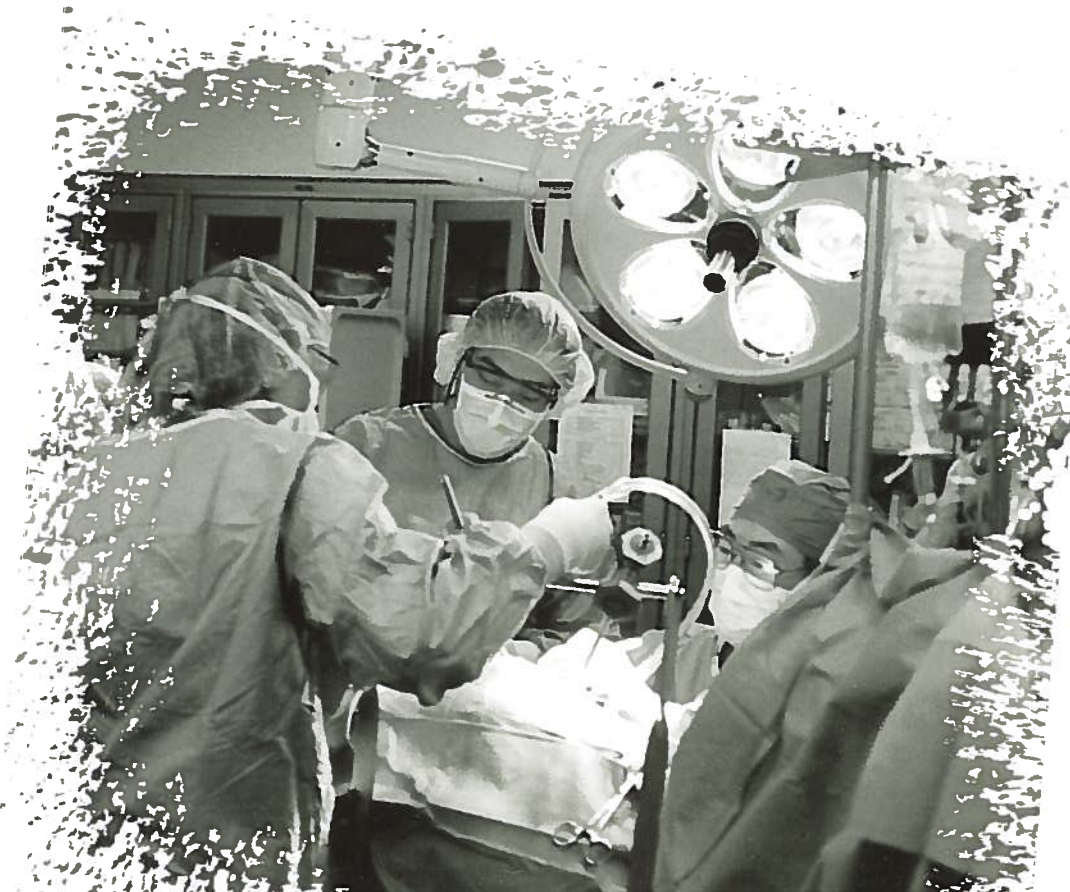

Designed for flexible patient positioning, unobstructed Image Amplification and enhanced surgeon comfort.

Uncommon flexibility makes the 6500 unequalled for general purpose surgery. The exclusive 180° rotating top feature allows unobstructed C-arm and microscope coverage.

Additionally, it eliminates conflicts between surgeon and anesthesiologist during head-end procedures, and provides ample leg room for surgeons who prefer to sit during procedures.

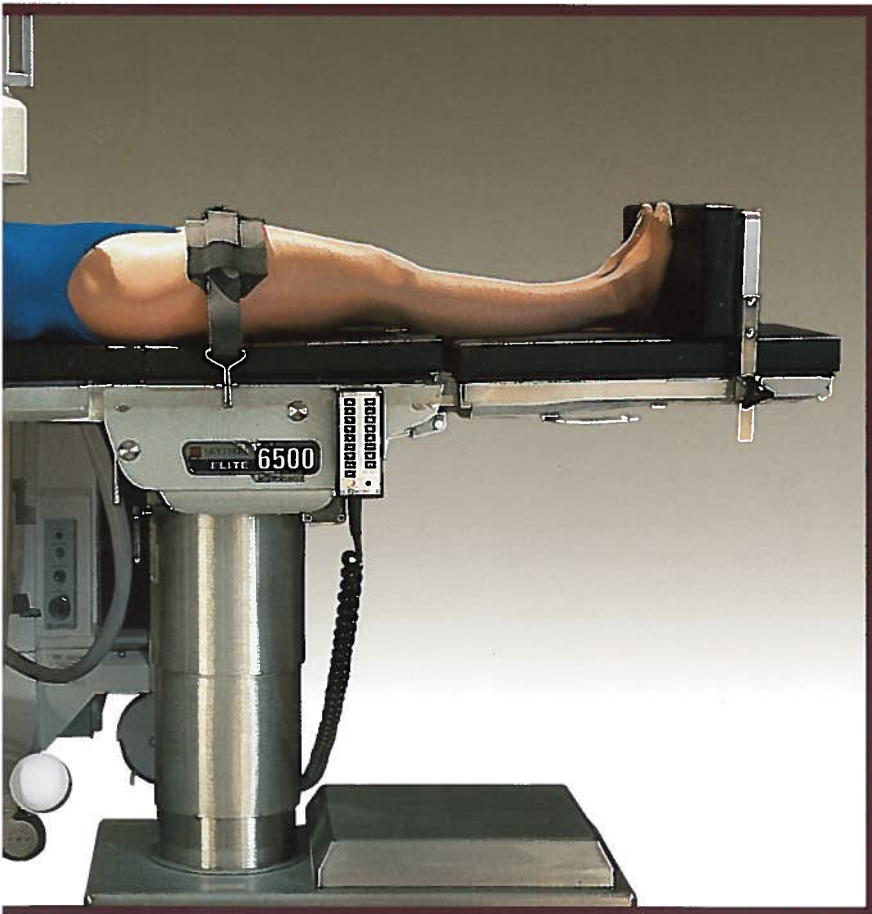

- **Greater table articulation capacity** assures proper positioning of patient for all general and most specialty procedures.
- **Patient orientation is always correct** with respect to the table controls. The head is always at the head end whether the table is in the standard or rotated configuration.
- **Easy to use, one-touch pendant** with return-to-level provides instant control of all table functions.
- **The greatest height adjustment range** of any general purpose table allows a comfortable working height whether the surgeon prefers to sit or stand.
- **Patients weighing up to 500 lbs.** can be lifted and fully articulated whether the top is in the standard or rotated configuration.
- **Exclusive removable leg section** provides improved access during perineal approach. Activated by the pendant control, the powered leg section moves 105° downward and 20° upward.

Instant table control at the touch of a finger.

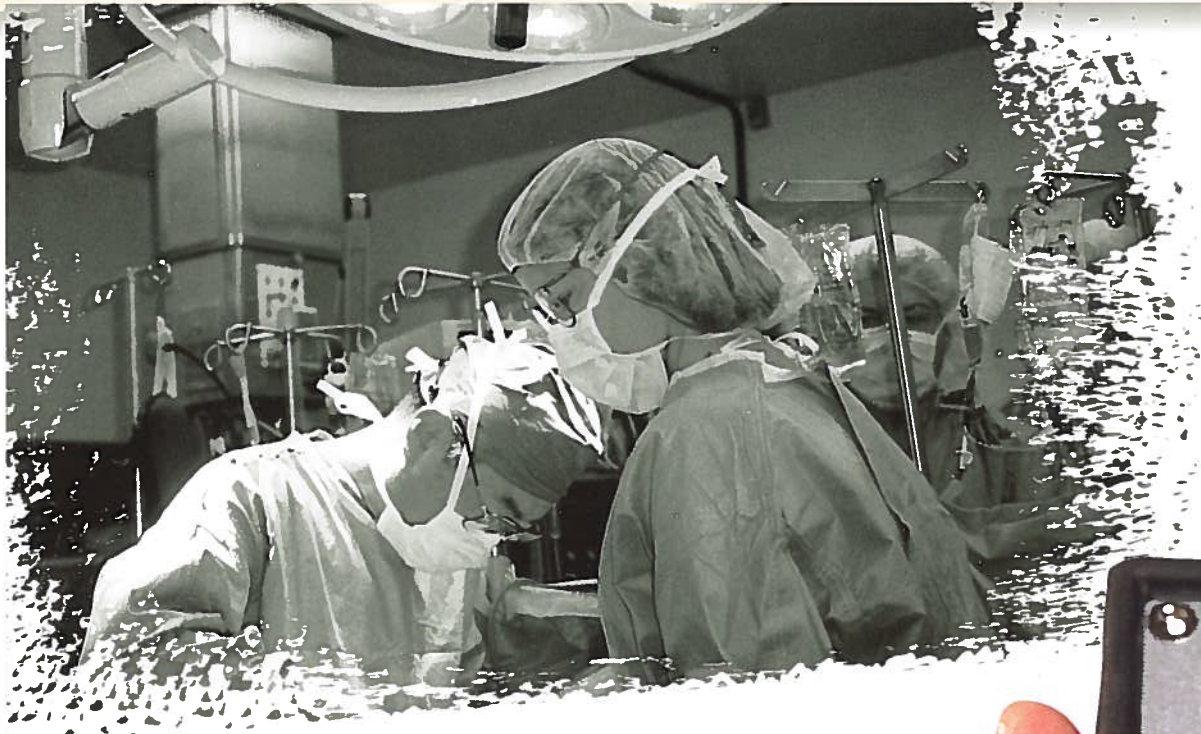

It's simply the easiest pendant to use from any spot around the table— just touch a button and you get smooth, instant response. It's also ruggedly built to withstand daily use and abuse. Unlike pendants constructed of plastic, Skytron's steel housing is virtually indestructible.

- **Easy to use, one-touch operation** instantly controls all height, articulation and kidney bridge functions.
- **Anatomically-correct return to level feature.**
- **Controls are always correct** with respect to patient orientation. Because the patient rotates with the top, there is no need to re-orient controls when the top is rotated.
- **Recessed buttons** eliminate the possibility of accidental activation.
- **Water-resistant steel housing** is more durable than plastic.
- **Brakes automatically lock** when any button is pushed.
- **Manual brake release function.**
- **Can be used in conjunction** with optional foot control.



500 lb. lift and articulation capacity!

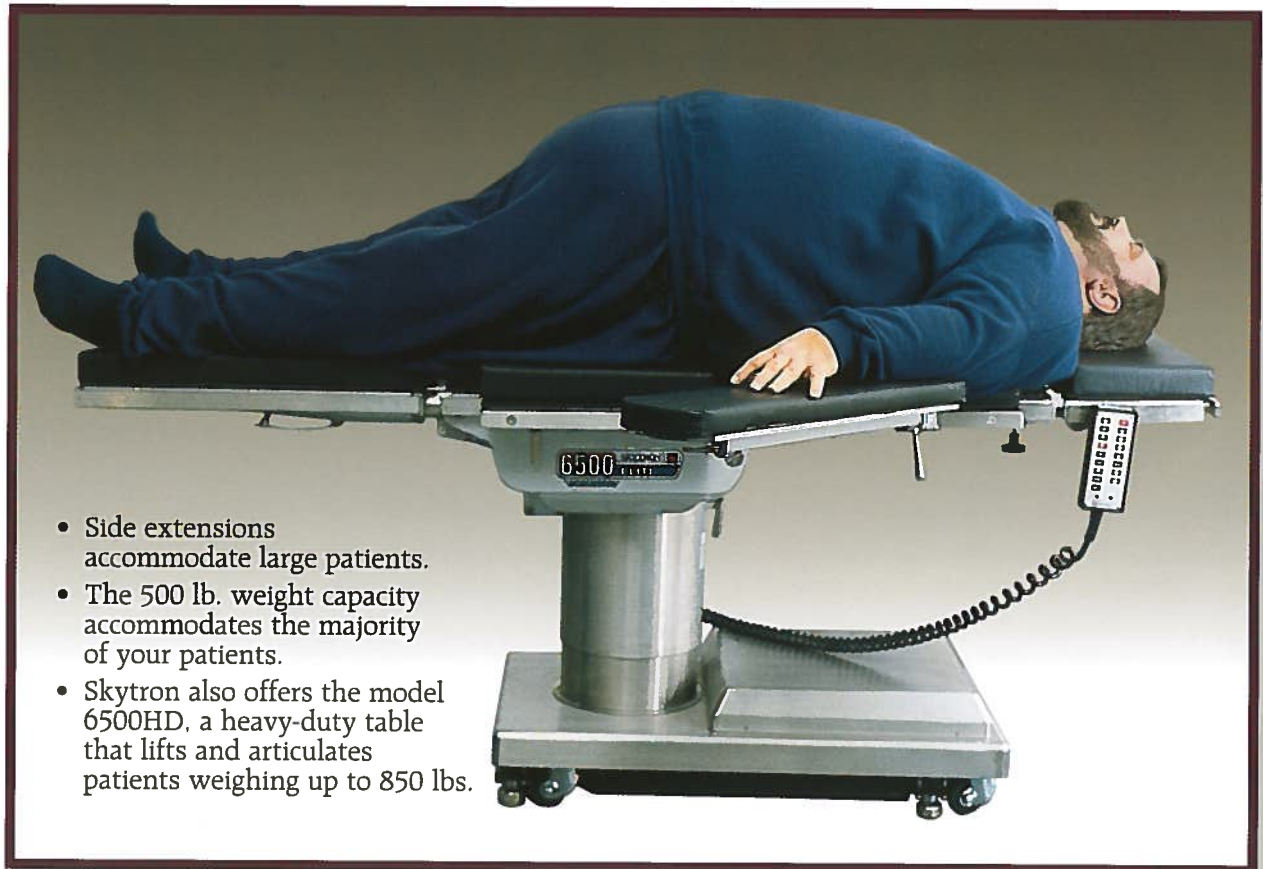

- Side extensions accommodate large patients.
- The 500 lb. weight capacity accommodates the majority of your patients.
- Skytron also offers the model 6500HD, a heavy-duty table that lifts and articulates patients weighing up to 850 lbs.

While many suppliers claim to have a 500 lb. capacity, only Skytron tables have the true ability to lift and fully articulate a 500 lb. patient, even with the top rotated 180 degrees.

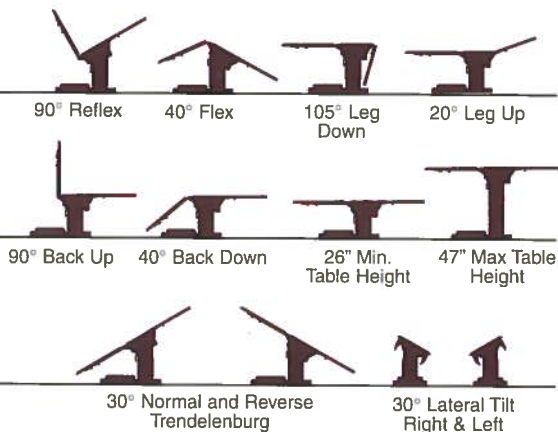

“The Skytron 6500 table not only has tremendous positioning flexibility, but it provides us with peace of mind knowing that we have a table that can safely handle our larger patients.”

– William J. Duffy,
 Director, Perioperative Services
 Evanston Northwestern Health Care
 Evanston, Illinois

Maximum Positioning Capability

No other general purpose surgical table matches the height range and articulation capabilities of the 6500.

- **Exceptional articulation range** and full-body Image Amplification coverage accommodates today's—and tomorrow's—surgical procedures.
- **The top can be positioned at any height from 26" to 47" (49" with x-ray top)** for surgeon comfort whether sitting or standing.
- **30° of tilt and 30° Trendelenburg** allows better organ retraction for minimally invasive surgery.

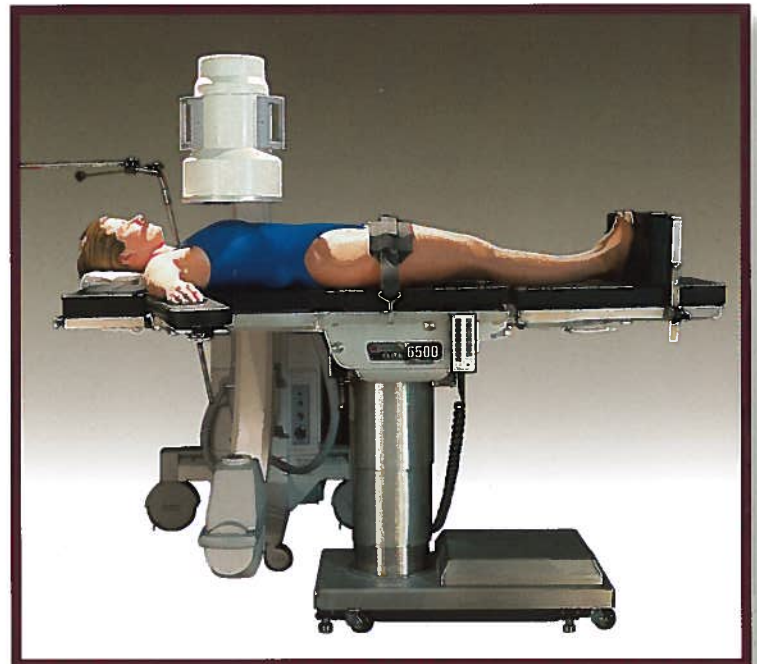

Cardiovascular. Accessories: 6-020-04 "L" type Anesthesia Screen with Adjustable Wings; (2) 2-010-02 + 2-010-02-2P Standard Armboards with 2" pads; 6-010-41-V Restraint Strap; 4-030-02-B + 4-030-02-2P 8" Foot Extension with 2" Pad.



Neurosurgery. Accessories: (2) 2-020-01-1 Raised Armboard; (2) 6-040-03 Tri-Clamps; 6-010-41-V Restraint Strap; 4-030-02-B + 4-030-02-2P 8" Foot Extension with 2" Pad.

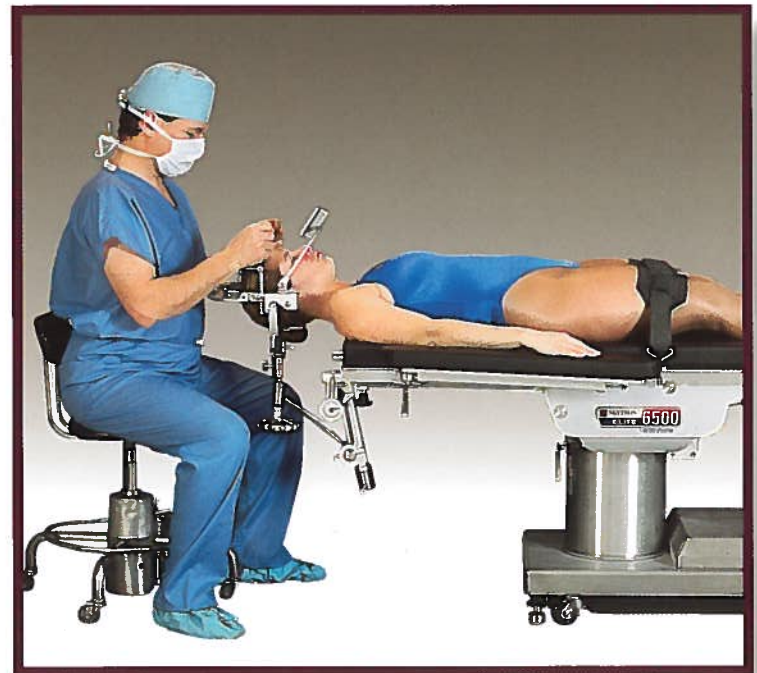

Neurosurgery Accessories: 7-980-02 Multi-Purpose ("Sugita") Head Frame; (2) 2-010-02 + 2-010-02-2P Standard Armboards with 2" Pads; 6-010-41-V Restraint Strap; 4-030-02-B+ 4-030-02-2P 8" Foot Extension with 2" Pad.

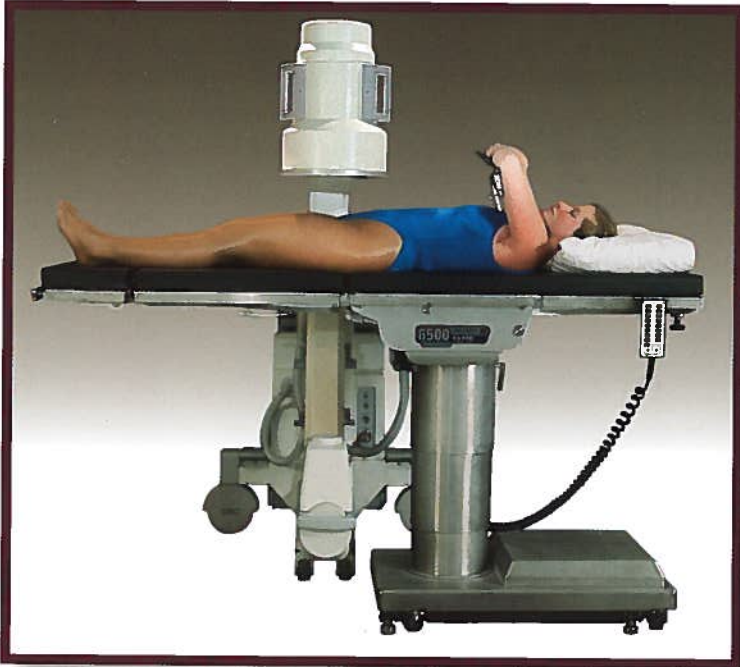

Hip Revision Accessories: 2-020-01-1 Raised Armboard; 6-040-05 Clark Socket; 2-010-02 + 2-010-02-2P Standard Armboard with 2" Pad.



Shoulder Arthroscopy Accessories: 3-040-04 Power Lift Shoulder Positioner; (2) 2-020-01-1 Raised Armboards; (2) 6-040-05 Clark Sockets; 6-010-41-V Restraint Strap; 4-030-02-B + 4-030-02-2P 8" Foot Extension with 2" Pad; 3-010-01 Chest and Waist Supports.

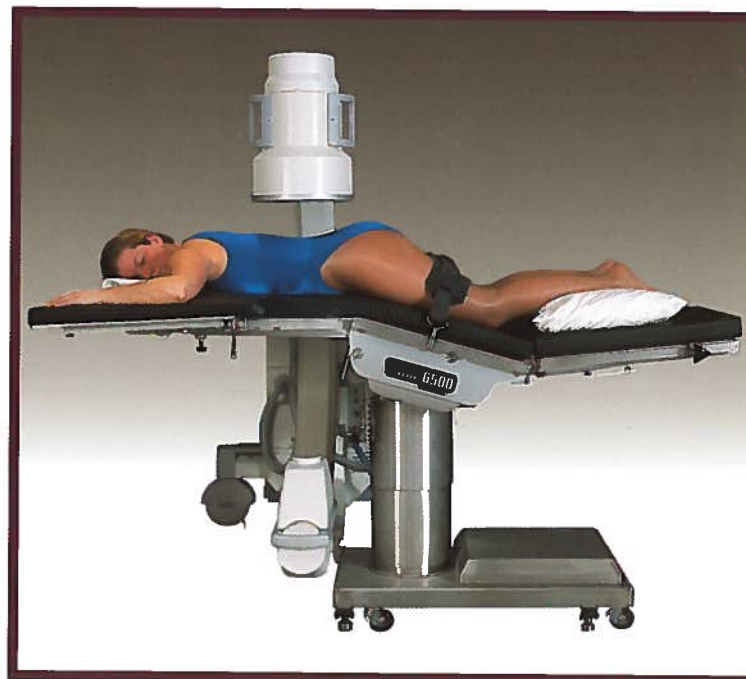

Lumbar Accessories: (2) 2-010-02 + 2-010-02-2P Standard Armboards with 2" Pad; 6-010-41-V Restraint Strap.

Maximum Positioning Capability

“The reliability and exceptional quality of the 6500 table has made our O.R. staff want all of our O.R. rooms equipped with Skytron.”

*– Arlene Maloney,
Service Manager
Good Samaritan
Regional Medical Center
Phoenix, Arizona*



Abdominal Accessories: 6-020-04 "L" Type Anesthesia Screen with Adjustable Wings; (2) 2-010-02 + 2-010-02-4P Standard Armboards with 4" Pads; 6-010-41-V Restraint Strap; 4-030-02-B + 4-030-02-2P 8" Foot Extension with 2" Pad; 5-010-09-B Radiographic Top.

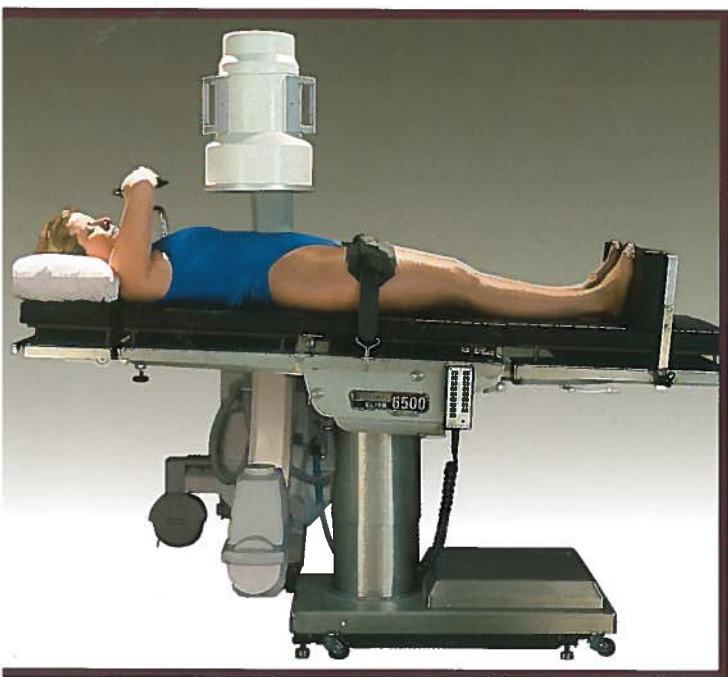

Gall Bladder Accessories: 2-020-01-1 Raised Armboard; 6-040-05 Clark Socket; 2-010-02 + 2-010-02-4P Standard Armboard with 4" Pad; 6-010-41-V Restraint Straps; 4-030-02-B + 4-030-02-2P 8" Foot Extension with 2" Pad; 5-010-09-B Radiographic Top.

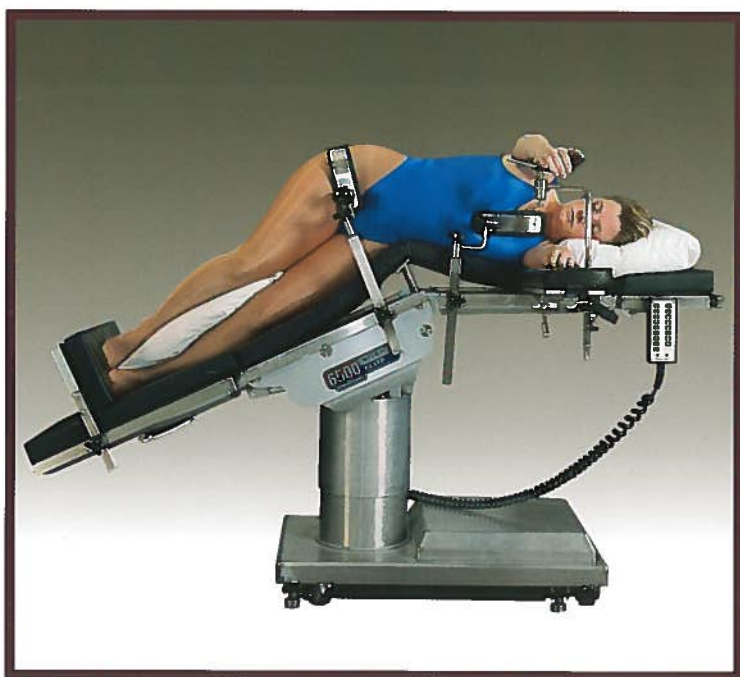

Thoracic/Kidney Accessories: 2-010-2 + 2-010-02-2P Standard Armboard with 2" pad; 2-020-01-1 Raised Armboard; 6-040-05 Clark Socket; 3-010-01 Chest and Waist Supports; 4-030-02-B + 4-030-02-2P 8" Foot Extension with 2" Pad.

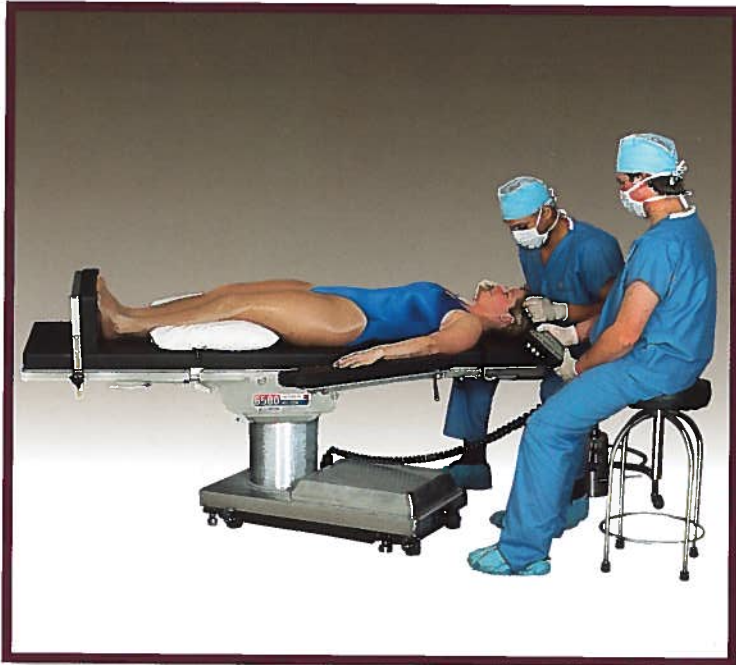

Unequaled C-Arm Accessibility

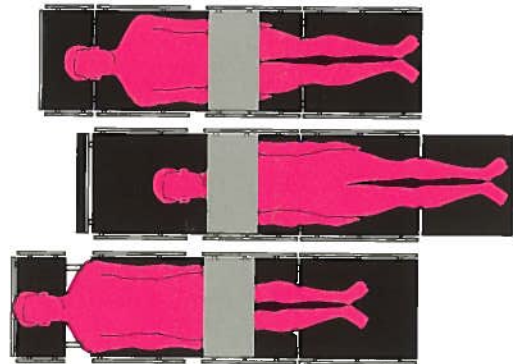

- Top rotation, exceptional patient positioning capability, and the use of a simple 18" leg extension combine to provide unequalled full-body Image Amplification coverage essential for today's (and tomorrow's) surgical techniques.

Ophthalmic Accessories: 2-010-02 + 2-010-02-2P Standard Armboards with 2" Pads; 4-030-02-B + 4-030-02-2P 8" Foot Extension with 2" Pad; Optional: 7-010-07 Narrow Head Section (not shown).

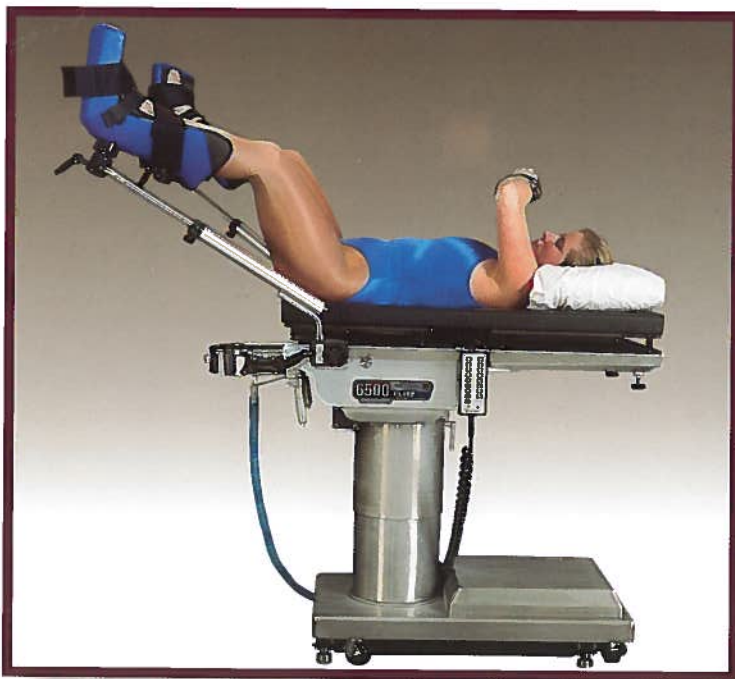

Cysto/GYN Accessories: 2-010-02 + 2-010-02-4P Standard Armboard with 4" Pad; 2-020-01-1 Raised Armboard; 6-040-05 Clark Socket; 4-080-01-1 Ankl-Lock III Stirrups; (2) 6-040-03 Tri-Clamps; 5-010-09-B Radiographic Top; 4-040-03 Uro Drain Tray.



Ureteroscopy Accessories: 2-010-02 + 2-010-02-4P Standard Armboard with 4" pad; 2-020-01-1 Raised Armboard; 6-040-05 Clark Socket; 4-090-02-1 Levitator Stirrups; (2) 6-040-05 Clark Sockets; 4-040-14 Urocatcher II; 4-040-14-1 Sterile Pouch; 5-010-09-B Radiographic Top.

Feature for feature the best general purpose surgical table for your OR.

Head section can be used as a foot extension during transfer.

Optional snap-on raised radiographic top permits fast, easy side loading of full-size X-Ray cassettes.

Radiolucent top permits clear, sharp image amplification.

Adjustable head section can be extended to accommodate taller patients.

Full width quick-release bar on manually operated head section is easy to locate in emergency situations.

Standardized side rails accept most accessories.

Built-in power kidney bridge provides an additional 5" of lift.

Stainless steel base and column are durable and easy to clean.

Narrow base design provides toe space clearance to eliminate surgeon back strain.

Optional battery power with removable power cord.

4-point brake system maximizes table stability.

Back-up controls on battery models for emergency situations.

Exclusive 180° rotating top facilitates C-arm access, patient positioning and surgeon comfort.

Large perineal cut-out for better access.

Exclusive removable leg section allows easy, unobstructed perineal access.

Unique frame construction eliminates cross-members and allows unobstructed C-arm access.

One-touch pendant controls all functions from any point around the perimeter of the table.

500 lb. lift and articulating capability.

Fully mechanical brake release.

Swivel casters permit side movement for ease of cleaning between cases.

Self-leveling brakes automatically compensate for uneven floors and assure a solid work surface.

Optional three-function foot control.

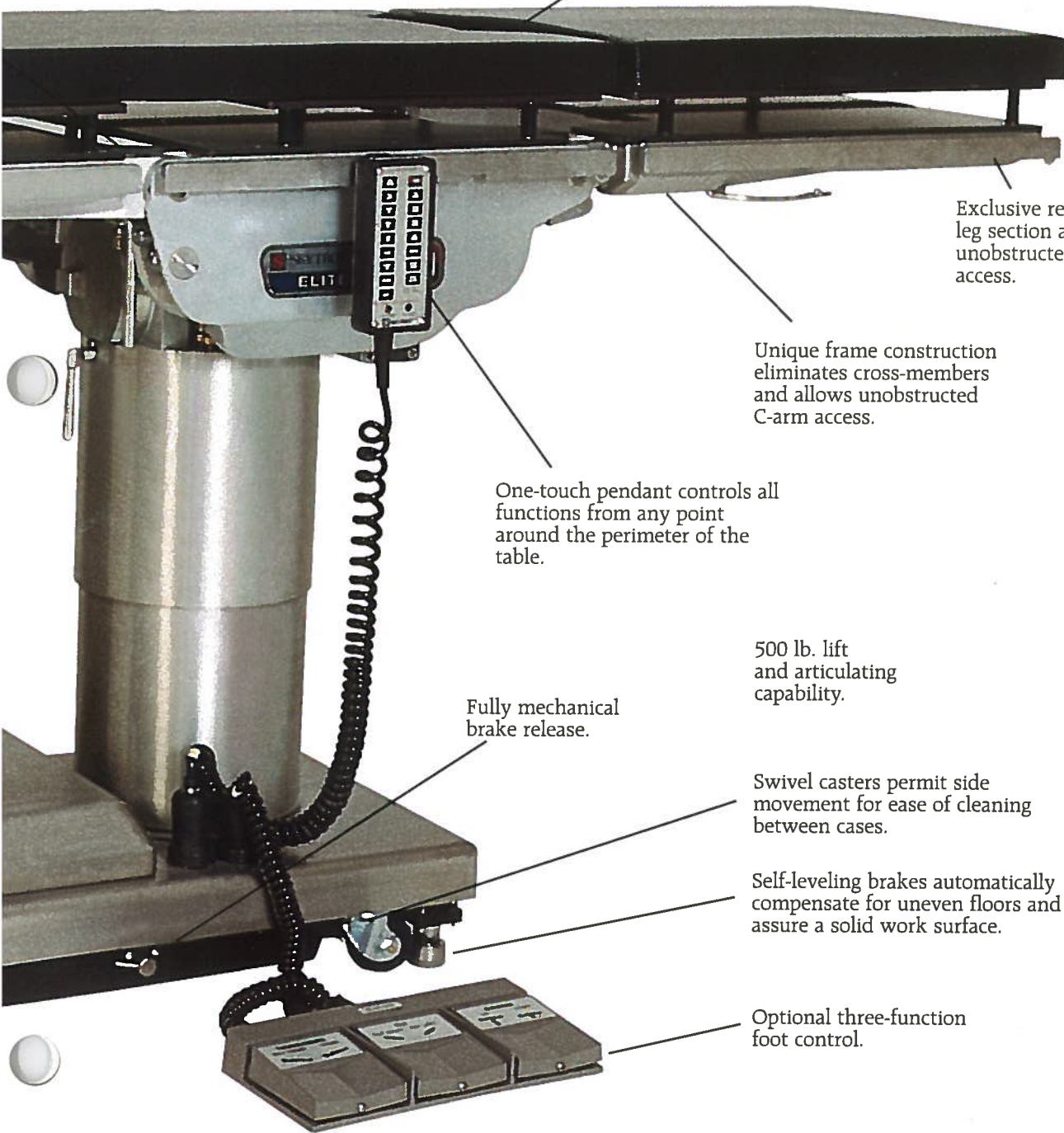

Model 6500 General Purpose Surgical Table Specifications

Warranty

Standard warranty covers parts and labor for two full years.

Installation/Maintenance

Installation supervision is provided. Preventive maintenance and service are available.

In-Service Training

On-site surgical staff training is provided by your local Skytron representative.

A video cassette program is available at no charge to train hospital personnel in the operation and care of the Model 6500.

Electrical Specifications

Power requirements: 120 VAC, 60Hz 450 Watts
 Current leakage: Less than 100 micro amps
 Power cord: 15 feet with hospital grade connector

Specifications

Electro-hydraulic operating room table shall operate at 120v, 60Hz, 1 phase and be protected by 2 internal 10 amp fuses. A 15-foot power cord with hospital grade plug shall be provided. Conductive casters shall allow side movement for ease of operation and cleaning. Unit is to be equipped with standardized side rails and a four-point, push-button operated braking system for safety and stability. A pendant-type control unit shall be operable from any point around the entire perimeter of the table. The table is to lift and fully articulate a 500 lb. patient. Entire table top shall be radiolucent to provide image intensification capability. Positioning capabilities to include: lateral tilt of 30°; Trendelenburg and reverse Trendelenburg of 30°; Kidney bridge elevation of 5°; back up of 90°; back down of 40°; height adjustment range of 26" to 47" (49" with x-ray top); leg section down 105°, leg section up 20°; 180° top rotation. Unit is also provided with 40° flex and 90° reflex function control button. Removable leg-section table is to be Skytron Model 6500 (Line Power); Skytron Model 6500B (Battery Power).

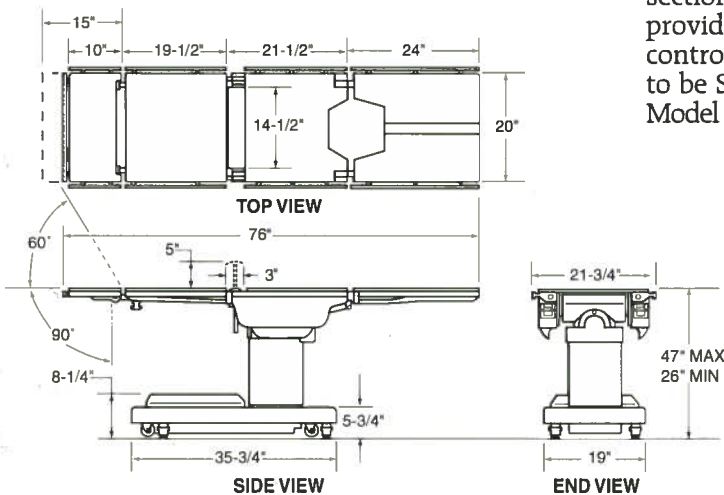

C-Arm is provided courtesy of OEC Medical Systems



Local Representative