

 The *MicroChoice*<sup>®</sup> Electric  
Powered Surgical System

PROVIDING YOU WITH  
VERSATILITY AND  
POWER TO PERFORM



Hall<sup>®</sup> Surgical



# The MicroChoice® Electric Powered Surgical System

for small bone and oral maxillofacial procedures



Unique Mode Select capability at the press of a button on the handpiece from within sterile field allows you to change maximum speed and irrigation flow to meet the needs of every phase of a procedure

## Built For Your Needs

- Powerful, yet quiet motor
- Each handpiece fully encapsulated to protect against surgical environment fluid and moisture
- Instrument profile ensures a secure grip, maximum visibility, and easier maneuverability in confined surgical sites
- Handpiece speed held constant during increased demand with a closed-loop feedback system
- Keyless collets to easily change burs and saw blades
- Lightweight handpieces
- Same cord fits all handpieces



### The **MicroChoice** Controller

» Catalog Number MC5020

Controller manages the drills, saws, wiredriver/fixation drill and irrigation system as a formidable microsurgery tool. Controller digital display navigates you through options and identifies handpiece and selected parameters

### The **MicroChoice** Foot Control

» Catalog Number 5020-053

Choose your method of control with a handpiece lever, extra-long lever or foot control; lever removes when using the foot control

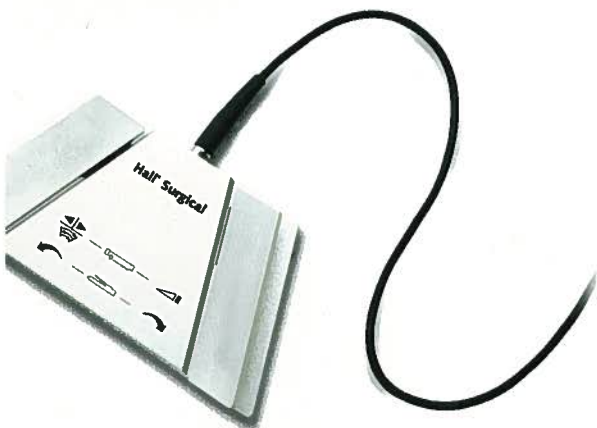

Vast selection of high-quality burs and saw blades—Choose individual pieces or a kit

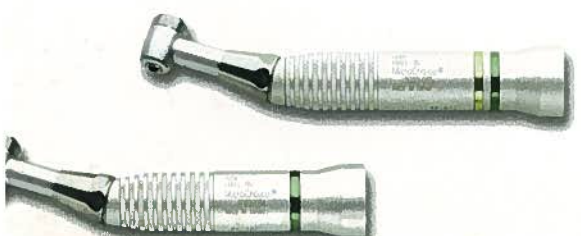



The **MicroChoice** 1/4" High Torque Jacobs Chuck

» Catalog Number 5020-042



The **MicroChoice** 1/4" Jacob Chuck

» Catalog Number 5020-041



The **MicroChoice** Sagittal Saw

» Catalog Number 5020-043



The **MicroChoice** 5/32" High Torque Jacobs Chuck

» Catalog Number 5020-031



The **MicroChoice** 5/32" Jacobs Chuck

» Catalog Number 5020-030



The **MicroChoice** Universal Drill Attachment

» Catalog Number 5020-029



The **MicroChoice** Pindriver Attachment

» Catalog Number 5020-032



The **MicroChoice** Wiredriver Attachment

» Catalog Number 5020-028



The **MicroChoice** Wiredriver / Fixation Drill

» Catalog Number 5020-027

® **Surgical**

**Hall® Surgical**

Modular handpiece-wiredriver, pindriver, drill



Sophisticated Array of Powerful Capabilities—  
Low, medium, and high speed drills

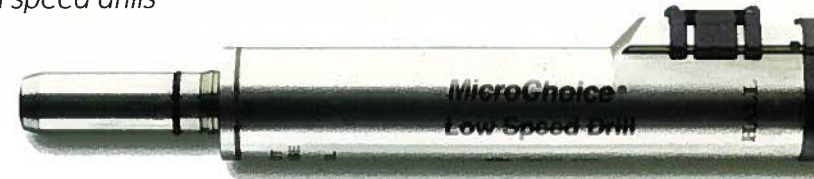

The **MicroChoice** Low Speed Drill  
» Catalog Number 5020-026



The **MicroChoice** Medium Speed Drill  
» Catalog Number 5020-021



The **MicroChoice** High Speed Drill  
» Catalog Number 5020-025

Oscillating, reciprocating, and sagittal saws

Variable speed lever regulates  
instrument performance and  
irrigation delivery



The **MicroChoice** Oscillating Saw  
» Catalog Number 5020-024



The **MicroChoice** Reciprocating Saw  
» Catalog Number 5020-023



The **MicroChoice** Sagittal Saw  
» Catalog Number 5020-022

High Torque Jacobs Chuck  
Replacement w/key  
Irrigator Attachment  
High Torque Jacobs Chuck Attachment  
Replacement 1/4" Jacobs Chuck Key  
Replacement 5/32" Jacobs Chuck Key  
Reciprocating Saw Attachment

**Choice Ordering Information**  
Choice Basic Shaver Handpiece  
Choice Micro Shaver Handpiece  
Choice Full-Function Shaver Handpiece

**Accessories**  
Irrigation System Cord  
Irrigation Pump (100-120 VAC)  
Irrigation Pump (220-240 VAC)  
Irrigation Flexible Tubing Set  
Irrigation Flexible Y Tubing Set  
Irrigation Flexible Tubing Set  
Irrigation Handpiece Clip  
Irrigation 20° Angle Bur Tip  
Irrigation XL 20° Angle Bur Tip  
Irrigation Medium Bur Tip  
Irrigation External 70° and 90° Angle Tip  
Irrigation Long Bur Tip  
Irrigation Internal 70° and 90° Angle Tip  
Irrigation Sagittal Saw Tip  
Irrigation Oscillating Saw Tip  
Irrigation Reciprocating Saw Tip  
Irrigation XL Bur Tip  
Irrigation Universal Irrigation Tip  
Irrigation Medium Bur Tip  
Irrigation Long Bur Tip  
Irrigation Extra-Long Bur Tip

**Accessories to MicroChoice**  
Irrigation Handpiece Cord  
Irrigation Cord to MicroChoice Controller Cord  
Choice Footswitch  
Choice Controller Stand  
Irrigation Cement Safe Slide  
Irrigation Handpiece Replacement Lever  
Irrigation Handpiece Lever  
Irrigation Power Cord (115 VAC)  
Irrigation Power Cord (230 VAC)  
Replacement Key for 1/4" Jacobs Chuck  
Replacement Key for 5/32" Jacobs Chuck  
Irrigation Handguard  
Irrigation Handpiece Brush

Reciprocating Saw	
Speed	0 to 100% in increments of 10%
Stroke	1/8 in. (2.54 mm)
High Speed Drill	
Speed	100,000 rpm Maximum
2,000 rpm	10,000 to 100,000 rpm in 10,000 rpm increments
Weight	2 in. oz.
Capacity	Exceeds 12 lbs. (5.4 kg)

**MICROCHOICE® ELECTRIC POWERED SURGICAL SYSTEM**

**MicroChoice Kit Configurations**

**5020-050 System Kit Includes:**

- MC5020 *MicroChoice* Controller (110-120 VAC) with L5039-003 AC Power Cord and MC5056 Handpiece Cord
- 5020-021 Medium Speed Drill
- 5020-022 Sagittal Saw
- 5020-023 Reciprocating Saw
- 5020-024 Oscillating Saw
- 5020-025 High Speed Drill
- 5020-027 Wiredriver/Fixation Drill
- 5020-028 Wiredriver Attachment
- 5020-029 Universal Drill Attachment
- 5020-030 5/32" Jacobs Chuck Attachment with L5044-999-053 Jacobs Chuck Key
- 5020-031 5/32" High Torque Jacobs Chuck Attachment with L5044-999-053 Jacobs Chuck Key
- 5020-060 Medium Bur Guard
- 5020-091 Sterilization Tray

**5020-051 Oral Surgery Kit Includes:**

- AC5020 *MicroChoice* Controller (110-120 VAC) with L5039-003 AC Power Cord and MC5056 Handpiece Cord
- 5020-025 High Speed Drill
- 5020-026 Low Speed Drill
- 5020-034 Dental Implant Drill Head
- 5020-035 Dental Implant Screw/Tap head
- 5020-053 *MicroChoice* Footswitch
- 5020-060 Medium Bur Guard
- 5020-092 Sterilization Tray

**5020-052 Dental Implant Kit Includes:**

- AC5020 *MicroChoice* Controller (110-120 VAC) with L5039-003 AC Power Cord and MC5056 Handpiece Cord
- 5020-026 Low Speed Drill
- 5020-034 Dental Implant Drill Head
- 5020-035 Dental Implant Screw/Tap Head
- 5020-053 *MicroChoice* Footswitch
- 5020-093 Sterilization Tray

**5020-049 Trauma Kit Includes:**

- AC5020 *MicroChoice* Controller (110-120 VAC) with L5039-003 AC Power Cord and MC5056 Handpiece Cord
- 5020-027 Wiredriver/Fixation Drill
- 5020-028 Wiredriver Attachment
- 5020-029 Universal Drill Attachment
- 5020-030 5/32" Jacobs Chuck Attachment with L5044-999-053 Jacobs Chuck Key
- 5020-031 High Torque Jacobs Chuck Attachment with L5044-999-053 Jacobs Chuck Key
- 5020-094 Sterilization Tray

**MicroChoice Controller**

- MC5020 *MicroChoice* Controller (110-120 VAC) with L5039-003 AC Power Cord and MC5056 Handpiece Cord
- MC5024 *MicroChoice* Controller 230 VAC with MC5056 Handpiece Cord and C7105 AC Power Cord 220-240 VAC

**Medium and High Speed Drill Ordering Information**

- 5020-021 *MicroChoice* Medium Speed Drill
- 5020-025 *MicroChoice* High Speed Drill

**Guards and Attachments for both Medium and High Speed Drills**

- 5020-060 Medium Bur Guard
- 5020-061 Long Bur Guard
- 5020-062 Extra-Long Bur Guard
- 5020-063 20° Angle Attachment
- 5020-064 20° Angle Attachment Extra-Long
- 5020-065 70° Contra-Angle Attachment with Surgical Head
- 5020-066 90° Angle Attachment
- 5020-067 Laminectomy Guard
- 5020-068 Tissue Retractor Guard
- 5020-069 70° Contra-Angle Attachment with Dental Head

**Low Speed Drill Ordering Information**

- 5020-026 *MicroChoice* Low Speed Drill
- 5020-034 Dental Implant Drill Head
- 5020-035 Dental Implant Screw/Tap Head

**Accessories for Low Speed Drill**

- 5020-074 Dental Attachment Cleaning Ring
- 5020-075 Low Speed Attachment Wrench

**Accessories Common to Low, Medium and High Speed Drills/Attachments**

- 1375-003 Bur Changer
- 1375-015 Bur Cleaning Brush
- 1375-037 Pana Spray
- 5053-008 Bur Rack

**Oscillating, Sagittal and Reciprocating Saws Ordering Information**

- 5020-024 *MicroChoice* Oscillating Saw
- 5020-022 *MicroChoice* Sagittal Saw
- 5020-023 *MicroChoice* Reciprocating Saw

**Modular Wiredriver/Fixation Drill Ordering Information**

- 5020-027 *MicroChoice* Modular Wiredriver/Fixation Drill
- 5020-028 Wiredriver Attachment
- 5020-029 Universal Drill Attachment
- 5020-030 5/32" Jacobs Chuck Attachment w/key

- 5020-031 5/32" High Torque Jacobs Chuck Attachment w/key
- 5020-032 Pin Driver Attachment
- 5020-041 1/4" Jacobs Chuck Attachment w/key
- 5020-042 1/4" High Torque Jacobs Chuck Attachment w/key
- L5044-999-52 Replacement 1/4" Jacobs Chuck Key
- L5044-999-53 Replacement 5/32" Jacobs Chuck Key
- 5020-043 Sagittal Saw Attachment

**Shaver Handpiece Ordering Information**

- MC9820 *MicroChoice* Basic Shaver Handpiece
- MC9840 *MicroChoice* Micro Shaver Handpiece
- MC9828 *MicroChoice* Full-Function Shaver Handpiece

**Irrigation Accessories**

- 5020-055 Irrigation System Cord
- 5040-039 Irrigation Pump (100-120 VAC)
- 5040-239 Irrigation Pump (220-240 VAC)
- 5040-120 Disposable Tubing Set
- 5040-128 Reusable Y Tubing Set
- 5040-129 Reusable Tubing Set
- 5040-130 Reusable Irrigation Handpiece Clip
- 5040-158 Reusable 20° Angle Bur Tip
- 5040-159 Reusable XL 20° Angle Bur Tip
- 5040-200 Reusable Medium Bur Tip
- 5040-201 Reusable External 70° and 90° Angle Tip
- 5040-202 Reusable Long Bur Tip
- 5040-203 Reusable Internal 70° and 90° Angle Tip
- 5040-205 Reusable Sagittal Saw Tip
- 5040-206 Reusable Oscillating Saw Tip
- 5040-207 Reusable Reciprocating Saw Tip
- 5040-208 Reusable XL Bur Tip
- 5040-219 Disposable Universal Irrigation Tip
- 5040-220 Disposable Medium Bur Tip
- 5040-222 Disposable Long Bur Tip
- 5040-228 Disposable Extra-Long Bur Tip

**Accessories Common to MicroChoice**

- MC5056 Handpiece Cord
- 5020-048 Micro E to *MicroChoice* Controller Cord
- 5020-053 *MicroChoice* Footswitch
- 5020-054 *MicroChoice* Controller Stand
- 5020-057 Replacement Safe Slide
- 5020-058 Handpiece Replacement Lever
- 5020-059 XL Handpiece Lever
- L5039-003 AC Power Cord (115 VAC)
- C7105 AC Power Cord (230 VAC)
- L5044-999-52 Replacement Key for 1/4" Jacobs Chuck
- L5044-999-53 Replacement Key for 5/32" Jacobs Chuck
- 5053-123 Wire Guard
- 5053-124 Cleaning Brush

Specifications	Oscillating Saw	Sagittal Saw	Reciprocating Saw
Operating Speed	25,000 cpm	20,000 cpm	17,000 cpm
Maximum Speed Settings	20 to 100% in increments of 10%	20 to 100% in increments of 10%	20 to 100% in increments of 10%
Stroke	8° arc	4° arc	1/10th in. (2.54 mm)

Specifications	5020-034 Dental Implant Drill Head	5020-035 Dental Implant Screw/Tap Head
Operating Speed	2,500 rpm Maximum	30 rpm Maximum
Maximum Speed Settings	250 to 2,500 rpm in 250 rpm increments	2 to 30 rpm in 2 rpm increments
Torque	15 in. oz.	Screw: 25 in. oz. Tap Forward: 55 in. oz. Tap Reverse: 60 in. oz.

Specifications	Medium Speed Drill	High Speed Drill
Operating Speed	25,000 rpm Maximum	100,000 rpm Maximum
Maximum Speed Settings	1,000 to 25,000 rpm in 2,000 rpm increments	10,000 to 100,000 rpm in 10,000 rpm increments
Torque	6 in. oz.	2 in. oz.
Bur Pull-Out Force	Exceeds 12 lbs. (5.4 kg)	Exceeds 12 lbs. (5.4 kg)

**Hall® Surgical**



11311 Concept Boulevard Largo, Florida 33773-4908

Phone: (727) 392-6464

Customer Service: (800) 925-4255

USA Fax: (727) 399-5256

International Fax: (727) 397-4540



# THE MICROCHOICE™ MEDIUM AND HIGH SPEED DRILLS







**HIGH SPEED DRILL** – A versatile handpiece with performance ideal for third-molar extractions and fine bone sculpting. The lever is removable, permitting optional use of an extra-long lever or the footswitch control.

**MEDIUM SPEED DRILL** – Designed for a wide variety of procedures, offering an impressive balance of speed and torque. When combined with our extensive offering of attachments and burs, the ideal surgical approach can be obtained.

5020-064 Extra-Long  
20° Angle Attachment

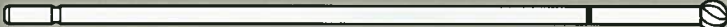
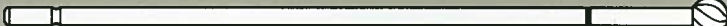
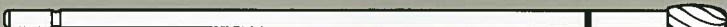
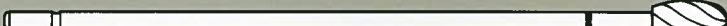

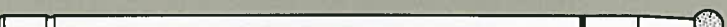
5020-062  
Extra-Long  
Bur Guard

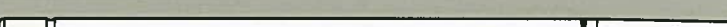
-   
5093-224  
Round 2.0mm
-   
5093-228  
Round 4.0mm
-   
5093-230  
Round 5.0mm
-   
5093-236  
Oval 4.0 X 8.0mm
-   
5093-238  
Oval 5.5 X 10.0mm
-   
5093-260  
Round Diamond 2.0mm
-   
5093-262  
Round Diamond 3.0mm
-   
5093-264  
Round Diamond 4.0mm
-   
5093-266  
Round Diamond 5.0mm
-   
5093-291  
Cylindrical 3.0 X 4.0mm

BURS ARE SHOWN AT ACTUAL SIZE  
5093-1XX Single Pack · 5093-2XX 5/Box

5020-063  
20° Angle  
Attachment



5020-061 Long  
Bur Guard

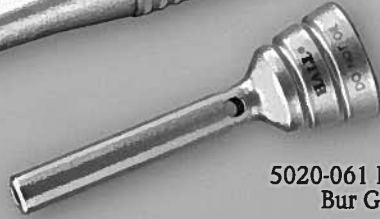

BURS ARE SHOWN AT ACTUAL SIZE  
5092-1XX Single Pack · 5092-2XX 5/Box



5092-203  
Straight 1.7 X 12.0mm



5092-204  
Straight 1.5 X 7.5mm



5092-206  
Tapered 2.0 X 7.5mm



5092-214  
Straight 2.0 X 19.0mm



5092-220  
Round 1.0mm



5092-222  
Round 1.5mm



5092-224  
Round 2.0mm



5092-226  
Round 3.0mm



5092-228  
Round 4.0mm



5092-230  
Round 5.0mm



5092-232  
Round 6.5mm



5092-236  
Oval 4.0 X 8.0mm



5092-238  
Oval 5.0 X 10.0mm



5092-247  
Wire Pass 1.0 X 19.0mm



5092-252  
Barrel 2.0 X 10.0mm



5092-254  
Barrel 4.0 X 10.0mm

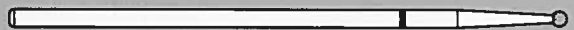

5092-260  
Round Diamond 2.0mm



5092-262  
Round Diamond 3.0mm



5092-264  
Round Diamond 4.0mm



5092-266  
Round Diamond 5.0mm

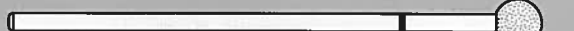

5092-268  
Round Diamond 6.0mm

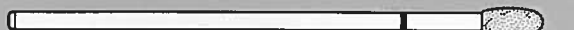

5092-270  
Oval Diamond 4.0 X 8.0mm



5092-274  
Rhinoplasty Diamond 2.0 X 19.0mm



5092-291  
Cylindrical 3.0 X 4.0mm

5020-060 Medium  
Bur Guard



BURS ARE SHOWN AT ACTUAL SIZE

5091-1XX Single Pack

5091-2XX 5/Box



5091-201  
Straight 1.0 X 5.0mm



5091-202  
Straight 1.5 X 10.0mm



5091-204  
Straight 1.5 X 7.5mm



5091-206  
Tapered 2.0 X 7.5mm



5091-212  
Linderman 1.6 X 31.0mm



5091-213  
703 Cross-Cut Fissure 1.5 X 4.9mm

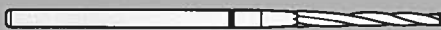

5091-214  
Straight 2.0 X 19.0mm



5091-215  
Tapered 0.8 X 4.9mm



5091-216  
Straight 1.2 X 4.9mm



5091-217  
Straight 1.6 X 4.3mm

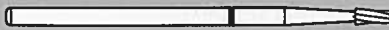

5091-218  
Tapered 1.6 X 4.3mm

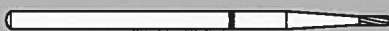

5091-219  
Straight 1.2 X 3.7mm



5091-221  
Round 1.8mm



5091-222  
Round 1.5mm



5091-223  
Round 2.3mm



5091-224  
Round 2.0mm



5091-225  
Round 2.4mm



5091-226  
Round 3.0mm

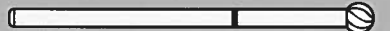

5091-228  
Round 4.0mm



5091-230  
Round 5.0mm



5091-232  
Round 6.5mm

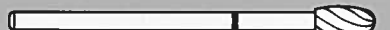

5091-236  
Oval 4.0 X 8.0mm

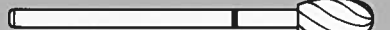

5091-238  
Oval 5.5 X 10.0mm

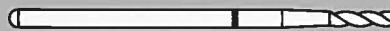

5091-242  
Swanson Reamer 2.0mm



5091-243  
Swanson Reamer 3.0mm



5091-244  
Swanson Reamer 4.0mm



5091-245  
Swanson Reamer 5.0mm

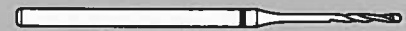

5091-247  
Wire Pass 1.0 X 19.0mm



5091-248  
Wire Pass 1.5 X 19.0mm



5091-249  
Wire Pass 2.0 X 19.0mm



5091-252  
Barrel 2.0 X 10.0mm

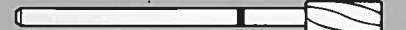

5091-254  
Barrel 4.0 X 10.0mm



5091-057  
Depth Limiting Bur 4.0 X 8.0mm



5091-058  
Depth Limiting Bur 5.5 X 10.0mm

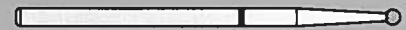

5091-260  
Round Diamond 2.0mm



5091-264  
Round Diamond 4.0mm

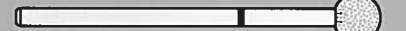

5091-268  
Round Diamond 6.0mm

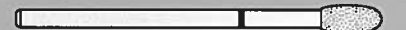

5091-270  
Oval Diamond 4.0 X 8.0mm



5091-080  
Dermabrader Diamond Straight 4.0 X 15.0mm



5091-081  
Dermabrader Diamond Straight 7.0 X 15.0mm

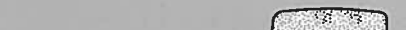

5091-082  
Dermabrader Diamond Straight 12.0 X 15.0mm

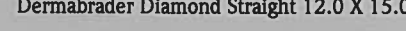

5091-083  
Dermabrader Diamond Tapered 10.0 X 15.0mm



5020-065  
70° Contra-Angle  
Attachment



5020-066  
90° Angle Attachment

5089-208  
Straight 1.5 X 8.0mm

5089-220  
Round 1.0mm

5090-201  
Straight 1.0 X 5.0mm

5090-202  
Straight 1.5 X 10.0mm

5090-203  
Straight 1.7 X 12.0mm

5090-204  
Straight 1.5 X 7.5mm

5090-206  
Tapered 2.0 X 7.5mm

5090-220  
Round 1.0mm

5090-222  
Round 1.5mm

5090-224  
Round 2.0mm

5090-247  
Wire Pass Drill 1.0 X 19.0mm

5090-248  
Wire Pass Drill 1.5 X 19.0mm

5090-249  
Wire Pass Drill 2.0 X 19.0mm

5090-291  
Cylindrical 3.0 X 4.0mm

**TAPERED FISSURE  
CARBIDE BURS**

5090-211  
Straight 1.5 X 4.5mm

5090-213  
Straight 2.1 X 5.0mm

**STAINLESS STEEL  
PILOT DRILLS**

5090-170  
1.0 X 7.0mm

5090-171  
1.0 X 10.0mm

5090-176  
1.0 X 15.0mm

5090-182  
1.0 X 20.0mm

5090-172  
1.5 X 10.0mm

5090-177  
1.5 X 15.0mm

5090-183  
1.5 X 20.0mm

5090-173  
2.0 X 10.0mm

5090-178  
2.0 X 15.0mm

5090-184  
2.0 X 20.0mm

5090-174  
2.5 X 10.0mm

5090-179  
2.5 X 15.0mm

5090-185  
2.5 X 20.0mm

BURS ARE SHOWN AT ACTUAL SIZE  
5090-1XX Single Pack  
5090-2XX 5/Box

**ORDERING  
INFORMATION**

5020-021  
5020-025  
5020-020

5020-053  
5020-054  
5020-058  
5020-059  
5020-070

*MicroChoice* Medium Speed Drill  
*MicroChoice* High Speed Drill  
*MicroChoice* Controller with 5039-003 AC  
Power Cord and 5020-056 Handpiece Cord  
*MicroChoice* Footswitch  
*MicroChoice* Controller Stand  
Handpiece Replacement Lever  
Extra-Long Handpiece Lever  
Handpiece Lever Cover

**GUARDS AND ATTACHMENTS**

5020-060  
5020-061  
5020-062  
5020-063  
5020-064  
5020-065  
5020-066  
5020-067  
5020-068  
5020-069

Medium Bur Guard  
Long Bur Guard  
Extra-Long Bur Guard  
20° Angle Attachment  
20° Angle Attachment Extra-Long  
70° Contra-Angle Attachment with Surgical Head  
90° Angle Attachment  
Laminectomy Guard  
Tissue Retractor Guard  
70° Contra-Angle Attachment with Dental Head

**IRRIGATION ACCESSORIES**

5040-039  
5040-120  
5040-129  
5040-130  
5040-200  
5040-201  
5040-202  
5040-208  
5040-219  
5040-220  
5040-222  
5040-228

Irrigation Pump  
Disposable Tubing Set  
Reusable Tubing Set  
Reusable Irrigation Handpiece Clip  
Reusable Medium Bur Tip  
Reusable External 70° and 90° Angle Tip  
Reusable Long Bur Tip  
Reusable Extra-Long Bur Tip  
Disposable Universal Irrigation Tip  
Disposable Medium Bur Tip  
Disposable Long Bur Tip  
Disposable Extra-Long Bur Tip

**OTHER ACCESSORIES**

1375-003  
1375-015  
1375-037  
5020-048  
5020-055  
5020-057  
5053-008

Bur Changer  
Bur Cleaning Brush  
Pana Spray  
*Micro E* to *MicroChoice* Controller Cord  
Irrigation System Cord  
Replacement Safe Slide  
Bur Rack

**SPECIFICATIONS**

SPECIFICATIONS	Medium Speed Drill	High Speed Drill
Operating Speed	25,000 rpm Maximum	100,000 rpm Maximum
Maximum Speed Settings	1,000 to 25,000 rpm in 2,000 rpm increments	10,000 to 100,000 rpm in 10,000 rpm increments
Torque	6 in.oz.	2 in.oz.
Bur Pull-Out Force	Exceeds 12 lbs. (5.4 Kg)	Exceeds 12 lbs. (5.4 Kg)

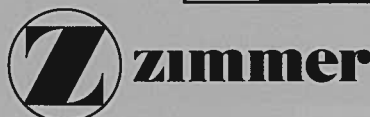

HALL SURGICAL  
11311 Concept Blvd., Largo, FL 34643  
(800) 925-4255

# THE MICROCHOICE™ RECIPROCATING SAW



Features a powerful motor for quick cutting, shaping and contouring bone. The 1/8-inch stroke, low profile design and quick stopping help minimize damage to tissue surrounding the surgical site.

BLADES ARE SHOWN AT ACTUAL SIZE  
5053-1XX Single Pack · 5053-2XX 5/Box

## FLAT BLADES



5053-122  
25.5x .25mm



5053-220  
25.5 x .4mm



5053-221  
38.0 x .4mm

## ROUND SHANK BLADES



5053-050  
5.0mm Cut Depth



5053-051  
4.0mm Cut Depth



5053-052  
5.0mm Cut Depth



5053-053  
7.0mm Cut Depth



5053-054  
Vertical Osteotomy 5.0mm



5053-126  
Non-Depth Limiting 28.0 x .6mm



## ORDERING INFORMATION

### RASPS



5053-080  
Straight Cut 5.5 x 9.5mm

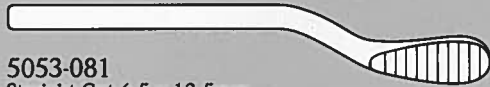

5053-081  
Straight Cut 6.5 x 12.5mm



5053-082  
Cross Cut 5.5 x 9.5mm



5053-083  
Cross Cut 6.5 x 12.5mm



5053-084  
Intramedullary 54.6 x 24.5 x 5.3mm

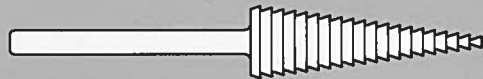

5053-085  
Intramedullary 62.2 x 30.5 x 9.5mm

5020-023	<i>MicroChoice</i> Reciprocating Saw
5020-020	<i>MicroChoice</i> Controller with 5039-003 AC Power Cord and 5020-056 Handpiece Cord
5020-053	<i>MicroChoice</i> Footswitch
5020-054	<i>MicroChoice</i> Controller Stand
5020-058	Handpiece Replacement Lever
5020-059	Extra-Long Handpiece Lever
5020-070	Handpiece Lever Cover

### IRRIGATION ACCESSORIES

5040-039	Irrigation Pump
5040-120	Disposable Tubing Set
5040-129	Reusable Tubing Set
5040-130	Reusable Irrigation Handpiece Clip
5040-207	Reusable Reciprocating Saw Tip
5040-219	Disposable Universal Irrigation Tip

### OTHER ACCESSORIES

5020-048	<i>Micro E</i> to <i>MicroChoice</i> Controller Cord
5020-055	Irrigation System Cord
5053-057	Replacement Safe Slide

## SPECIFICATIONS

Operating Speed .....	17,000 cpm
Maximum Speed Settings .....	20 -100% in increments of 10%
Stroke .....	1/10 in. (2.54mm)



HALL SURGICAL  
11311 Concept Blvd., Largo, FL 34643  
(800) 925-4255

# THE MICROCHOICE™ SAGITTAL SAW



Blades can be placed within a 180° arc providing excellent control, maneuverability and visibility for cutting transverse or wedge osteotomies.

## FLAT BLADES

BLADES ARE SHOWN AT ACTUAL SIZE  
5023-1XX Single Pack • 5023-2XX 5/Box

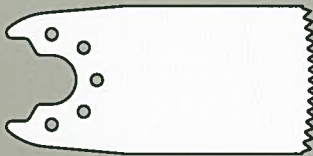

5023-230  
Coarse 19.5 x 25.5 x .4mm

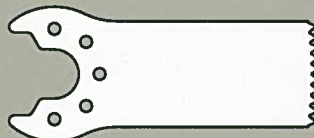

5023-237  
Coarse 14.0 x 25.5 x .4mm



5023-239  
Fine 4.5 x 25.5 x .4mm

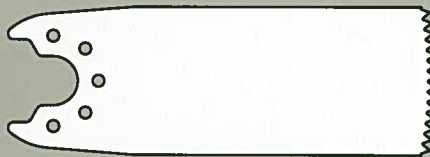

5023-231  
Coarse 19.5 x 41.0 x .4mm

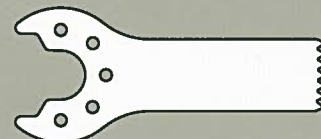

5023-243  
Coarse 9.5 x 25.5 x .4mm



5023-240  
Fine 9.5 x 41.0 x .4mm

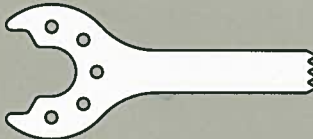

5023-232  
Coarse 5.5 x 25.5 x .4mm

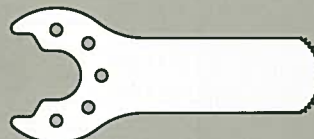

5023-218  
Fine 9.5 x 25.5 x .4mm

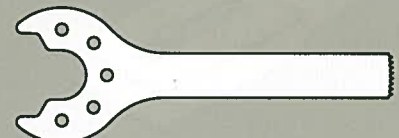

5023-241  
Fine 6.0 x 34.0 x .4mm

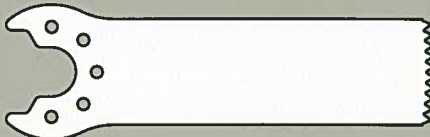

5023-233  
Coarse 14.0 x 41.0 x .4mm

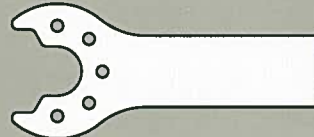

5023-238  
Fine 9.5 x 25.5 x .4mm

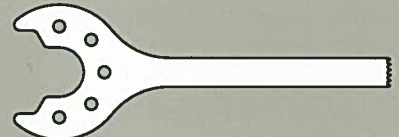

5023-242  
Fine 4.0 x 34.0 x .4mm



## ABRADERS



5023-055  
Straight Abrader 25.0 x 6.3 x 3.8mm



5023-056  
Medium Abrader  
25.0 x 6.3 x 3.8mm



5023-057  
Lateral Abrader  
25.0 x 6.3 x 3.8mm

## ANGLED BLADES

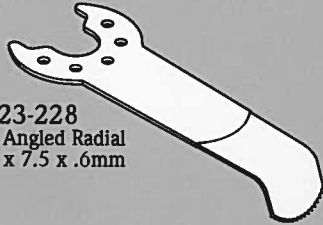

5023-228  
70° Angled Radial  
9.5 x 7.5 x .6mm

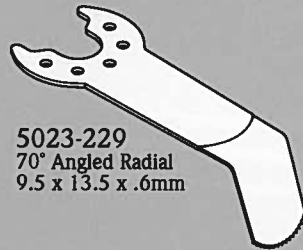

5023-229  
70° Angled Radial  
9.5 x 13.5 x .6mm

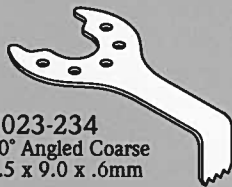

5023-234  
90° Angled Coarse  
5.5 x 9.0 x .6mm



5023-235  
45° Angled Coarse  
5.5 x 18.0 x .6mm

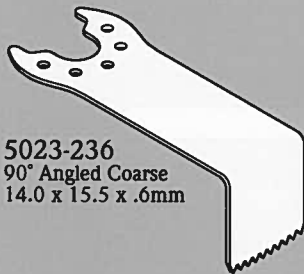

5023-236  
90° Angled Coarse  
14.0 x 15.5 x .6mm

## GRAFT HARVESTING BLADES

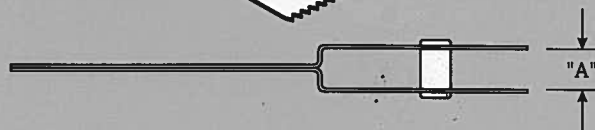
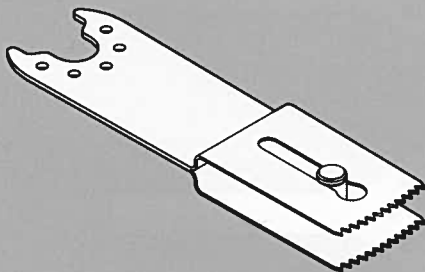

## ORDERING INFORMATION

5020-022	<i>MicroChoice</i> Sagittal Saw
5020-020	<i>MicroChoice</i> Controller with 5039-003 AC Power Cord and 5020-056 Handpiece Cord
5020-053	<i>MicroChoice</i> Footswitch
5020-054	<i>MicroChoice</i> Controller Stand
5020-058	Handpiece Replacement Lever
5020-059	Extra-Long Handpiece Lever
5020-070	Handpiece Lever Cover

## IRRIGATION ACCESSORIES

5040-039	Irrigation Pump
5040-120	Disposable Tubing Set
5040-129	Reusable Tubing Set
5040-130	Reusable Irrigation Handpiece Clip
5040-205	Reusable Sagittal Saw Tip
5040-219	Disposable Universal Irrigation Tip

## OTHER ACCESSORIES

5020-048	<i>Micro E</i> to <i>MicroChoice</i> Controller Cord
5020-055	Irrigation System Cord
5053-057	Replacement Safe Slide

## SPECIFICATIONS

Operating Speed	..... 20,000 cpm
Maximum Speed Settings	..... 20 -100% in increments of 10%
Stroke	..... 4° arc

PART NO.	DIMENSION "A"
5023-405	5mm
5023-406	6mm
5023-407	7mm
5023-408	8mm
5023-409	9mm
5023-410	10mm
5023-411	11mm
5023-412	12mm
5023-413	13mm



HALL SURGICAL  
11311 Concept Blvd., Largo, FL 34643  
(800) 925-4255

# THE MICROCHOICE™ LOW SPEED DRILL



Powerful torque and foot-operated control help assure superior results with both the Drill and Screw/Tap attachments. One handpiece satisfies all your plating needs.

BURS ARE SHOWN AT ACTUAL SIZE  
5088-1XX Single Pack · 5088-2XX 5/Box

5020-034 Dental Implant  
Drill Head



5020-035 Dental  
Implant Screw/Tap Head



## STAINLESS STEEL MICROCHOICE DRIVERS



5088-101  
For Walter Lorenz\* screws



5088-102  
For Luhr\* screws

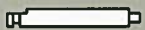

5088-103  
For Techmedica\* and Storz\* screws

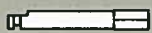

5088-104  
For Synthes\* 2.7mm screws



5088-105  
For Synthes\* 1.5 and 2.0mm screws

## TAPERED FISSURE CARBIDE BURS



5088-111  
1.6 x 4.5mm



5088-113  
2.1 x 5.0mm

## ROUND CARBIDE DENTAL BURS



5088-224  
2.1mm



5088-226  
3.1mm

## STAINLESS STEEL PILOT DRILLS



5088-170  
1.0 x 7.0mm



5088-171  
1.0 x 10.0mm



5088-176  
1.0 x 15.0mm



5088-182  
1.0 x 20.0mm



5088-172  
1.5 x 10.0mm

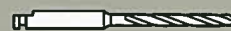

5088-177  
1.5 x 15.0mm



5088-183  
1.5 x 20.0mm



5088-173  
2.0 x 10.0mm



5088-178  
2.0 x 15.0mm



5088-184  
2.0 x 20.0mm

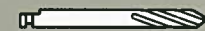

5088-174  
2.5 x 10.0mm

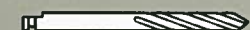

5088-179  
2.5 x 15.0mm



5088-185  
2.5 x 20.0mm

## STAINLESS STEEL WIREPASS DRILLS



5088-242  
1.0 x 15.0mm



5088-243  
1.5 x 15.0mm

\*Indicates trademarks of companies in no way affiliated with Zimmer, Inc.



## ORDERING INFORMATION

5020-026	<i>MicroChoice</i> Low Speed Drill
5020-020	<i>MicroChoice</i> Controller with 5039-003 AC Power Cord and 5020-056 Handpiece Cord
5020-034	Dental Implant Drill Head
5020-035	Dental Implant Screw/Tap Head
5020-053	<i>MicroChoice</i> Footswitch
5020-054	<i>MicroChoice</i> Controller Stand

### IRRIGATION ACCESSORIES

5040-039	Irrigation Pump
5040-120	Disposable Tubing Set
5040-128	Reusable Y Tubing Set
5040-129	Reusable Tubing Set
5040-130	Reusable Irrigation Handpiece Clip
5040-201	Reusable External 70° and 90° Angle Tip
5040-203	Reusable Internal 70° and 90° Angle Tip
5040-219	Disposable Universal Irrigation Tip

### OTHER ACCESSORIES

1375-015	Bur Cleaning Brush
1375-037	Pana Spray
5020-048	<i>Micro E</i> to <i>MicroChoice</i> Controller Cord
5020-055	Irrigation System Cord
5020-057	Replacement Safe Slide
5053-008	Bur Rack
5020-074	Dental Attachment Cleaning Ring
5020-075	Low Speed Attachment Wrench

## SPECIFICATIONS

SPECIFICATIONS	5020-034 Dental Implant Drill Head	5020-035 Dental Implant Screw/Tap Head
Operating Speed	2,500 rpm Maximum	30 rpm Maximum
Maximum Speed Settings	250 to 2,500 rpm in 250 rpm increments	2 to 30 rpm in 2 rpm increments
Torque	15 in.oz.	Screw: 25 in.oz. Tap Forward: 55 in.oz. Tap Reverse: 60 in.oz.



HALL SURGICAL  
11311 Concept Blvd., Largo, FL 34643  
(800) 925-4255

# THE MICROCHOICE™ OSCILLATING SAW



A wide selection of straight, crescentic and extended blades is available for making precise, quick osteotomies. All blades, including intra-orals, can be positioned within 360° without the use of an adaptor or wrench.

## FLAT BLADES



5023-260  
Fine 5.5 x 12.0 x .4mm

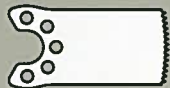

5023-261  
Fine 10.0 x 12.0 x .4mm



5023-262  
Fine 5.5 x 18.5 x .4mm



5023-263  
Fine 10.0 x 18.5 x .4mm



5023-264  
Fine 5.5 x 28.5 x .4mm



5023-265  
Fine 10.0 x 28.5 x .4mm

BLADES ARE SHOWN AT ACTUAL SIZE  
5023-1XX Single Pack · 5023-2XX 5/Box

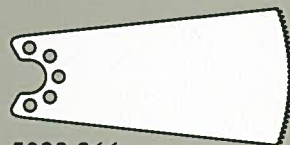

5023-266  
Fine 18.5 x 28.5 x .4mm

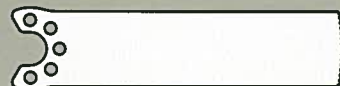

5023-269  
Fine 10.0 x 35.0 x .4mm

## 20° ANGLED BLADES



5023-258  
10.0 x 9.0 x .4mm



5023-259  
10.0 x 13.0 x .4mm



5023-267  
5.5 x 13.0 x .4mm

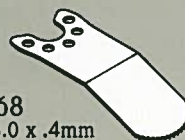

5023-268  
10.0 x 13.0 x .4mm

## CRESCENTIC BLADES



5023-170  
9.0 x 12.0 x .4mm



5023-171  
13.5 x 25.5 x .4mm



5023-172  
18.0 x 32.0 x .4mm

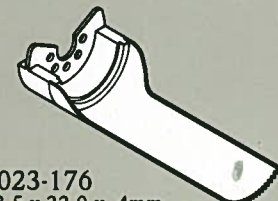

5023-176  
13.5 x 32.0 x .4mm

## ORDERING INFORMATION

### INTRA-ORAL BLADES

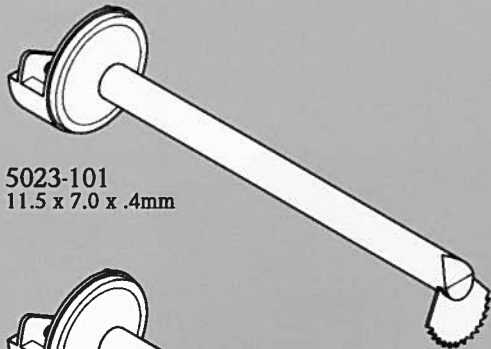

5023-101  
11.5 x 7.0 x .4mm

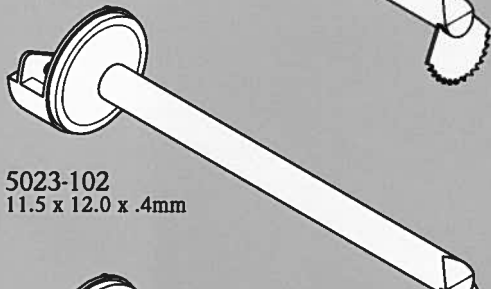

5023-102  
11.5 x 12.0 x .4mm



5023-103  
9.0 x 12.0 x .4mm

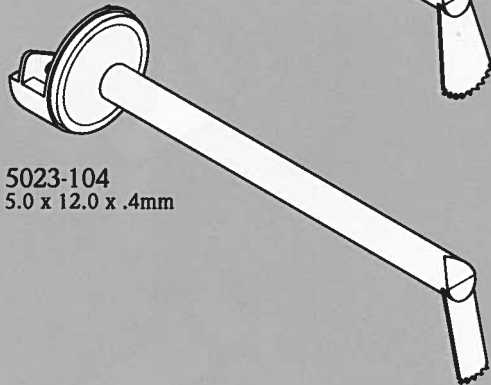

5023-104  
5.0 x 12.0 x .4mm

5020-024	<i>MicroChoice</i> Oscillating Saw
5020-020	<i>MicroChoice</i> Controller with 5039-003 AC Power Cord and 5020-056 Handpiece Cord
5020-053	<i>MicroChoice</i> Footswitch
5020-054	<i>MicroChoice</i> Controller Stand
5020-058	Handpiece Replacement Lever
5020-059	Extra-Long Handpiece Lever
5020-070	Handpiece Lever Cover

### IRRIGATION ACCESSORIES

5040-039	Irrigation Pump
5040-120	Disposable Tubing Set
5040-129	Reusable Tubing Set
5040-130	Reusable Irrigation Handpiece Clip
5040-206	Reusable Oscillating Saw Tip
5040-219	Disposable Universal Irrigation Tip

### OTHER ACCESSORIES

5020-048	<i>Micro E</i> to <i>MicroChoice</i> Controller Cord
5020-055	Irrigation System Cord
5020-057	Replacement Safe Slide

### SPECIFICATIONS

Operating Speed .....	25,000 cpm
Maximum Speed Settings .....	20 -100% in increments of 10%
Stroke .....	8° arc



HALL SURGICAL  
11311 Concept Blvd., Largo, FL 34643  
(800) 925-4255