

stryker®

Manual

EN

PNEUMO SURE HIGH FLOW INSUFFLATOR

Manual

ES

Manuel

FR

Manual

PT

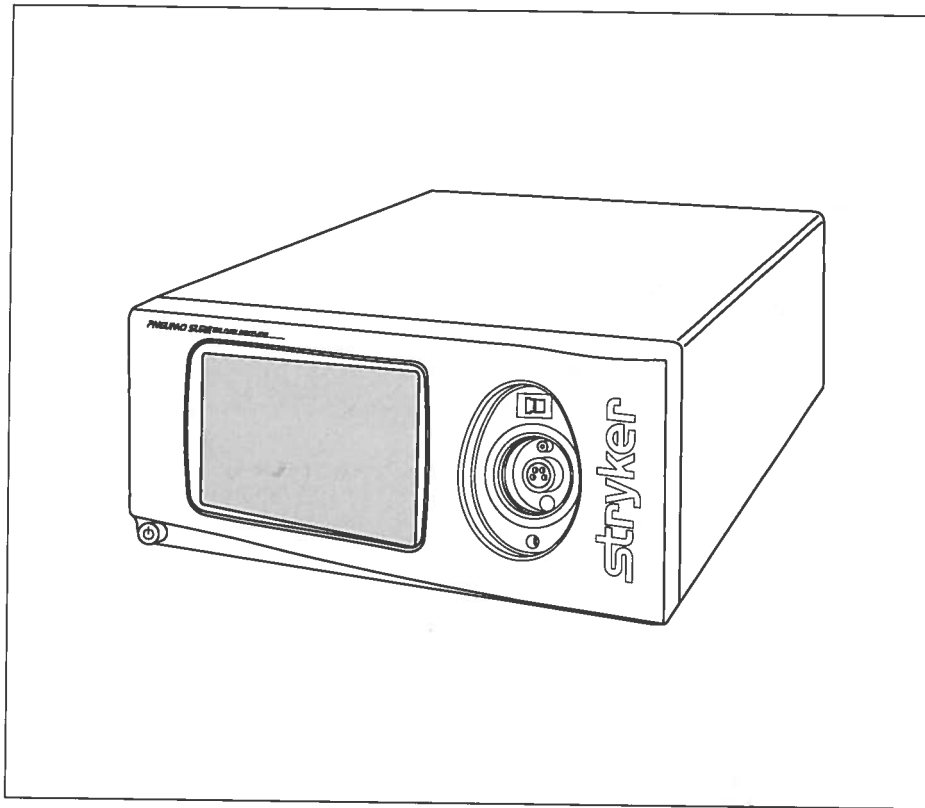

Insufflator for Laparoscopy and Vessel Harvesting

EN

This manual contains information that is subject to copyright. All rights reserved. This manual should not be photocopied, duplicated on microfilm or otherwise copied or distributed, completely or in part, without the approval of STRYKER ENDOSCOPY.

Some of the parts and equipment referred to in this manual bear registered trademarks but are not identified as such. It should therefore not be assumed that the absence of the trademark indicates that any given designation is not subject to trademark protection.

Users of this product should not hesitate to point out to us any errors or unclearities in this manual.

Copyright © STRYKER ENDOSCOPY

ES

Este manual contiene informaciones protegidas por el derecho de propiedad (copyright), que forma parte de los derechos de autor. Todos los derechos están protegidos. Sin autorización por escrito de STRYKER ENDOSCOPY, este manual no podrá ser ni total ni parcialmente reproducido ni divulgado por medio de fotocopia, microfilm u otros medios y procedimientos.

Debido al desarrollo constante de nuestros productos, nos reservamos el derecho a llevar a cabo modificaciones técnicas sin aviso previo. El funcionamiento y el diseño podrán diferir parcialmente de la descripción en el manual. Rogamos establezcan contacto con nosotros, si desean adquirir más información sobre este o cualquier otro producto.

Las denominaciones que son, a su vez, marcas registradas, no han sido identificadas especialmente. La falta de la identificación con marca no implica que el producto en cuestión no posea marca comercial alguna. Asimismo, no pueden sacarse conclusiones del presente manual, sobre la existencia o inexistencia de patentes ni modelos de utilidad.

STRYKER ENDOSCOPY agradecerá a los usuarios de los productos de STRYKER ENDOSCOPY cualquier aviso, indicación u observación con respecto a posibles fallos, incongruencias o explicaciones poco claras que puedan encontrarse en el presente manual.

Copyright © STRYKER ENDOSCOPY

FR

Ce manuel contient des informations protégées par la législation des droits de propriété et des droits d'auteur. Tous droits sont protégés. Il est interdit de reproduire ou de distribuer ce manuel - que ce soit intégralement ou partiellement par photocopie, microfilm ou autres procédés de reproduction sans l'autorisation écrite expresse de l'entreprise STRYKER ENDOSCOPY.

En raison du perfectionnement permanent de nos produits, nous nous réservons le droit de procéder à des modifications techniques sans avis préalable. Il se peut que les fonctionnalités ou que le design des produits diffèrent partiellement de la description figurant dans le manuel. Pour de plus amples informations concernant ce produit ou d'autres produits, n'hésitez pas à nous contacter.

Les désignations qui représentent en même temps des marques déposées n'ont pas été spécifiquement caractérisées. L'absence du logotype ne peut en aucun cas faire supposer que la désignation représente une marque non déposée. De la même manière, cela n'indique pas la présence de brevets ou de modèles déposés.

STRYKER ENDOSCOPY remercie d'avance les utilisateurs de ses produits qui lui fourniront des informations eu égard à des errata possibles ou à des imprécisions susceptibles d'être contenues dans ce présent manuel.

Copyright © STRYKER ENDOSCOPY

PT

Este manual contém informações que estão sob protecção do Código de Direitos do Autor. Todos os direitos estão protegidos. Sem a permissão prévia por escrito da STRYKER ENDOSCOPY não pode ser total ou parcialmente reproduzido, seja por fotocópia, microfilme ou qualquer outro procedimento, e tão-pouco distribuído.

Em função do constante desenvolvimento dos nossos produtos, reservamo-nos o direito a alterações técnicas, sem aviso prévio. A função bem como o design, podem, parcialmente, diferir da descrição apresentada no manual. É favor entrar em contacto connosco, para obter informações complementares sobre este ou outros produtos.

As designações, que também são marcas industriais, não foram identificadas especificamente. A falta da marca industrial não significa que uma designação seja uma marca industrial livre. Da mesma forma, não pode concluir-se se está ou não sob a protecção de patentes ou modelos de utilidade

A STRYKER ENDOSCOPY agradece a todos os utilizadores de seus produtos, por avisos sobre possíveis falhas ou dúvidas deste manual.

Copyright © STRYKER ENDOSCOPY

Produced for/Producido para/Produit pour/Produzido para:



Stryker Endoscopy
5900 Optical Court, San Jose
CA 95138 (USA)
(408) 754-2000 (800) 624-4422
www.stryker.com

EC REP

Stryker European Rep-
RA/QA Manager
ZAC Satolas Green Pusignan
Av. De Satolas Green
69881 MEYZIEU Cedex France

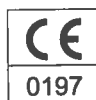

CE marking according to directive 93/42/EEC
Identificación CE conforme a la directriz 93/42/CEE
Marquage CE conforme à la directive 93/42/CEE
EDistintivo CE conforme a Directiva 93/42/CEE















Model: F114/1200628/10000002254 04/0211/ama

EN

ES

FR

PT

	Symbols	Símbolos	Symboles	Símbolos
	See operating manual	¡Atención! Observe la documentación adjunta	Attention, lire la documentation jointe!	Atenção, atentar aos documentos de expedição
	Symbol for type BF equipment	Símbolo para un aparato del tipo BF	Symbole pour un appareil de type BF	Símbolo para um aparelho do tipo BF
	Symbol for potential equalization	Símbolo para la conexión equipotencial	Fiche équipotentielle	Sistema para a compensação do potencial
IP 41	Degrees of protection provided by enclosures (IP-Code)	Grado de protección proporcionado por los envolventes (Código IP)	Degrés de protection procurés par les enveloppes (Code IP)	Classificação do grau de proteção oferecido pelas carcaças (IP)
	Alternating current	Corriente alterna	Courant alternatif	Corrente alternada
	Service	Servicio	Service	Assistência
REF	Order number	Número de pedido	Référence produit	Referência
	Single use only	No reutilizable	Usage unique	Vedada a reutilização
	Sterile with ETO	Esterilizado con ETO	Stérilisés à l'ETO	Esterilizado com ETO
	Lot no.	Denominación departida o lote	Numéro de lot	Designação do lote
SN	Serial number	Número de serie	Numéro de série	Número de série
	Date of manufacture	Fecha de fabricación	Date of fabrication	Data de fabricação
	Expiration day	Utilizable hasta	Date limite d'utilisation	Utilizável até
	Pieces, quantity	Pieza, cantidad	Pièces. quantité	Número, quantida
	Quantity	Cantidad	Quantité	Quantida
	Latex free	Sin latex	sans latex	Isento de látex
	Number of autoclaving cycles	Número de esterilizaciones por autoclave	Paramètres pour la stérilisation à l'autoclave	Número de esterilizações em autoclave









Symbols/Símbolos/Symboles/Símbolos

EN

ES

FR

PT

	Symbols	Símbolos	Symboles	Símbolos
	Do not get wet	Proteger contra la humedad	Protéger de l'humidité	Proteger da humidade
	Top-Bottom	Arriba-abajo	Haut-bas	Em cima-Em baixo
	Fragile	Frágil	Fragile	Frágil
	Waste management	Gestión de residuos	Élimination des déchets	Eliminação
	Produced for	Producido para	Produit pour	Produzido para
	Start	Start (Inicio)	Start	Start
	Stop	Stop (Parada)	Stop	Stop
	On/Off	On/Off (Encendido/ Apagado)	On/Off (Marche / Arrêt)	On/Off (Ligar/Desligar)
	Gas heater	Calentador del gas	Chauffage du gaz	Aquecedor do gás
	Gas heater error	Fallo en calentador del gas	Erreur du chauffage du gaz	Erro no aquecedor do gás
	Increase	Aumento	Croissant	Aumento
	Decrease	Disminución	Décroissant	Descida
	Forward to menu	Reemitir al menú	Expédier au menu	Enviar ao menu
	Back to menu	Volver al menú	Retour au menu	Voltar ao menu
	Stryker European Representative	Representante europeo de Stryker	Représentant Stryker Europe	Representante Europeu da Stryker
	Save	Guardar	Mémoriser	Guardar
	Exit	Salida	Sortie	Saída
	Menu - Increase	Menú-Aumento	Menu-Croissant	Menu-Aumento

	Symbols	Símbolos	Symboles	Símbolos
	Menu - Decrease	Menú-Disminución	Menu-Décroissant	Menu-Descida
	Real-Time Pressure Sensing in progress	Real-Time Pressure Sensing activada	Real-Time Pressure Sensing activée	Real-Time Pressure Sensing activada
	Real-Time Pressure Sensing defective or deactivated	Real-Time Pressure Sensing defectuosa o desactivada	Real-Time Pressure Sensing défectueuse ou désactivée	Real-Time Pressure Sensing danificada o desactivada
	House gas supply	Alimentación de gas central	Alimentation en gaz centrale	Alimentação de gás doméstico
	Tank gas supply	Alimentación por botella de gas	Alimentation en gaz par bouteille	Alimentação de gás com uma botija de gás
	Low gas pressure	Presión de gas baja	Pression de gaz basse	Pressão de gás baixa
	Gas pressure too low	Presión de gas demasiado baja	Pression de gaz insuffisante	Pressão de gás demasiado baixa
	Push to release	Presione para retirar	Appuyer pour retirer	Premir para eliminar
	Do not use if package damaged	No utilizar si el envoltorio está dañado	Ne pas utiliser si l'emballage est endommagé	Não usar se a embalagem é danificada
	Keep away from heat	Proteger contra el calor	Protéger contre la chaleur	Proteger de encontro ao calor
	Authorized for Sale or use by Physician only	Autorizado sólo para la venta o el uso médico	Autorisé seulement pour la vente ou l'utilisation par un médecin uniquement	Autorizado somente para a venda ou o uso médico

EN

ES

FR

PT



Table of contents

1	Important User Notes	3
2	Safety Information.....	4
2.1	Hazards.....	5
3	Device Purpose.....	7
3.1	Laparoscopy Applications	7
3.1.1	Using High Flow Operating Mode.....	7
3.1.2	Using Pediatric Operating Mode.....	7
3.1.3	Using Bariatric Operating Mode	8
3.1.4	Contraindications for Laparoscopy Applications.....	8
3.2	Using Vessel Harvest Operating Mode.....	8
3.3	General Device-Inherent Dangers	8
3.3.1	Device-Inherent Dangers - Laparoscopy	10
3.3.2	Device-Inherent Dangers - Vessel Harvesting.....	12
4	Initial Device Startup	14
4.1	Gas connection	14
4.1.1	Connecting a Gas Bottle.....	15
4.1.2	Connecting to Central Gas Supply.....	15
5	Operating the Device - General	16
5.1	Front of the Device.....	16
5.2	Rear of the Device	16
5.3	Touch screen display.....	17
5.4	Switch on Device	18
5.5	Connecting Insufflation Tube Set	19
5.6	Using the Gas Heating.....	20
5.6.1	Using the direct pressure measurement function (Real-Time Pressure Sensing RTP).....	21
5.6.2	Displaying/Selecting Insufflation Operating Mode	23
5.6.3	Setting the Nominal Pressure - General	23
5.6.4	Setting the Nominal Flow - General	23
5.6.5	Gas Consumption Display.....	24
5.6.6	Starting/Stopping Insufflation	24
5.6.7	Using the SIDNE Port (Optional)	25
5.6.8	Turning Device Off	25
6	Using and Controlling the PNEUMO SURE High Flow Insufflator in High Flow Mode	26
6.1	Device-Specific Dangers when Using the PNEUMO SURE High Flow Insufflator in High Flow Operating Mode.....	26
6.2	Selecting High Flow Insufflation Mode.....	28
6.3	Presetting Nominal Pressure in High Flow Operating Mode.....	28
6.4	Presetting Nominal Flow in High Flow Operating Mode	28
6.5	Performing the Function Test in High Flow Operating Mode.....	29
6.5.1	Filling Tube System with CO ₂	31
6.6	Using the Device during Surgery	31
6.6.1	Insufflating with Veress Cannula.....	31
6.6.2	Insufflating with the Trocar.....	32
6.6.3	"Real-Time Pressure Sensing" functionality (RTP)	32
6.6.4	Stop the Insufflation.....	32
7	Using and Controlling the PNEUMO SURE High Flow Insufflator in Pediatric Operating Mode	34
7.1	Device-Specific Dangers when Using the PNEUMO SURE High Flow Insufflator in Pediatric Operating Mode	34
7.2	Selecting Pediatric Operating Mode.....	36
7.3	Presetting Nominal Pressure in Pediatric Operating Mode	36
7.4	Presetting Nominal Flow in Pediatric Operating Mode	37
7.5	Performing the Function Test in Pediatric Operating Mode before Using the Device during Surgery.....	38
7.5.1	Filling Tube System with CO ₂	40
7.6	Using the Device during Surgery	40
7.6.1	Insufflating with Veress Cannula.....	40
7.6.2	Insufflating with the Trocar.....	41
7.6.3	"Real-Time Pressure Sensing" functionality (RTP)	41
7.6.4	Stop the Insufflation.....	41
8	Using and Controlling the PNEUMO SURE XL High Flow Insufflator in Bariatric Operating Mode.....	43
8.1	Device-Specific Dangers when Using the PNEUMO SURE High Flow Insufflator in Bariatric Operating Mode	43
8.2	Selecting Bariatric Operating Mode.....	45
8.3	Presetting Nominal Pressure in Bariatric Operating Mode.....	46
8.4	Presetting Nominal Flow in Bariatric Operating Mode	46
8.5	Performing the Function Test in Bariatric Operating Mode before Using the Device during Surgery	47
8.5.1	Filling Tube System with CO ₂	48
8.6	Using the Device during Surgery	49
8.6.1	Insufflating with Veress Cannula.....	49
8.6.2	Insufflating with the Trocar.....	49

8.6.3	"Real-Time Pressure Sensing" functionality (RTP)	50
8.7	Stop the Insufflation.....	50
9	Using and Controlling the PNEUMO SURE XL High Flow Insufflator in Vessel Harvest Operating Mode.....	51
9.1	Device-Specific Dangers when Using the PNEUMO SURE XL High Flow Insufflator in Vessel Harvest Operating Mode	51
9.2	Selecting Vessel Harvest Operating Mode.....	52
9.3	Presetting Nominal Pressure in Vessel Harvest Operating Mode	53
9.4	Presetting Nominal Flow in Vessel Harvest Operating Mode	54
9.5	Performing the Function Test in Vessel Harvest Operating Mode before Using the Device during Surgery.....	54
9.5.1	Filling Tube System with CO ₂	55
9.6	Using the Device during Surgery	56
9.6.1	Insufflation with Vessel Harvest Instrument	56
9.6.2	Stop the Insufflation.....	57
10	Configuration Menu (Overview).....	58
10.1	Configuration menu I.....	60
10.1.1	Setting First Nominal Pressure	60
10.1.2	Setting the Venting Controls.....	61
10.1.3	Setting the Gas Supply Type.....	62
10.1.4	Setting the Alarm Volume	63
10.2	Configuration menu II.....	64
10.2.1	Setting the Gas Flow Rates*	64
10.2.2	Setting First Nominal Gas Flow*	64
10.2.3	Setting the Maximum Nominal Pressure.....	65
10.2.4	Setting the Flow Safety Limit*	66
10.2.5	Setting the Warning signal: Occlusion	66
10.3	Utility menu	66
10.3.1	Changing Display Settings.....	67
10.3.2	Setting the Language	67
10.3.3	Checking Software Version.....	68
10.3.4	Upgrade XL*	69
10.3.5	Service Menu	69
11	Safety functions	70
12	Care and Maintenance.....	74
12.1	Cleaning the Device	74
12.2	Annual Inspection	74
12.3	Maintenance by Authorized Service Technician.....	74
12.4	Replacing the Fuse	75
12.5	Care and Maintenance of Reusable Tube Set	75
12.5.1	Cleaning the Reusable Tube Set.....	76
12.5.2	Disinfecting the Reusable Tube Set.....	76
12.5.3	Sterilization of Reusable Tube Set	76
13	Annual Inspection	78
13.1	Safety Test.....	78
13.2	Basic Function Test (in High Flow Operating Mode)	78
13.3	Testing the Pressure Sensors in High Flow Operating Mode	79
13.4	Pressure Monitoring Test in High Flow Operating Mode.....	80
13.5	Venting Valve Test	80
13.6	Max. Device Pressure Test.....	81
13.7	Gas Flow Rate Test.....	81
14	Electromagnetic compatibility	82
14.1	Impact of Mobile and Portable HF Communication Devices.....	82
14.2	Electrical Connections.....	82
14.3	Accessories	82
14.4	Guidelines and Manufacturer's Statement - Electromagnetic Interference Immunity.....	83
14.5	Guidelines and Manufacturer's Statement - Electromagnetic Emissions	84
14.6	Guidelines and Manufacturer's Statement - Electromagnetic Interference Immunity - PNEUMO SURE High Flow Insufflator	85
14.7	Recommended Safety Distances Between Portable and Mobile HF Telecommunications Devices and the PNEUMO SURE High Flow Insufflator.....	86
15	Error and Warning Messages.....	87
16	Technical Data	89
17	Accessories for PNEUMO SURE High Flow Insufflator.....	90
17.1	Accessories for Sale in USA	90
17.2	Accessories for Sale Outside of the USA	91
18	Warranty and Service	93
19	Appendix.....	95
19.1	Test Log.....	95
	Index	96

1 Important User Notes

Read the manual carefully and become familiar with the operation and function of the device and the accessories before use during surgical procedures. Non-observance of the instructions listed in this manual can lead

- to life-threatening injuries of the patient,
- to severe injuries of the surgical team, nursing staff or service personnel, or
- to damage or malfunction of device and/or accessories.

The manufacturer reserves the right to modify the appearance, graphics, and technical data of the supplied product through continued product development.

The words DANGER, WARNING, and NOTE carry special meanings. Sections marked with these words must be read especially attentively.

WARNING!

The safety and/or health of the patient, user, or a third party are at risk. Comply with this warning to avoid injury to the patient, user, or third parties.

CAUTION!

These paragraphs include information provided to the operator concerning the intended and proper use of the device or accessories.

NOTE!

Here you will read information about the maintenance of the device or the accessories.

Subject to technical changes

Please note



EN

Federal Law (only for U.S. market)**Exclusion of liability****Authorized service technician****Care and maintenance****Contamination****Waste management****2 Safety Information**

U.S. federal law restricts use of this device to use by or on the order of a physician.

The manufacturer is not liable for direct or consequential damage and the warranty is null and void if:

- the device and/or the accessories are improperly used, prepared, or maintained,
- the instructions and rules in the manual are not adhered to,
- non-authorized persons perform repairs, adjustments, or alterations on or to the device or accessories,
- non-authorized persons open the device,
- the prescribed inspection and maintenance schedules are not adhered to.

Receipt of technical documentation from the manufacturer does not authorize individuals to perform repairs, adjustments, or alterations on or to the device or accessories.

Only an authorized service technician may perform repairs, adjustments, or alterations on the device or accessories and use the service menu. Any violation will void the manufacturer's warranty. Authorized service technicians are only trained and certified by the manufacturer.

The service and maintenance of the device and its accessories has to be carried out as per instructions to ensure the safe operation of the device. For the protection of the patient and the operating team, check that the device is complete and functional before each use.

Before shipping, decontaminate device and accessories in order to protect the service personnel. Follow the instructions listed in this manual. If this is not possible,

- the product must be clearly marked with a contamination warning and
- is to be double-sealed in safety foil.

The manufacturer has the right to reject contaminated products for repair.

This symbol indicates that the waste of electrical and electronic equipment must not be disposed of as unsorted municipal waste and must be collected separately instead. Please contact the manufacturer or an accordingly authorized disposal or waste management company for further information.

2.1 Hazards

WARNING!**Condensation / Water penetration**

Protect device from moisture. Do not use if moisture has penetrated the device.

**WARNING!****Original accessories**

For your own safety and that of your patient, use only original accessories.

**WARNING!****Check all factory settings.**

Factory settings are not mandatory settings for the physician. The physician is responsible for all settings affecting the surgical procedure.

**WARNING!****Technique and procedures**

Only the physician can evaluate the clinical factors involved with each patient and determine if the use of this device is indicated. The physician must determine the specific technique and procedure that will accomplish the desired clinical effect.

**CAUTION!**

Check to make sure the available mains voltage matches the data listed on the type label attached to the back of the device. Incorrect voltage can cause errors and malfunctions and may destroy the device.

**WARNING!****Not explosion-proof**

The device is not explosion-proof. Do not use in an area where flammable anesthetic gases are present.

**WARNING!****Risk of electrical shock**

To prevent electrical shock, do not open this device. Never open this device yourself. Refer servicing to qualified service personnel.

**WARNING!****Replacing fuse**

Replace the fuse only with a fuse of the same type and rating.

**WARNING!****Professional qualification**

This manual does not include descriptions or instructions for surgical procedures/techniques. It is also not suitable for training physicians in the use of surgical techniques. Medical accessories and devices may be used only by physicians and medical assistants under the direction of a physician with the appropriate



EN

technical qualification.



WARNING!

Function test

The function test must be performed prior to each surgery.



WARNING!

Sterile mediums and accessories

Always work exclusively with sterile substances and mediums, sterile fluids, and sterile accessories if so indicated.



WARNING!

Cleaning the device

Do not sterilize the device.



WARNING!

Replacement device and accessories

In case the device or any of the accessories fail during surgery, a replacement device and replacement accessories should be kept within easy reach to be able to finish the operation with the replacement components.



WARNING!

Device-inherent dangers

Read the warnings specific to this device in chapter 3.3 General Device-Inherent Dangers.



WARNING!

Device defect

If a device defect is suspected or confirmed, do not use it. Make sure the device can no longer be used until a qualified service technician conducts the appropriate tests and repairs.



CAUTION!

Endoscope

The device may only be connected with endoscopes designed for and featuring the technical specification permitting such a combined use. Any utilized endoscopes must comply with the most recent versions of EC 60601-2-18 and ISO 8600.

3 Device Purpose

The PNEUMO SURE High Flow Insufflator serves to create a cavity by insufflating CO₂ during diagnostics and/or therapeutical laparoscopy. **High Flow operating mode**, **Pediatric operating mode**, and **Bariatric operating mode** of the device are used in conjunction with a laparoscope to fill and distend a peritoneal cavity with gas. **Pediatric operating mode** is designed specifically for use on newborns, infants, and children. **Vessel Harvest operating mode** is used to create a cavity along the saphenous vein and/or the radial artery during an endoscopic vessel harvesting procedure.

Intended use

Two alternative configurations are provided:

1. **PNEUMO SURE High Flow Insufflator** contains the applications **High Flow operating mode** -> Insufflation for adults and the **Pediatric operating mode** -> Insufflation for infants and children.
2. **PNEUMO SURE XL High Flow Insufflator** contains the applications **High Flow operating mode** -> Insufflation for adults and the **Pediatric operating mode** -> Insufflation for infants and children, **Bariatric operating mode** -> Insufflation for morbidly obese patients, **Vessel Harvest operating mode** -> Insufflation for Vessel Harvesting procedure.

The PNEUMO SURE XL configuration is available directly or via software upgrade. **High Flow operating mode**, **Pediatric operating mode**, and **Bariatric operating mode** of the device are used in conjunction with a laparoscope to fill and distend a peritoneal cavity with gas. **Bariatric operating mode** is used for laparoscopic surgery on morbidly obese patients.

Vessel Harvesting operating mode is used to create a cavity along the saphenous vein and/or the radial artery during an endoscopic vessel harvesting procedure.

3.1 Laparoscopy Applications

3.1.1 Using High Flow Operating Mode

High Flow operating mode is designed explicitly for laparoscopies performed on normal weight and slightly obese (BMI < 30 kg/m²) patients over the age of 14. While in High Flow operating mode, the insufflator limits the pressure to max. 30 mm Hg and the gas flow rate to max. 40 l/min. The device measures the pressure within the abdomen and compares the nominal with the actual abdominal pressure. The function of the device is to maintain the nominal pressure. Any over-pressure within the abdomen is lowered to the preset nominal pressure by the automatic venting system.

3.1.2 Using Pediatric Operating Mode

Pediatric operating mode is designed specifically for use on newborns, infants, and children. While in Pediatric operating mode, the insufflator limits the pressure to max. 20 mm Hg and the gas flow rate to max. 20 l/min. When used on children, the device should be set depending on the selected nominal flow and the age and weight of the treated child as outlined in the table below:

Age Group	Weight	Flow Range
Children younger than 1 year	approx. 1-9 kg	0.1 -0.5 l/min
Children between 1 and 3 years	approx. 10-15 kg	0.5 -1.0 l/min
Children between 3 and 4 years	approx. 16-19 kg	1.0 -2.0 l/min
Children between 4 and 14 years	> 20 kg	> 2.0 l/min

EN

If the nominal flow is set too low, the nominal pressure cannot be reached. Check for possible leaks. Due to the special operating method used during the Pediatric application, the speed of equalizing the leak is slower than when using the High Flow application (lower effective flow in the Pediatric application).

3.1.3 Using Bariatric Operating Mode

Bariatric operating mode is used for laparoscopies performed on severely overweight (BMI > 30 kg/m²) adults. While in Bariatric mode, the insufflator limits the pressure to max. 30 mm Hg and the gas flow to max. 45 l/min. This operating mode delivers rapid insufflation of large volumes.

3.1.4 Contraindications for Laparoscopy Applications

The device may not be used to fill an abdomen with CO₂ if a laparoscopy is contraindicated. Please consult the manual of your laparoscope for absolute and relative contraindications. The device is not suitable for hysteroscopic insufflations, i.e., it may not be used to distend the uterus.

The gas flow may not exceed 14 l/min when performing a laparoscopy on infants or patients weighing less than 25 kilos.

3.2 Using Vessel Harvest Operating Mode

WARNING!

Before using the insufflator to harvest vessels, please check whether the used instrument is intended for surgical procedures using CO₂.

Vessel Harvest operating mode is designed for the controlled insufflation of medical-grade CO₂ when harvesting vessels (veins and arteries) during a minimally invasive procedure within the scope of heart bypass surgery. While in Vessel Harvest operating mode, the insufflator limits the pressure to max. 20 mm Hg and the gas flow rate to max. 10 l/min. Surgery to harvest vessels requires the use of a special instrument.

The device may not be used for the endoscopic harvesting of vessels if this surgical application is contraindicated. Please consult the manual of the instrument for absolute and relative contraindications.

3.3 General Device-Inherent Dangers

WARNING!

Positioning the patient

Always position the patient lower than the device to prevent body fluids from leaking into the insufflation tube. Actual pressure may increase and fluid may penetrate the insufflation tube if the patient is repositioned during surgery. If this occurs, immediately disconnect the insufflation tube. When the patient is repositioned onto his or her side, internal tissue may block the insufflation channel. Always insufflate through the elevated side of the patient.

WARNING!

Removing the insufflation tube

Always disconnect the insufflation tube after ending surgery and before switching off the device to prevent backflow of bodily fluids. Fluid may penetrate the insufflation tube whenever you change the gas bottle and/or when you stop the gas flow during the operation. If this happens, you must immediately disconnect the insufflation tube from the trocar or from the device.

Contraindications



Contraindications



WARNING!

Backflow

Body secretions or contaminated gas may backflow into the device through the insufflation tube if

- a filter is not used,
- the actual pressure is higher than the nominal pressure or
- the automatic venting valve is activated.



WARNING!

Gas flow

A high gas flow can occur due to large leaks within the surgical system or instrument. This can result in a false actual pressure reading, which in turn may endanger the patient. In case of a disrupted gas flow, you should therefore inspect device, tube, and instruments immediately. Surgical applications should be carried out with a gas flow of 4-10 l/min. An even lower gas flow is recommended for diagnostic purposes. It is recommended to perform endoscopies with the lowest gas flow possible.



WARNING!

Keep filled CO2 bottle on hand

Always keep a filled CO2 bottle on hand ready for replacement. This avoids having to interrupt surgery due to a lack of insufflation gas (see chapter 4.1.1 Connecting a Gas Bottle).



WARNING!

Contamination

Do not use device and/or accessories if signs of contamination are detected. Make sure the device or/and accessories can no longer be operated until a qualified service technician conducts the appropriate tests and repairs.



WARNING!

Fatigue symptoms

When there is a high level of CO2 consumption, you should make sure to supply the operating area with enough fresh air, since an increasing CO2 level in the air can cause the medical personnel to suffer fatigue symptoms, an inability to concentrate, unconsciousness, or even death.



WARNING!

The venting rate of the automatic venting system is limited. Always monitor the actual pressure when using additional insufflation sources.



WARNING!

Contaminated filter

Replace a contaminated filter immediately during surgery to ensure unhindered gas flow.



WARNING!

Connecting the tube

Always use the proper tube set for the device. The tube outlet may only be con-



EN



nected to instruments which are intended for intra-abdominal CO₂-insufflation.

WARNING!**Electronic device control**

Do not close the valve at the trocar sleeve during surgery. The electronic control unit of the device adjusts the actual pressure as desired.

**WARNING!****Medically pure CO₂**

Make sure to use only medically pure CO₂. Other gases (i.e., helium, N₂O, argon), mixtures of gases, high pressure compressed gases, gases with entrapped liquids, or polluted gases must not be used with this device.

**WARNING!****Service connection**

Connected devices have to comply with the EN 60950 standard. Do not connect a device to the service connection during surgery.

**CAUTION!****Electrical Interference**

(See chapter 14 Electromagnetic compatibility). Electrical interference with other devices or instruments was practically eliminated when developing this device and none was detected during testing. However, if you still detect or suspect such interference, please follow these suggestions:

- Move this, the other or both devices to a different location
- Increase distance between used devices
- Consult an electro-medical expert

**WARNING!****Peripheral devices**

Additional peripheral equipment connected to interfaces of the medical monitor has to meet the requirements of the following specifications: IEC 60601-2-18 / EN 60601-2-18 for endoscopic devices and IEC 60601-1 / EN 60601-1 for electrical medical devices. All configurations have to comply with IEC 60601-1 / EN 60601-1 specifications. Whoever connects additional equipment to signal output or signal input is considered the system configurator and as such is responsible for complying with requirements of the standard IEC 60601-1 / EN 60601-1.

3.3.1 Device-Inherent Dangers - Laparoscopy

**WARNING!**

Because pediatric patients are especially susceptible to hypercapnia, it is recommended to establish an end-tidal CO₂ monitoring routine.

**WARNING!****Gas flow limit**

The gas flow may not exceed 14 l/min when performing a laparoscopy on newborns or patients weighing less than 25 kg (approx. 55 US pounds).

WARNING!**Pneumolabium/pneumosrotum**

Children are at risk of a pneumolabium or pneumosrotum.

**WARNING!****Increased airway pressure/compression of the vena cava**

When using the pediatric application of the device on children, an increased risk of high airway pressure and/or compression of the vena cava (low input syndrome) exists.

**WARNING!****Idiosyncratic reactions**

Patients with sickle cell anemia or pulmonary insufficiency may have a higher risk of metabolic imbalance related to excessive CO₂ absorption (idiosyncratic reaction).

**WARNING!****CO₂ absorption**

CO₂ is absorbed during insufflation (intravasation). This means the body absorbs part of the CO₂ gas used for insufflation. CO₂ concentrations in the blood or respiratory system that are too high can lead to death of the patient in extreme cases. To lower this risk, always carefully and closely monitor the patient's vital signs during the entire insufflation process and make sure patient is breathing well. Sufficient respiration can help avoid or limit problems with CO₂. High pressure or a high gas flow promotes CO₂ absorption. The abdomen is sufficiently distended using a pressure between 10 to 15 mm Hg. Pressure values above 15 mm Hg are required for only a few cases but do increase the risk of intravasation. Never exceed the max. intra-abdominal pressure of 30 mm Hg.

**WARNING!****Metabolic and cardiac reactions**

Insufflating CO₂ may result in metabolic acidosis. This can lead to cardiac irregularities expressed with the following symptoms:

- Reduced respiration with restricted diaphragm function
- Hypercapnia
- Reduction of venous reflux
- Reduced cardiac output
- Metabolic acidosis

**WARNING!****Hypothermia/monitoring body temperature**

The gas flow can lead to a lowering of the patient's body temperature during insufflation. Hypothermia during insufflation can cause heart and cardiovascular problems. The risk for hypothermia can be significantly reduced with the use of gas that is pre-warmed to body temperature. Always monitor the patient's body temperature during the entire insufflation. Make especially sure that the following, hypothermia promoting, surgical conditions are avoided as best as possible:

- High gas flow due to large leaks
- Long surgeries
- Use of cold (not preheated) irrigation and infusion solutions



EN

**WARNING!****Dehydration**

Insufflation can lead to dehydration of the tissue. This can result in organ tissue damage and cardiovascular reactions of the patient. Long surgeries and large leaks increase the risk of dehydration (especially at the insertion points of the trocars or when changing instruments).

**WARNING!****Embolism**

Improper placement of the insufflation instrument could cause insufflation of gas into a vessel, resulting in air or CO₂ embolisms. To reduce the risk of air or CO₂ embolism, perform initial insufflation at a low flow rate and ensure that the insufflation instrument is correctly positioned. Check the position of the insufflation instrument immediately if the actual pressure rapidly reaches the nominal pressure value. CO₂ embolisms can also be caused by a high intra-abdominal pressure. Avoid high-pressure settings and close damaged blood vessels at once.

**WARNING!****Additional insufflation sources**

The use of additional insufflation sources increases the intra-abdominal pressure. Continuously monitor intra-abdominal pressure over the course of the entire insufflation if additional sources are used.

**WARNING!****Automatic venting system**

Make sure the automatic venting system is activated (see chapter 10 Configuration Menu (Overview), page 58) when using Pediatric application and an additional insufflation source. It is not possible to use an additional insufflation source when the automatic venting system is deactivated.

**WARNING!**

Only specially trained and qualified personnel may use this device on children or for the endoscopic vessel harvesting procedure.

3.3.2 Device-Inherent Dangers - Vessel Harvesting**WARNING!**

Before using the insufflator to endoscopic harvest vessels, please check whether the used instrument is intended for CO₂ insufflation.

**WARNING!****Pneumoperitoneum**

When a vessel is harvested from the leg of a patient with a perforated groin, it is possible for CO₂ to reach the abdomen and cause a pneumoperitoneum. Make sure the abdomen does not fill with CO₂ during surgery.

**WARNING!****Idiosyncratic reactions**

Patients with sickle cell anemia or pulmonary insufficiency may have a higher risk of metabolic imbalance related to excessive CO₂ absorption (idiosyncratic

reaction).

WARNING!**CO₂ absorption**

Due to the special surgical procedures - start of the heart bypass operation, and the endoscopic removal of the vessel - special care has to be taken as CO₂ is always absorbed through the tissue of the patient during insufflation (intravasation). This means the body absorbs part of the CO₂ gas used for insufflation. CO₂ concentrations in the blood or respiratory system that are too high can lead to death of the patient in extreme cases. To lower this risk, always carefully and closely monitor the patient's vital signs during the entire insufflation process and make sure patient is breathing well. Sufficient respiration can help avoid or limit problems with CO₂. High pressure or a high gas flow promotes CO₂ absorption.

**WARNING!****Metabolic and cardiac reactions**

Due to the special surgical conditions - start of the heart bypass surgery and vessel harvesting - it is especially important to remember the existing risk of metabolic acidosis when insufflating with CO₂. This can lead to cardiac irregularities expressed with the following symptoms:

- Reduced respiration with restricted diaphragm function
 - Hypercapnia
 - Reduction of venous reflux
 - Reduced cardiac output
 - Metabolic acidosis
-

**WARNING!****Dehydration**

Insufflation can lead to dehydration of the tissue. This can result in organ tissue damage and cardiovascular reactions of the patient. Long surgeries and large leaks increase the risk of dehydration (especially at the insertion points of the trocars or when changing instruments).

**WARNING!****Embolism**

Improper placement of the insufflation instrument could cause insufflation of gas into a vessel, resulting in air or CO₂ embolisms. To reduce the risk of air or CO₂ embolism, perform initial insufflation at a low flow rate and ensure that the insufflation instrument is correctly positioned. Check the position of the insufflation instrument immediately if the actual pressure rapidly reaches the nominal pressure value. CO₂ embolisms can also be caused by a high pressure. Avoid high-pressure settings and close damaged blood vessels at once.

**WARNING!**

Only specially trained and qualified personnel may use this device on children or for the endoscopic vessel harvesting procedure.



EN

Delivery inspection**Setting up the device****Mains connection****Grounding contact****Only for U.S. operators****Potential equalization****4 Initial Device Startup**

Always check all parts and accessories of the device immediately after receiving the shipment. The manufacturer considers only replacement claims that have been immediately submitted or reported to a sales representative or an authorized service company.

Place the device on a level surface and install in a dry environment. The ambient temperature and humidity must meet the requirements mentioned in chapter 16 Technical Data, page 89.

WARNING!**Not explosion-proof**

The device is not explosion-proof. Do not use in an area where flammable anesthetic gases are present.

CAUTION!

Check to make sure the available mains voltage matches the data listed on the type label attached to the back of the device. Incorrect voltage can cause errors and malfunctions and may destroy the device.

Make sure the connection data and technical specifications of the power supply comply with DIN VDE or national requirements. The mains power supply cable must be plugged into a properly installed safety wall plug (see DIN VDE 0107). Read the device label located in rear of device (type plate) to determine the operating voltage of the device.

The power connection must be equipped with a grounding contact. Use the original power cable (if included in scope of delivery) to establish a connection between the mains wall socket and the non-heating device plug located in the rear of the device.

Only use a certified (UL-listed), removable mains connection line, type SJT, minimal 18 AWG, 3 leads. The plug connectors must comply with NEMA 5-15 or IEC 320/CEE22. Grounding will only be reliable if the equipment is connected to a corresponding hospital grade socket.

Integrate the device into the potential equalization system as specified by local safety rules and regulations.

4.1 Gas connection**WARNING!****Medically pure CO₂**

Make sure to use only medically pure CO₂. Other gases (i.e., helium, N₂O, argon), mixtures of gases, high pressure compressed gases, gases with entrapped liquids, or polluted gases must not be used with this device.

Use a high-pressure tube to connect a CO₂ gas cylinder to the rear gas inlet connection or connect to centralized CO₂ gas supply.

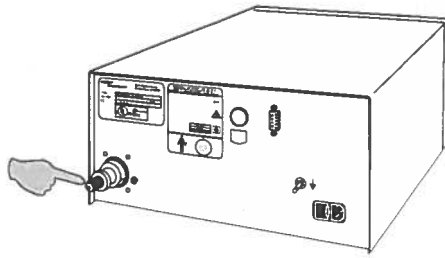

4.1.1 Connecting a Gas Bottle

CAUTION!

Always use a high-pressure tube to connect gas bottle and device.



The gas bottle must be in a vertical position. The gas bottle pressure may not exceed 80 bar or be less than 15 bar.

CAUTION!

Gas bottles with riser pipe can release dirt and oily fluids into the device. Do not use a gas bottles with riser pipe.



4.1.2 Connecting to Central Gas Supply

Use the following device connectors available as additional equipment to connect to a central gas supply (house supply):

- 0620-040-003 for NIST house gas supply or
- 0620-040-002 for DISS house gas supply.

1. Attach the high-pressure tube to the gas connection.
2. Fix the high-pressure tube with the nut.
3. Tighten the nut.

The type of corresponding gas supply must be set in the configuration menu (see chapter 10.1.3 Setting the Gas Supply Type, page 62).

EN

5 Operating the Device - General

5.1 Front of the Device

Fig. 5-1 Device Front

- ① ON/OFF switch
- ② Touch screen display
- ③ Insufflation tube connection

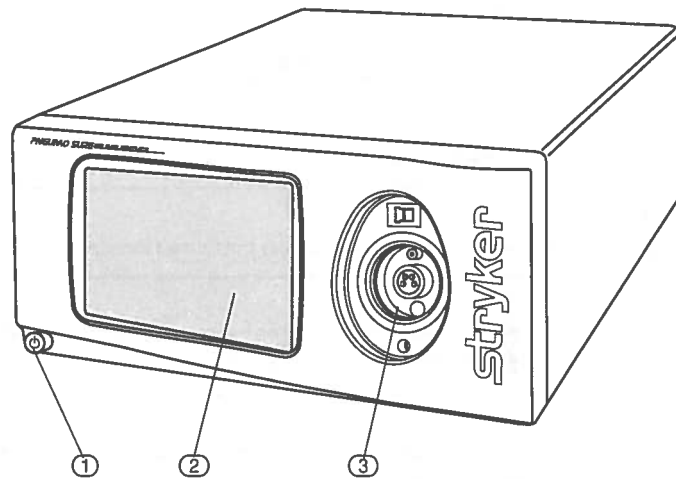

Familiarize yourself with the control and function elements at the front of the device.

5.2 Rear of the Device

Fig. 5-2 Device Rear

- ④ Type plate
- ⑤ Device data plate
- ⑥ SIDNE interface (optional)
- ⑦ Data input/output
- ⑧ Connection for potential equalization
- ⑨ Device plug
- ⑩ Fuse holder
- ⑪ Gas supply connection

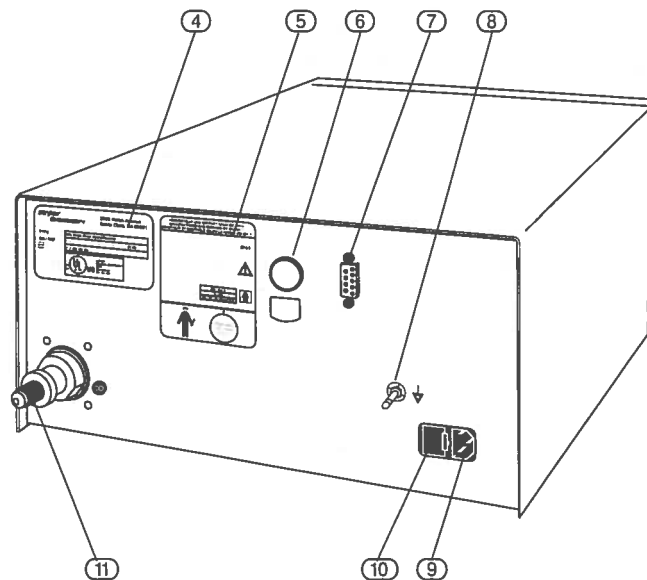

Familiarize yourself with the connection elements at the rear of the device.

5.3 Touch screen display

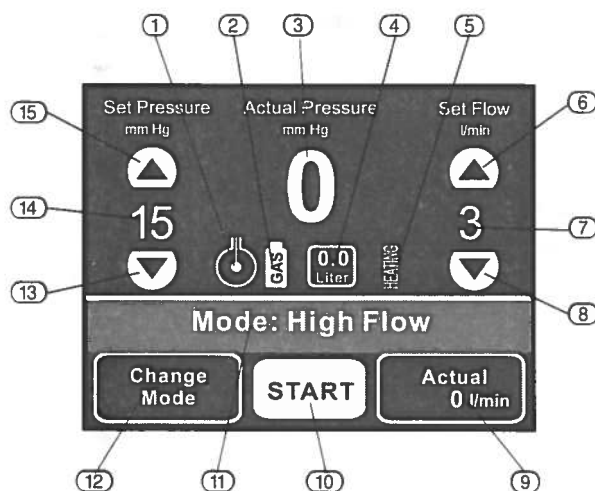

Fig. 5-3 Screen displays

- ① Continuous pressure reading display
- ② Gas supply display
- ③ Actual pressure display
- ④ Gas consumption display/function field for reset
- ⑤ Gas heating connected/ready
- ⑥ Increasing nominal gas flow
- ⑦ Nominal gas flow display
- ⑧ Decreasing nominal gas flow
- ⑨ Actual gas flow display/ menu function field
- ⑩ START/STOP function field
- ⑪ Status display/error and warning messages
- ⑫ Insufflation operating mode display/selecting insufflation operating mode
- ⑬ Decreasing nominal pressure
- ⑭ Nominal pressure display
- ⑮ Increasing nominal pressure

The above depiction of the touch screen also shows all display and function fields. Field ⑨ serves as actual flow display (depicted without frame while insufflating) and also as menu function field (depicted with frame).

Field ⑫ serves as insufflation operating mode display (depicted without frame while insufflating) and also as control field for selecting the insufflation operating mode (depicted with frame).

Press the function field ⑨ or ⑫ depicted with frame and hold for 2 seconds to trigger functions or set values. Additional explanations for individual elements are presented in the subsequent respective control element descriptions.

The status of the gas supply is monitored by the device and indicated with symbols and acoustic signals (see chapter 11 Safety functions for gas pressure display information).

The following gas bottle pressures are displayed:

	> 50 bar
	40 - 50 bar
	30 - 40 bar
	15 - 30 bar; Three warning signals can be heard and the message "Change gas tank" is displayed. User is advised to obtain a replacement tank.
	< 15 bar; Three warning signals can be heard and the message "Check gas supply" is displayed. Replace gas tank immediately.

If gas supply pressure declines further, there are warnings to remind the user to replace the gas tank immediately. Five warning signals can be heard and the message "Check gas supply" is displayed at < 5 bar and again at 0 bar. Insufflation stops at 0 bar.

Gas supply displays

Gas supply with gas bottle

EN

House gas supply

The following house gas supply pressures are displayed:



House gas supply pressure OK



House gas supply pressure too low

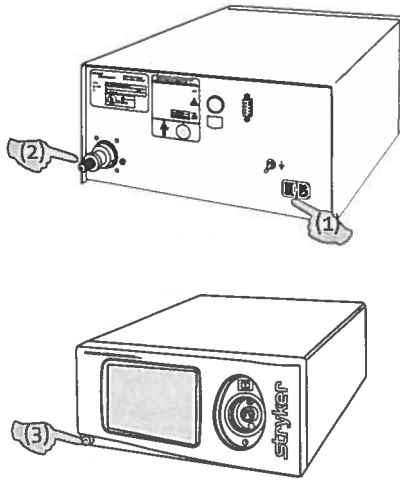

5.4 Switch on Device

1. Connect with mains power supply.
2. Connect the gas supply to the gas connection port and open the gas supply.

3. Press the ON/OFF switch. The device switches on.

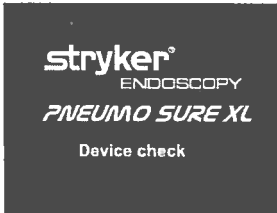

4. After being switched on, the device performs a device check. The touch screen depicts the **company logo** as well as the lines **PNEUMO SURE** respectively **PNEUMO SURE XL ->Device check ->Device OK** is visible for 3 seconds after the successful completion of the device check. In case the device check failed and error message is displayed please see chapter 15 Error and Warning Messages for advises.

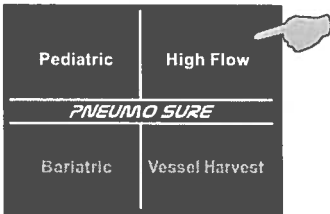

5. The display depicts an insufflation operating modes overview. Unavailable operating modes are depicted in gray and cannot be selected. Press the respective function field to select the corresponding desired operating mode (e.g. **High Flow**).

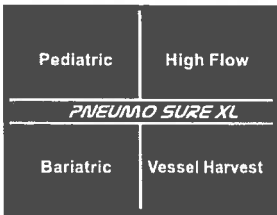

5.5 Connecting Insufflation Tube Set

Three different insufflation tube set types can be connected to the insufflation tube connection at the front of the device (see Fig. 5-1 Device Front, page 16, ③).

Heated tube set with Real-Time Pressure Sensing (RTP)

- Disposable (single use) insufflation tube set with:
- Filter
 - Gas heating
 - Measuring tube for direct pressure measurement (RTP)

High Flow tube set with Real-Time Pressure Sensing (RTP)

- Disposable (single use) insufflation tube set with:
- Filter
 - Measuring tube for direct pressure measurement (RTP)

High Flow II tube set

- Disposable (single use) insufflation tube set with:
- Filter

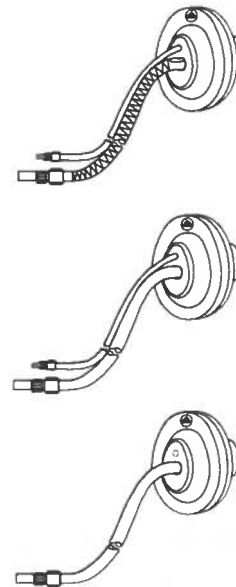

Insert the plug of the insufflation tube set correctly into the insufflation tube set connection at the front of the device until it snaps firmly into place.

Connecting the tube set

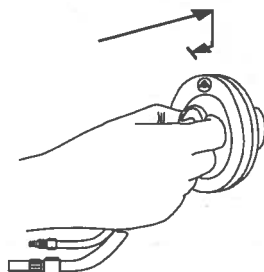

- A short acoustic warning signal is emitted,
- the message **Tube set connected** is displayed,
- a check mark is displayed.

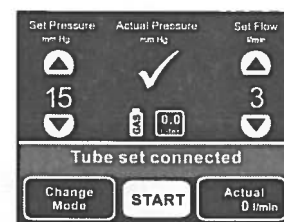

If the tube is accidentally unlatched by pressing twice or if the tube is removed during insufflation:

- 2 long acoustic warning signal are emitted,
- the message **Tube set not connected** is displayed,

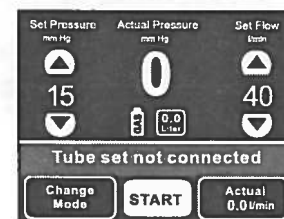

EN

Removing the tube set

Press the plug of the insufflation tube in the direction of the device. This releases the snap-in latch and you are now able to remove the insufflation tube set.

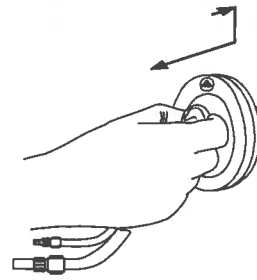

- 2 long acoustic warning signal are emitted,
- the message **Tube set not connected** is displayed,

Connecting the gas heating

5.6 Using the Gas Heating

Use the heating tube to insufflate lukewarm gas (37° C).

1. Switch device on.
2. Connect an insufflation tube with gas heating (Heated tube set with Real-Time Pressure Sensing (RTP)).

The heating module is located directly in the insufflation tube.

Fig. 5-4 Connecting the gas heating

- ① Plug for insufflation tube with gas heating
- ② Internal heating
- ③ Insufflation tube
- ④ Measuring tube

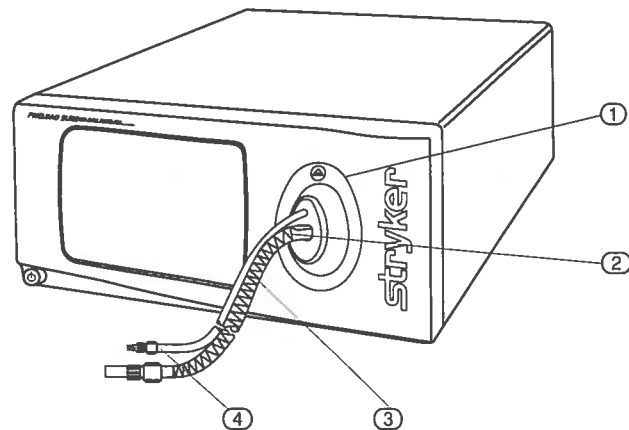

CAUTION!

Do not subject the heater tube to direct heat (e.g., operating room lamp, endoscop with light source) or high room temperatures.

Gas heating display

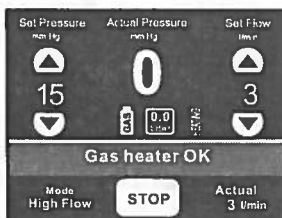

The device automatically determines whether a tube set with or without gas heating is connected. The display depicts a symbol  and the status line reads **Gas heater OK** after the successful detection of the corresponding tube set.

1. **The gas heating is automatically started at the START of the insufflation:**
Press the **START** function field. The gas is automatically heated to 37 °C.
2. **Stopping gas heating:**
Press the **STOP** function field. Gas heating is switched off.
3. Pull the tube set plug from the device connection.

When a defective heating tube set is used,

- the display depicts a crossed out symbol 
- the text line reads **Gas heater defective <-> Call service,**
- and an acoustic signal is emitted (3 short beeps).

Insufflation can be continued in this case, but the heating function is not available.

The device is equipped with a temperature sensor to protect against overheating, caused for example by external heat sources. If the temperature sensor measures a temperature >42°C, the status field of the display depicts **Gas temperature >42 °C**; 3 acoustic signals are emitted in addition, the **HEATING** symbol is crossed out . Insufflation and the heating function are halted. After 3 seconds, the display depicts **Disconnect luer lock** alternating with **Cool down tube** until the insufflation is manually restarted.

WARNING!

Unplug the cable of the heating tube from the device if the temperature sensor measures a gas temperature exceeding >42 °C. Hot gas in the abdomen can lead to serious injuries.

1. Disconnect the insufflation tube from the trocar or Veress needle.
2. Press the **START** function field. The device insufflates without heating the gas.
3. Let hot gas escape until the tube is only warm to the touch and then reconnect the device again.
4. Continue surgery without gas heating.

1. Check gas heating after surgery using a different tube. Turn the device off and back on after approx. 10 seconds have expired. Gas heating is reactivated.
2. Should the error message be displayed again, you can continue using the device without gas heating by observing the risks for hypothermia.
3. Call an authorized service technician to check/fix the gas heating.

5.6.1 Using the direct pressure measurement function (Real-Time Pressure Sensing RTP)

The insufflation tube sets "Heated tube set with Real-Time Pressure Sensing (RTP)" and "High Flow tube set with Real-Time Pressure Sensing (RTP)" are equipped with a sensor line which enables continuous measuring of the abdominal pressure. The insufflation line must be connected to one trocar and the measuring line (sensor line) to a second trocar. This set-up enables the PNEUMO SURE XL High Flow Insufflator to directly measure the actual abdominal pressure while in **High Flow-, Pediatric- and Bariatric** operating mode. The "Real-Time Pressure Sensing" is deactivated during the **Vessel Harvest** operating mode. The use of an insufflation tube without a second measurement/sensor line only allows the intermittent measuring of the pressure.

Insufflation is initially always started intermittently. Availability of the "Real-

Gas heating ON/OFF



Incorrect/defective heating tube



Gas temperature exceeds 42 °C

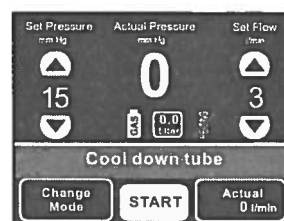

Check gas heating after surgery

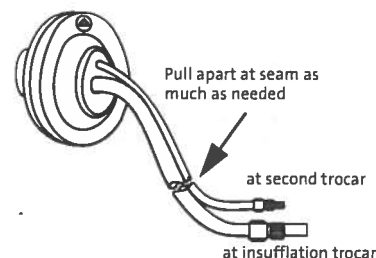

EN

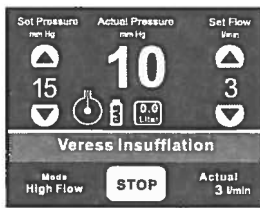

Error detection and monitoring of the "Real-Time Pressure Sensing (RTP)" function

"Real-Time Pressure Sensing" functionality is checked automatically. If this is the case, the device switches to a continuous mode. This is indicated by the corresponding symbol on the display: 

The  symbol is removed if continuous pressure measurement is currently not possible or if insufflation is stopped.

CAUTION!

A closed, obstructed or disconnected pressure sensing line will disable the real-time pressure sensing function. In this case the device will operate in the conventional intermittent insufflation mode.

The continuous pressure measurement function is verified during the initial device self check. Should a defect within the measuring system be detected, three acoustic warning signals are emitted. The symbol  is crossed out and the status line reads as follows: **RTP defective / Call Service.**

A detected defect within continuous pressure measurement does not generally hinder use of the device, however without the RTP function. Disconnect the measuring channel and perform the surgery in the intermittent insufflation mode. The acoustic warning on the defective RTP will be emitted with every activation/deactivation of the insufflation as long as the pressure measurement function remains defective.

CAUTION!

Do not attach a trocar to the pressure measurement / sensor line if the message "RTP defective / Call Service" is displayed. Perform surgery only in the conventional intermittent insufflation mode without using the real-time pressure sensing function.



In case of a closed sensor line or with pressure on the sensor or the insufflation line during the initial device self check the real-time pressure sensing function will not be activated and the  will be crossed out. Three acoustic warning signals are emitted, the status line reads as follows: **RTP deactivated.** The device can be operated in the conventional intermittent insufflation mode. In order to activate the RTP function the sensor line must be cleared, possible pressure released and the device rebooted by turning it off and back on.

CAUTION!

When working with a tube set permitting the use of the RTP function, please make sure that both lines are open upon activation of the device and there is pressure neither on the sensor line nor on the insufflation line. Otherwise the real-time pressure sensing function (RTP) will not be recognized and activated during the initial device self check.



In case of an occlusion or a leakage in the sensor line during insufflation the device will automatically switch from the RTP operating mode into the conventional intermittent insufflation mode.

Leakage detection with function "Real-Time Pressure Sensing (RTP)"

If the system detects a leak at the RTP connection regardless of the insufflation mode:

- 2 long acoustic warning signal are emitted,
- the RTP symbol is no longer depicted,
- the message **Check/change tube set** is displayed,
- the usual intermittent pressure measuring is enabled again,
- the function of the occlusion detection is disabled.

5.6.2 Displaying/Selecting Insufflation Operating Mode

The device can be equipped with up to 4 procedure modes. Procedure options can be released or uploaded in different combinations depending on the order or software upgrade.

PNEUMO SURE	High Flow operating mode / Pediatric operating mode
PNEUMO SURE XL	High Flow operating mode / Pediatric operating mode / Bariatric operating mode / Vessel Harvest operating mode

- Control or selection of the insufflation modes can be done only while insufflation is stopped. Press the function field for 2 s to change the insufflation operating mode.
- The display depicts an insufflation operating modes overview. Unavailable operating modes are depicted in gray and cannot be selected. Press the respective function field to select the corresponding desired operating mode (e.g. Pediatric).
- After pressing the function field for the insufflation operating mode, the display depicts the selected procedure (e.g. Pediatric operating mode). The displayed parameters correspond with the factory settings or the values set in the Configuration menu (see chapter 10.1 Configuration menu I, page 60).

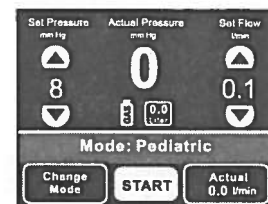
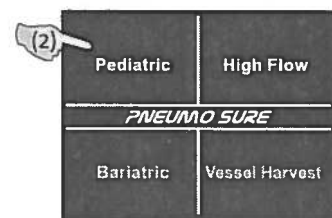
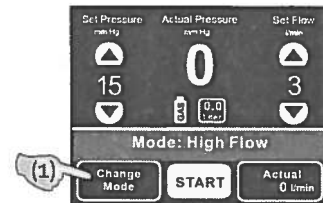

5.6.3 Setting the Nominal Pressure - General

Press the function fields ▲ or ▼ on the display below the text line **Set Pressure** to set the nominal pressure.

Applies to all modes:

- The nominal pressure can be increased or decreased during insufflation or while insufflation is stopped.
- With every touch of the pressure function field ▲ or ▼ the nominal pressure is increased/reduced in steps of 1 mm Hg. When pressing the pressure function field ▲ or ▼ longer than 1,5 seconds, scrolling is activated but only up to the respective, application-dependent safety threshold. Once this limit has been reached, the status line depicts the message **Safety limit** and the actual value flashes. To allow settings above the safety threshold release the pressure function field for 2 seconds. The display switches back to the status display. Now it is possible to increase the pressure above the safety threshold but only to the next safety threshold (as far as existent) or to the maximum setting.
- The latest working settings are stored with interruption of the insufflation, but only if the last value was below the lowest safety threshold (**15 mm Hg for High Flow and Bariatric operating mode, 12 mm Hg with Pediatric operating mode and Vessel Harvest operating mode**). Otherwise the set pressure value is reset to the lowest safety threshold upon deactivation of insufflation.
- The latest settings are reset to the values preselected in the **Configuration menu** when deactivating the device or when changing into the **Configuration menu** or the Mode Selection menu. Upon choice of the respective working mode the nominal settings as stored in the Configuration menu are displayed (see chapter 10.1 Configuration menu I, page 60).

5.6.4 Setting the Nominal Flow - General

Press the function fields ▲ or ▼ on the display below the text line **Set Flow** to set the nominal flow.

Applies to all modes:

EN

- The nominal flow can be increased or decreased during insufflation or while insufflation is stopped.
- With every touch of the flow function field ▲ or ▼ the nominal flow is increased/reduced in steps of 1 l/min. When working within the range of 0.1 to 1 l/min in Pediatric mode, the value is increased/reduced 0.1 l/min. When pressing the flow function field ▲ or ▼ longer than 1.5 seconds, scrolling is activated but only up to the respective, application-dependent safety threshold. Once this limit has been reached, the status line depicts the message **Safety limit** and the actual value flashes. To allow settings above the safety threshold release the function field for 2 seconds. The display switches back to the status display. Now it is possible to increase the flow above the safety threshold but only to the next safety threshold (as far as existent) or to the maximum setting.
- The latest working settings are stored with interruption of the insufflation, but only if the last value was below the lowest safety threshold (**5 l/min** for **Pediatric** operating mode and **6 l/min** for **Vessel Harvest** operating mode). Otherwise the set flow value is reset to the lowest safety threshold upon deactivation of insufflation.
- The latest settings are reset to the values preselected in the **Configuration menu** when deactivating the device or when changing into the Configuration menu or the **Mode Selection menu**. Upon choice of the respective working mode the nominal settings as stored in the **Configuration menu** are displayed (see chapter 10 Configuration Menu (Overview), page 58).
- The flow safety thresholds can be deactivated in the **Configuration menu**.

5.6.5 Gas Consumption Display

The gas consumption display depicts the insufflated volume of the gas in liters since the last "resetting" of the display. The display indicates values between 0.0 liter and 9.9 liter in increments of 0.1 and between 10 liter to 999 liter in increments of 1.

The gas consumption display can be reset to **0.0** while insufflation is started as well as stopped. Press the gas consumption display/function field to reset the gas consumption display.

Resetting the display

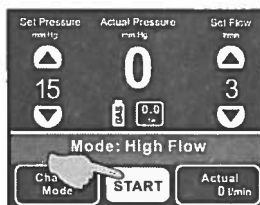
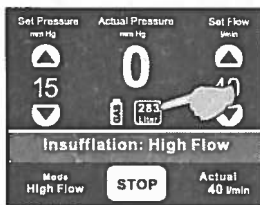

5.6.6 Starting/Stopping Insufflation

The **START** or **STOP** function field is displayed differently depending on operating status.

Start insufflation:

The **START** function field is displayed while insufflation is stopped. Press this field to start insufflation.

The status display depicts the selected insufflation mode (e.g. **Mode: High Flow**). The insufflation mode display depicts **Change Mode**.

Start insufflation by pressing the **START** function field.

Activated insufflation:

The status line depicts **Insufflation** and the name of the selected insufflation mode (e.g. **Insufflation: High Flow** or **Veress insufflation**).

The frames around the insufflation mode display and the actual gas flow (menu access) are hidden. This signals that these function fields are inactive during this state.

The insufflation mode display depicts the selected mode (e. g. **Mode: High Flow**).

Stop insufflation:

The **STOP** function field is displayed while insufflation is active.

Stop insufflation by pressing the **STOP** function field.

The status line depicts **Insufflation stopped** followed by the selected mode (e.g. **Insufflation: High Flow**) alternating with **Push to release**. The insufflation mode display depicts **Change Mode**.

In case the tube set connection is lost, the insufflation stops and the display depicts **Insufflation stopped ->Mode: High Flow <->Tube not connected**.

The device depicts the same message if a tube set has not been connected or has not been inserted correctly and the **START** function field has been pressed. In this case the insufflation will not be started. Please insert a tube set or check the tube set connection.

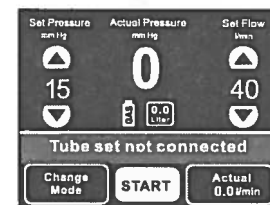
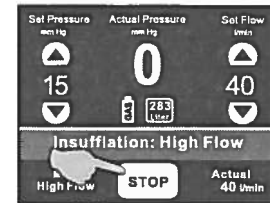
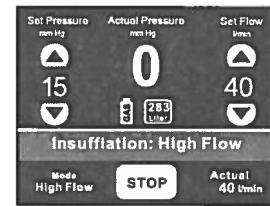

5.6.7 Using the SIDNE Port (Optional)

The SIDNE Port allows connection to the SIDNE control system. When connected, all of the functions and settings of the insufflator can be:

- controlled with SIDNE voice and pendant commands; and
- displayed on the SIDNE video overlay and pendant.

The physician(s) and support personnel must be thoroughly familiar with the set-up and operation of the SIDNE. Please refer to the SIDNE documentation for the proper setup, use and troubleshooting. When SIDNE is connected and active, the functions and settings of the insufflator may simultaneously be adjusted using the buttons on the front panel and the SIDNE.

5.6.8 Turning Device Off

Use the ON/OFF switch to turn the device off. The device is turned off.

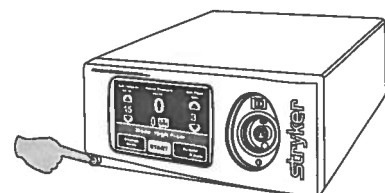

EN

Intended use**Contraindications****6 Using and Controlling the PNEUMO SURE High Flow Insufflator in High Flow Mode**

The PNEUMO SURE High Flow Insufflator serves to create a cavity by insufflating CO₂ during diagnostics and/or therapeutic laparoscopy. High Flow operating mode is designed explicitly for laparoscopies performed on normal weight and slightly obese (BMI < 30 kg/m²) patients over the age of 14. While in High Flow operating mode, the insufflator limits the pressure to max. 30 mm Hg and the gas flow rate to max. 40 l/min. The device measures the pressure within the abdomen either continuously or at short intervals and constantly compares the nominal with the actual abdominal pressure. The function of the device is to maintain the nominal pressure. Any overpressure within the abdomen is lowered to the preset nominal pressure by the automatic venting system.

The device may not be used to fill an abdomen with CO₂ if a laparoscopy is contraindicated. Please consult the manual of your laparoscope for absolute and relative contraindications. The device is not suitable for hysteroscopic insufflations, i.e., it may not be used to distend the uterus.

The gas flow may not exceed 14 l/min when performing a laparoscopy on infants or patients weighing less than 25 kilos.

6.1 Device-Specific Dangers when Using the PNEUMO SURE High Flow Insufflator in High Flow Operating Mode**WARNING!****Idiosyncratic reactions**

Patients with sickle cell anemia or pulmonary insufficiency may have a higher risk of metabolic imbalance related to excessive CO₂ absorption (idiosyncratic reaction).

**WARNING!****CO₂ absorption**

CO₂ is absorbed during insufflation (intravasation). This means the body absorbs part of the CO₂ gas used for insufflation. CO₂ concentrations in the blood or respiratory system that are too high can lead to death of the patient in extreme cases. To lower this risk, always carefully and closely monitor the patient's vital signs during the entire insufflation process and make sure patient is breathing well. Sufficient respiration can help avoid or limit problems with CO₂. High pressure or a high gas flow promotes CO₂ absorption. The abdomen is sufficiently distended using a pressure between 10 to 15 mm Hg. Pressure values above 15 mm Hg are required for only a few cases but do increase the risk of intravasation. Never exceed the max. intra-abdominal pressure of 30 mm Hg.

**WARNING!****Metabolic and cardiac reactions**

Insufflating CO₂ may result in metabolic acidosis. This can lead to cardiac irregularities expressed with the following symptoms:

- Reduced respiration with restricted diaphragm function
- Hypercapnia
- Reduction of venous reflux
- Reduced cardiac output
- Metabolic acidosis

**WARNING!****Hypothermia/monitoring body temperature**

The gas flow can lead to a lowering of the patient's body temperature during insufflation. Hypothermia during insufflation can cause heart and cardiovascular



problems. The risk for hypothermia can be significantly reduced with the use of gas that is pre-warmed to body temperature. Always monitor the patient's body temperature during the entire insufflation. Make especially sure that the following, hypothermia promoting, surgical conditions are avoided as best as possible:

- High gas flow due to large leaks
- Long surgeries
- Use of cold (not preheated) irrigation and infusion solutions

WARNING!**Dehydration**

Insufflation can lead to dehydration of the tissue. This can result in organ tissue damage and cardiovascular reactions of the patient. Long surgeries and large leaks increase the risk of dehydration (especially at the insertion points of the trocars or when changing instruments).



WARNING!**Embolism**

Improper placement of the insufflation instrument could cause insufflation of gas into a vessel, resulting in air or CO₂ embolisms. To reduce the risk of air or CO₂ embolism, perform initial insufflation at a low flow rate and ensure that the insufflation instrument is correctly positioned. Check the position of the insufflation instrument immediately if the actual pressure rapidly reaches the nominal pressure value. CO₂ embolisms can also be caused by a high intra-abdominal pressure. Avoid high-pressure settings and close damaged blood vessels at once.



WARNING!**Additional insufflation sources**

The use of additional insufflation sources increases the intra-abdominal pressure. Continuously monitor intra-abdominal pressure over the course of the entire insufflation if additional sources are used.



WARNING!

Please read the general risks and dangers information in chapter 2.1 Hazards, page 5 and chapter 3.3 General Device-Inherent Dangers, page 8.



EN

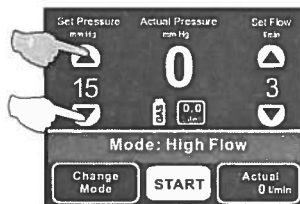
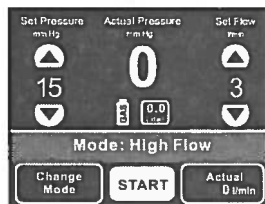
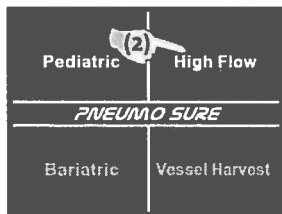
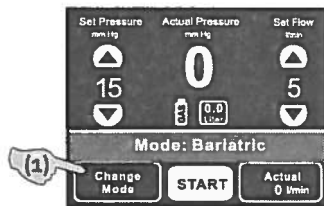

6.2 Selecting High Flow Insufflation Mode

1. Selection of the insufflation mode can be done only while insufflation is stopped. If High Flow operating mode is not yet set and displayed, press the function field **Change Mode** for 2 seconds to get the insufflation mode overview.
2. The display depicts the different insufflation operating modes that can be activated. Select the desired insufflation operating mode by pressing the **High Flow** function field. *Inactive operating modes are displayed in gray.
3. The procedure profile is depicted on the display. The displayed parameters correspond with the factory settings or the values set in the Configuration menu (see chapter 10.1 Configuration menu I, page 60).

6.3 Presetting Nominal Pressure in High Flow Operating Mode

The nominal pressure can be set during insufflation or while insufflation is stopped. Values may range from **1 to max. 30 mm Hg** or the value set in the Configuration menu.

Increasing/decreasing nominal pressure:

Briefly press the **▲** or **▼** function field to increase or decrease the pressure. Keeping the **▲** or **▼** function field depressed longer than 1.5 seconds activates scrolling in increments of 1.

Safety limit:

When **increasing** the nominal pressure, the status line of the display depicts **Safety limit** when reaching a value of **15 mm Hg**. The nominal pressure **15 mm Hg** is a threshold value. This is where the recommended range for the intra-abdominal pressure ends. Pressing the nominal pressure **▲** function field again does not increase the pressure any further. Release the function field for 2 seconds. Now you can set a value up to 30 mm Hg.

CAUTION!

Exceeding this safety limit is to be decided by and the responsibility of the user/operator.

6.4 Presetting Nominal Flow in High Flow Operating Mode

The nominal flow can be set during insufflation or while insufflation is stopped.

1. Briefly press the **▲** or **▼** function field to increase or decrease the flow. The nominal flow can be increased from **1 to max. 40 l/min**.
 - Briefly press the corresponding field to set values in increments of 1.

- Keeping the ▲ or ▼ function field pressed longer than 1.5 seconds activates scrolling through the gas flow rates 3, 20, 40 l/min or 40, 20, 3 l/min.
2. The preset values of the Configuration menu can be changed individually (see chapter 10.1 Configuration menu I, page 60). Select a nominal gas flow between 1-40 l/min. The preset value is indicated in the nominal gas flow display. The values for the nominal gas flow refer to a device without connected tube, filter, or instrument. Tube, filter, and instrument can reduce the gas flow.

The device monitors the gas flow in two different operating modes depicted in the status line with the following messages:

- **Veress insufflation** (1-5 l/min)
- **Insufflation: High Flow** (6-40 l/min)

Veress insufflation operating mode:

Veress insufflation is a gentle type of insufflation so that the actual pressure does not exceed the preset pressure even in case of small volumes. To minimize the risks in case of a faulty incision, the manufacturer recommends using **Veress insufflation** to start a procedure (filling abdomen with CO₂).

CAUTION!

Please note that the automatic venting system is not active during Veress insufflation mode.

Insufflation: High Flow

While **Insufflation: High Flow** any pressure loss due to leaks can be quickly equalized. The APC Technology (Advanced Pressure Control) enables raising the actual pressure gently to the level of the nominal pressure. In case of large volumes, the actual pressure does not exceed the nominal pressure (see chapter 11 Safety functions, page 70).

Start the device by pressing the **START** function field.

With a nominal flow setting of < 6 l/min **Veress insufflation** is displayed. Above 5 l/min **Insufflation: High Flow** is displayed.

Stop the device by pressing the **STOP** function field.

NOTE!

Tube, filter, and instrument can reduce the gas flow.

6.5 Performing the Function Test in High Flow Operating Mode

Sterilize reusable instruments and tubing before surgery to prevent infections. Check all the single-use/disposable items before removing them from the package to ensure that the packaging is intact and that the expiration date is still valid.

For your own safety and that of your patient, use only original accessories.

WARNING!

The function test must be performed prior to each surgical procedure.

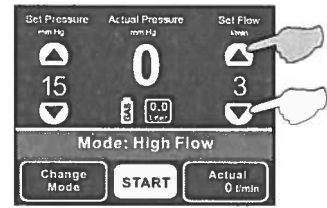

EN



Preparation



EN

Testing the device

Fig. 6-1 Layout for testing the device

- ① ON/OFF switch
- ② Nominal pressure display
- ③ START/STOP function field
- ④ Gas consumption display
- ⑤ Nominal flow display
- ⑥ Insufflation tube set
- ⑦ Stopcock (valve)
- ⑧ Veress cannula

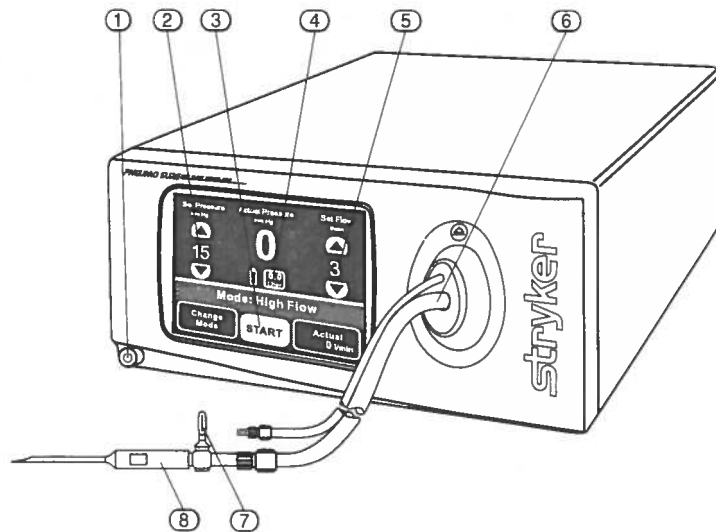

1. The device is switched off, no tube set is connected.
2. Make sure the gas supply is connected and open.
3. Use the ON/OFF switch ① to turn the device on. The device conducts a device check.
4. Select High Insufflation operating mode in the insufflation mode selection.
5. Connect an original insufflation tube set ⑥ to the device.
6. Attach the insufflation tube to the Veress cannula ⑧.
7. Attach the stopcock (valve) to the Veress cannula ⑦.
8. If the gas consumption display function field does depict a value, press the ④ function field to reset the display to 0.
9. Select the nominal pressure 15 mm Hg ② and the gas flow 3 l/min ⑤.
10. Start insufflation: Press the **START** function field ③.
11. The display status line depicts **Occlusion** after max. 4 seconds.
12. Stop insufflation: Press the **STOP** function field ③.

**WARNING!**

If the actual gas consumption is higher than 0.4 l, there is a leak in the system. If this happens, use steps 13 to 15 outlined below to locate the leak.

13. Repeat items 7 to 11 without Veress cannula and with closed tube end. The previously connected Veress cannula has a leak if gas consumption is now below 0.4 l.
14. Repeat items 8 to 12 without Veress cannula and without tube if another leak becomes apparent. Close the end of the insufflation tube connection for this test. If the gas consumption is then below 0.4 l, the previously used tube set has a leak.
15. If another leak is detected, this leak is then directly within the device. Make sure the device can no longer be operated until a qualified service technician conducts the appropriate tests and repairs.

**WARNING!**

Never work with a leaky insufflation tube, accessory, and/or device. This can lead to an incorrect measurement of the actual pressure values, which can cause an uncontrolled pressure increase in the abdomen.

Testing gas heating functionality

The functionality of the gas heating is indicated by displaying the gas heating symbol on the display when using the "Heated tube set with RTP for Pneumo

Sure".

1. Connect the corresponding tube set ("Heated with Real-Time Pressure Sensing" or "High Flow with Real-Time Pressure Sensing").
2. Insufflation is initially always started intermittently. Availability of the "Real-Time Pressure Sensing" functionality is checked automatically. If this is the case, the device switches to a continuous mode. This is indicated by the corresponding symbol on the display.

"Real-Time Pressure Sensing" functionality (RTP)

6.5.1 Filling Tube System with CO2

At least 1 l of CO2 has to be let out from the system before every surgery while the tube is connected and the end of the tube is open. This will expel any air within the tube system and the device.

1. Start insufflation: Press the **START** function field.
Wait until the gas consumption display shows **1.0 Liter**.
2. Stop insufflation: Press the **STOP** function field.
3. Press the gas consumption display field to reset the gas consumption display to **0.0 Liter**. This ensures the gas consumption is correctly displayed during surgery.

The function test is complete. The device is tested and ready to be used for surgery.

WARNING!

Do not use this device if a defect is suspected or detected during the function check. This also applies to obvious defects, especially defects on the power plug and power cable.



6.6 Using the Device during Surgery

Using the device during surgery

WARNING!

The function test must be performed prior to each surgery.



CAUTION!

The venting system is automatically triggered (not during Veress mode and not if the venting valve has been deactivated in the Configuration menu) if the measured actual pressure exceeds the set nominal pressure during insufflation. The device interrupts insufflation and releases gas until the actual pressure has dropped below the set nominal value.



1. The device is turned on.
2. An insufflation tube set is connected.

6.6.1 Insufflating with Veress Cannula

On delivery from the factory, following values are set for High Flow operating mode:

- a gas flow value of 3 l/min and
- Veress insufflation for insufflation through the Veress cannula.

CAUTION!

Up to 5 l/min Veress insufflation is set automatically. Please note that the automatic venting system is not active during Veress insufflation operating mode (the venting valve is switched off automatically). The gas transport through the



EN



device is also specifically customized for use with a Veress cannula.

WARNING!

This manual does not include instructions for the safe use of the Veress cannula. Only when you have ensured endoscopically that an aeroperitoneum can be generated, should a gas flow of more than 3 l/min and a pressure of more than 10 mm Hg be selected. Insert the Veress cannula into the abdomen. Check to see if the Veress cannula is correctly positioned in the abdomen.

1. Attach the insufflation tube to the Veress cannula.
2. Select the desired nominal pressure and nominal gas flow.
3. Start insufflation: Press the **START** function field.
Check the actual pressure display and the gas consumption display.

6.6.2 Insufflating with the Trocar

1. Insert the trocar into the abdomen.
2. Connect the Luer Lock connection of the insufflation tube to the trocar.
3. Make sure the trocar is correctly positioned in the abdomen. Then select the desired pressure and desired gas flow as intraoperative conditions.
4. The actual pressure display shows the current measured value for insufflation. As soon as this value approximates the selected nominal value, the gas flow is automatically minimized. The gas consumption display shows the volume of gas consumed.
5. Check how the patient's body reacts to the selected pressure and gas flow rate. Compare the abdominal filling rate to the selected nominal pressure. You can change the nominal gas flow and the nominal pressure during surgery without interrupting the insufflation process.

6.6.3 "Real-Time Pressure Sensing" functionality (RTP)

To use the "Real-Time Pressure Sensing" (RTP) please use a tube set with measuring line. The Luer Lock connection of the measuring tube has to be connected to another trocar placed during the surgery. This enables the continuous measuring of the pressure (see 5.5 Connecting Insufflation Tube Set, page 19 and 5.6.1 Using the direct pressure measurement function (Real-Time Pressure Sensing RTP), page 21).

CAUTION!

Make sure the stopcock (valve) of the trocar is fully opened and that both tube connections are connected to different trocars.

6.6.4 Stop the Insufflation

1. Press the **STOP** function field. The following values are displayed:
 - Gas consumption display: last measured value
 - Actual pressure: current measured value
 - Actual gas flow: 0 l/min
 - Nominal pressure: last set value In case of exceeding the safety limit, the nominal pressure value will be reset to the safety limit value.
 - Nominal gas flow: last set value

The status field of the display depicts **Insufflation stopped** followed by **Mode: High Flow** alternating with **Push  to release**.

2. Remove the tube set from the device. Observe applicable hygiene regulations when disposing of the tube set.
-

CAUTION!

If the tube set remains connected to the device, there is the danger that leftover

fluid in the tube or the instruments will be sucked into the device.

3. Close the gas supply.
 4. Use the ON/OFF switch to turn the device off.
-

NOTE!

Observe applicable hygiene regulations when disposing of the tube set.

EN



EN

Pediatric operating mode

7 Using and Controlling the PNEUMO SURE High Flow Insufflator in Pediatric Operating Mode

Pediatric operating mode is designed specifically for use on newborns, infants, and children. While in Pediatric operating mode, the insufflator limits the pressure to max. 20 mm Hg and the gas flow rate to max. 20 l/min. When used on children, the device should be set depending on the selected nominal flow and the age and weight of the treated child as outlined in the table below:

Age Group	Weight	Flow Range
Children younger than 1 year	approx. 1-9 kg	0.1 -0.5 l/min
Children between 1 and 3 years	approx. 10-15 kg	0.5 -1.0 l/min
Children between 3 and 4 years	approx. 16-19 kg	1.0 -2.0 l/min
Children between 4 and 14 years	> 20 kg	> 2.0 l/min
All children	< 25 kg	< 14.0 l/min

If the nominal flow is set too low, the nominal pressure cannot be reached. Check for possible leaks. Due to the special operating method used during the Pediatric application, the speed of equalizing the leak is slower than when using the High Flow application (lower effective flow in the Pediatric application).

Contraindications

The device may not be used to fill an abdomen with CO₂ if a laparoscopy is contraindicated. Please consult the manual of your laparoscope for absolute and relative contraindications. The device is not suitable for hysteroscopic insufflations, i.e., it may not be used to distend the uterus.

The gas flow may not exceed 14 l/min when performing a laparoscopy on infants or patients weighing less than 25 kilos.

7.1 Device-Specific Dangers when Using the PNEUMO SURE High Flow Insufflator in Pediatric Operating Mode



WARNING!

Only specially trained and qualified personnel may use this device on children or for the endoscopic vessel harvesting procedure.



WARNING!

Gas flow limit

The gas flow may not exceed 14 l/min when performing a laparoscopy on newborns or patients weighing less than 25 kg (approx. 55 US pounds).



WARNING!

Recommended work settings

The flow values listed above for laparoscopic procedures performed on newborns, infants, and children are only suggested values. The selection of the suitable flow and pressure values is solely the responsibility of the attending physician. However, adhering to the values listed above ensures an optimal performance of the Pediatric operating mode of the insufflator.



WARNING!

Pneumolabium/pneumoscrotum

Children are at risk of a pneumolabium or pneumoscrotum.

WARNING!**Increased airway pressure**

When laparoscopic procedures are performed on children, the increased intra-abdominal pressure also increases the risk for higher airway pressures. Always strictly monitor respiration and airway function when performing laparoscopic procedures on children younger than 12 years of age.

**WARNING!****Compression of the vena cava**

When insufflating the abdomen of a child with medical CO₂, an increased risk of compressing the vena cava exists. This risk can be reduced by monitoring the systolic and diastolic blood pressure during the entire surgery.

**WARNING!****Haemodynamic stability**

A laparoscopy performed on children younger than 12 years of age can result in the phenomenon of the increased CO₂ content in the blood and with that to problems of the haemodynamic system. It is recommended to increase the breathing rate of the patient and to work with low flow values and pressure values not exceeding 12 mm Hg. The patient's circulatory system should be monitored at all times.

**WARNING!****Hypothermia**

The insufflation gas flow usually drops significantly after the target pressure has been reached and it is then only required to maintain the abdominal pressure. However, leaks within the abdomen or the instrument can lead to a constant gas flow of above 1 l/min. When operating on children younger than 12, a gas flow of more than 1 l/min poses an increased risk of hypothermia for the patient. Corresponding measures to prevent hypothermia include the use of blankets or pre-warmed gas. The patient's body temperature has to be monitored at all times during surgery.

**WARNING!****Device-inherent dangers**

Please read the general risks and dangers information in chapter 2.1 Hazards, page 5 and chapter 3.3 General Device-Inherent Dangers, page 8.



EN

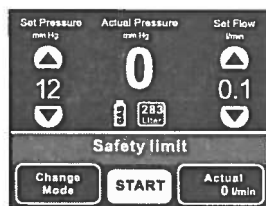
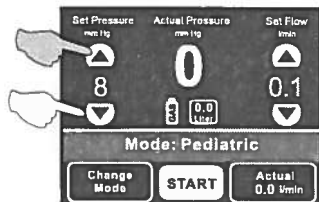
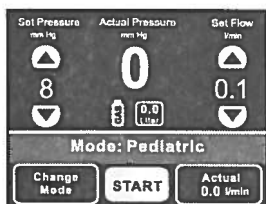
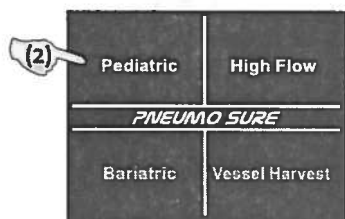
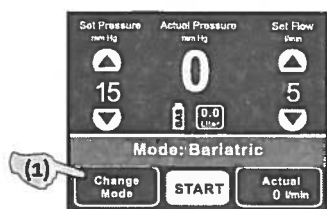

7.2 Selecting Pediatric Operating Mode

1. Selection of the insufflation mode can be done only while insufflation is stopped. If Pediatric operating mode is not yet set and displayed, press the function field **Change Mode** for 2 seconds to get the insufflation mode overview.
2. The display depicts an insufflation modes overview. Select the desired insufflation operating mode by pressing the **Pediatric** function field.
3. The procedure profile is depicted on the display. The displayed parameters correspond with the factory settings or the values set in the Configuration menu (see chapter 10 Configuration Menu (Overview), page 58).

7.3 Presetting Nominal Pressure in Pediatric Operating Mode

The nominal pressure can be set during insufflation or while insufflation is stopped. Values may range from **1 to max. 20 mm Hg** or the value set in the Configuration menu.

Increasing/decreasing nominal pressure:

Briefly press the **▲** or **▼** function field to increase or decrease the pressure. Keeping the **▲** or **▼** function field depressed longer than 1.5 seconds activates scrolling in increments of 1.

Select a nominal pressure value between 1 and 20 mm Hg. The preset value is indicated in the nominal pressure display.

Safety limit:

When **increasing** the nominal pressure, the status line of the display depicts **Safety limit** starting at **12 mm Hg** and the nominal value flashes.

The nominal pressure value **12 mm Hg** is a limit value and should not be exceeded for newborns if at all possible. Pressing the nominal pressure **▲** function field again does not increase the pressure any further.

CAUTION!
Exceeding this safety limit is to be decided by and the responsibility of the user/operator.

Release the function field at that point. The display switches back to the nominal value setting after 2 seconds. Now you can set a value up to **15 mm Hg**. The nominal pressure **15 mm Hg** is a limit value. This is where the recommended range for

the intra-abdominal pressure ends. Pressing the nominal pressure function field again does not increase the pressure any further. The status line of the display depicts **Safety limit** and the nominal value flashes.

Release the function field at that point. The display switches back to the nominal value setting after 2 seconds. Now you can set a value up to **20 mm Hg**.

7.4 Presetting Nominal Flow in Pediatric Operating Mode

The nominal flow can be set during insufflation or while insufflation is stopped.

Reducing nominal gas flow:

Press the nominal gas flow function field ▼ to reduce the nominal gas flow. The nominal gas flow is decreased in the range of

- 0.1 l/min to 2 l/min in increments of 0.1 l/min.
- 2 l/min to 20 l/min in increments of 1 l/min.

Keeping the ▼ function field depressed longer than 1.5 seconds activates scrolling.

- In the range of 0.1...2 l/min, rounding down to 1 or 0.1 l/min is applied.
- In the range of 2...20 l/min in increments of 1.

The nominal flow can be set during insufflation or while insufflation is stopped.

Increasing nominal gas flow:

Press the nominal gas flow function field ▲ to increase the nominal gas flow. The nominal gas flow is increased in the range of

- 0.1 l/min to 2 l/min in increments of 0.1 l/min.
- 2 l/min to 20 l/min in increments of 1 l/min.

Keeping the ▲ function field depressed longer than 1.5 seconds activates scrolling.

- In the range of 0.1 l/min...<2 l/min, rounding up to 1 or 2 l/min is applied.
- Then in one-step increments down to 20 l/min.

Safety limit:

When increasing the nominal flow, the status line of the display depicts **Safety limit** starting at **5 l/min** and the nominal value flashes. (This safety limit can be activated or deactivated in the Configuration menu).

Release the function field to increase the nominal gas flow further. The display switches back to the nominal value setting after 2 seconds. Now you can set a value of up to 20 l/min.

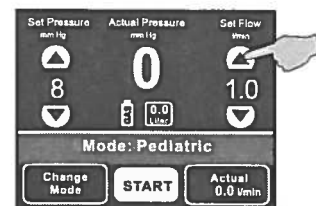
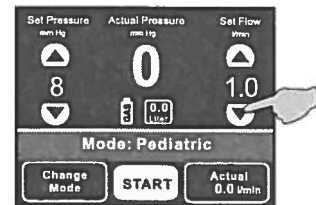

WARNING!

Exceeding this safety limit is to be decided by and the responsibility of the user/operator.

EN

Veress insufflation**Veress insufflation operating mode:**

The device monitors the gas flow in two different operating modes:

- **Veress insufflation** (≤ 1 l/min)
- **Insufflation: Pediatric** (> 1 l/min)

Veress insufflation is intended for the gentle development of a pneumoperitoneum. The nominal gas flow emitted by the device in this case is very low (in the range of 0.1 l/min to 1 l/min).

To minimize the risks in case of a faulty incision, the manufacturer recommends using **Veress insufflation** to start a procedure (filling abdomen with CO₂).

Start the device by pressing the **START** function field.

CAUTION!

Please note that the automatic venting system is only active during the **Veress insufflation** mode if "In Veress insufflation ON" has been set in the configuration menu (only possible in **Pediatric** operating mode, see chapter 10 Configuration Menu (Overview), page 58).

Venting system "In Veress insufflation OFF"

With a nominal flow setting of ≤ 1 l/min, **Veress insufflation** is displayed in the status line after pressing the Start/Stop switch.

Above 1 l/min, **Insufflation: Pediatric** is displayed.

Venting system "In Veress insufflation ON"

With this setting, after pressing the **START** function field **Insufflation: Pediatric** is displayed, even if the nominal flow is set to ≤ 1 l/min.

While **Insufflation: Pediatric** any pressure loss due to leaks can be quickly equalized. The APC Technology (Advanced Pressure Control) enables raising the actual pressure gently to the level of the nominal pressure.

NOTE!

Tube, filter and instrument can reduce the gas flow.

Insufflation: Pediatric**Preparation****7.5 Performing the Function Test in Pediatric Operating Mode before Using the Device during Surgery**

Sterilize reusable instruments and tubing before surgery to prevent infections. Check all the single-use/disposable items before removing them from the package to ensure that the packaging is intact and that the expiration date is still valid.

For your own safety and that of your patient, use only original accessories.

WARNING!

The function test must be performed prior to each surgical procedure.

Testing the device

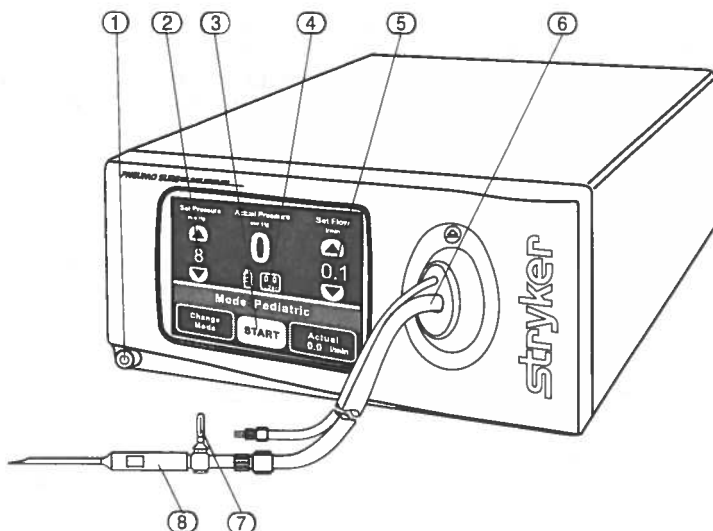

Fig. 7-1 Layout for testing the device

- ① ON/OFF switch
- ② Nominal pressure display
- ③ START/STOP function field
- ④ Gas consumption display
- ⑤ Nominal flow display
- ⑥ Insufflation tube set
- ⑦ Stopcock (valve)
- ⑧ Veress cannula

1. The device is switched off, no tube set is connected.
2. Make sure the gas supply is connected and open.
3. Use the ON/OFF switch ① to turn the device on. The device conducts a device check.
4. Select Pediatric operating mode in the insufflation mode selection.
5. Connect an original insufflation tube set ⑥ to the device.
6. Attach the insufflation tube to the Veress cannula ⑧.
7. Attach the stopcock (valve) ⑦ to the Veress cannula.
8. If the gas consumption display function field does depict a value, press the ④ function field to reset the display to 0.
9. Select the nominal pressure 8 mm Hg ② and the gas flow 2 l/min ⑤.
10. Start insufflation: Press the START function field ③.
11. Insufflate for approx. 30 s. The display status line depicts **Occlusion** after max. 4 seconds.
12. Stop insufflation: Press the STOP function field ③.

WARNING!

If the actual gas consumption is higher than 0.4 l, there is a leak in the system. If this happens, use steps 13 to 15 outlined below to locate the leak.



13. Repeat items 7 to 11 without Veress cannula and with closed tube end. The previously connected Veress cannula has a leak if gas consumption is now below 0.4 l.
14. Repeat items 8 to 12 without Veress cannula and without tube if another leak becomes apparent. Close the end of the insufflation tube connection for this test. If the gas consumption is then below 0.4 l, the previously used tube set has a leak.
15. If another leak is detected, this leak is then directly within the device. Make sure the device can no longer be operated until a qualified service technician conducts the appropriate tests and repairs.

WARNING!

Never work with a leaky insufflation tube, accessory, and/or device. This can lead to an incorrect measurement of the actual pressure values, which can cause an uncontrolled pressure increase in the abdomen.



The functionality of the gas heating is indicated by displaying the gas heating

Testing gas heating functionality

EN

"Real-Time Pressure Sensing" functionality (RTP)

symbol on the display when using the "Heated tube set with RTP for Pneumo Sure".

1. Connect the corresponding tube set ("Heated with Real-Time Pressure Sensing" or "High Flow with Real-Time Pressure Sensing").
2. Insufflation is initially always started intermittently. Availability of the "Real-Time Pressure Sensing" functionality is checked automatically. If this is the case, the device switches to a continuous mode. This is indicated by the corresponding symbol on the display.

7.5.1 Filling Tube System with CO₂

At least 1 l of CO₂ has to be let out from the system before every surgery while the tube is connected and the end of the tube is open. This will expel any air within the tube system and the device.

1. Start insufflation: Press the **START** function field.
Wait until the gas consumption display shows **1.0 Liter**.
2. Stop insufflation: Press the **STOP** function field.
3. Press the gas consumption display field to reset the gas consumption display to **0.0 Liter**. This ensures the gas consumption is correctly displayed during surgery.

The function test is complete. The device is tested and ready to be used for surgery.

**WARNING!**

Do not use this device if a defect is suspected or detected during the function check. This also applies to obvious defects, especially defects on the power plug and power cable.

Using the device during surgery**7.6 Using the Device during Surgery****WARNING!**

The function test must be performed prior to each surgery.

**CAUTION!**

The venting system is automatically triggered (not during Veress mode and not if the venting valve has been deactivated in the Configuration menu) if the measured actual pressure exceeds the set nominal pressure during insufflation. The device interrupts insufflation and releases gas until the actual pressure has dropped below the set nominal value.

1. The device is turned on.
2. An insufflation tube set is connected.

7.6.1 Insufflating with Veress Cannula

On delivery from the factory, following values are set for Pediatric operating mode:

- a gas flow value of 0.1 l/min and
- Veress insufflation for insufflation through the Veress cannula.

**CAUTION!**

Please note that with flow values up to 1 l/min the Veress insufflation operating mode is automatically activated (the venting valve is switched off). The gas

transport is also specifically customized for use with a Veress cannula.

WARNING!

This manual does not include instructions for the safe use of the Veress cannula. Only when you have ensured endoscopically that an aeroperitoneum can be generated, should a gas flow of more than 3 l/min and a pressure of more than 10 mm Hg be selected (see corresponding setting for children, chapter 3.1.2 Using Pediatric Operating Mode, page 7). Insert the Veress cannula into the abdomen. Check to see if the Veress cannula is correctly positioned in the abdomen.



1. Attach the insufflation tube to the Veress cannula.
2. Select the desired nominal pressure and nominal gas flow.
3. Start insufflation: Press the **START** function field.
Check the actual pressure display and the gas consumption display.

7.6.2 Insufflating with the Trocar

1. Insert the trocar into the abdomen.
2. Connect the Luer Lock connection of the insufflation tube to the trocar.
3. Make sure the trocar is correctly positioned in the abdomen. Then select the desired pressure and desired gas flow as intraoperative conditions.
4. The actual pressure display shows the current measured value for insufflation. As soon as this value approximates the selected nominal value, the gas flow is automatically minimized. The gas consumption display shows the volume of gas consumed.
5. Check how the patient's body reacts to the selected pressure and gas flow rate. Compare the abdominal filling rate to the selected nominal pressure. You can change the nominal gas flow and the nominal pressure during surgery without interrupting the insufflation process.

7.6.3 "Real-Time Pressure Sensing" functionality (RTP)

To use the "Real-Time Pressure Sensing" (RTP) please use a tube set with measuring line. The Luer Lock connection of the measuring tube has to be connected to another trocar placed during the surgery. This enables the continuous measuring of the pressure (see 5.5 Connecting Insufflation Tube Set, page 19 and 5.6.1 Using the direct pressure measurement function (Real-Time Pressure Sensing RTP), page 21).

CAUTION!

Make sure the stopcock (valve) of the trocar is fully opened and that both tube connections are connected to different trocars.



7.6.4 Stop the Insufflation

1. Press the **STOP** function field. The following values are displayed:
 - Gas consumption display: last measured value
 - Actual pressure: current measured value
 - Actual gas flow: 0 l/min
 - Nominal pressure: last set value In case of exceeding the safety limit, the nominal pressure value will be reset to the lowest safety limit value.
 - Nominal gas flow: last set value In case of exceeding the safety limit, the nominal flow value will be reset to the safety limit value (only if activated).

The status field of the display depicts **Insufflation stopped** followed by **Mode: Pediatric** alternating with **Push**  **to release**.
2. Remove the tube set from the device. Observe applicable hygiene regulations

EN



when disposing of the tube set.

CAUTION!

If the tube set remains connected to the device, there is the danger that leftover fluid in the tube or the instruments will be sucked into the device.

3. Close the gas supply.
 4. Use the ON/OFF switch to turn the device off.
-



NOTE!

Observe applicable hygiene regulations when disposing of the tube set.

8 Using and Controlling the PNEUMO SURE XL High Flow Insufflator in Bariatric Operating Mode

Bariatric operating mode is used for laparoscopies performed on severely overweight (BMI > 30 kg/m²) adults. While in Bariatric mode, the insufflator limits the pressure to max. 30 mm Hg and the gas flow to max. 45 l/min. This operating mode delivers rapid insufflation of large volumes.

Intended use

The device may not be used to fill an abdomen with CO₂ if a laparoscopy is contraindicated. Please consult the manual of your laparoscope for absolute and relative contraindications. The device is not suitable for hysteroscopic insufflations, i.e., it may not be used to distend the uterus.

Contraindications

The gas flow may not exceed 14 l/min when performing a laparoscopy on infants or patients weighing less than 25 kilos.

8.1 Device-Specific Dangers when Using the PNEUMO SURE High Flow Insufflator in Bariatric Operating Mode

WARNING!

Altered Respiratory Physiology

Always monitor the patient's respiratory functions during the entire surgery. The larger body mass supported by the thoracic cage and the larger amount of fat in the abdominal cavity may reduce the elasticity of the thoracic wall. In addition, the increased intra-abdominal pressure secondary to insufflation may alter the normal physiological lung parameters thus resulting in a reduction of the functional lung volume. Shallow, rapid breathing is symptomatic of this condition. Even modest physical stress causes a tremendous increased demand for oxygen, which stands in contrast to the ineffective respiratory musculature that requires more oxygen because it must overcome the reduced elasticity of the thoracic cage. The functional capacity of the lungs is small and even moderate stress can lead to respiratory failure.



WARNING!

Subcutaneous Emphysema

When puncturing the thicker abdominal wall of morbidly obese patients with the Veress cannula or the trocar, carefully monitor the correct position of the instrument in the abdomen.



WARNING!

Idiosyncratic reactions

Patients with sickle cell anemia or pulmonary insufficiency may have a higher risk of metabolic imbalance related to excessive CO₂ absorption (idiosyncratic reaction).



WARNING!

CO₂ absorption

CO₂ is absorbed during insufflation (intravasation). This means the body absorbs part of the CO₂ gas used for insufflation. CO₂ concentrations in the blood or respiratory system that are too high can lead to death of the patient in extreme cases. To lower this risk, always carefully and closely monitor the patient's vital signs during the entire insufflation process and make sure patient is breathing well. Sufficient respiration can help avoid or limit problems with CO₂. High pressure or a high gas flow promotes CO₂ absorption. The abdomen is sufficiently distended using a pressure between 10 to 15 mm Hg. Pressure values above 15 mm Hg are required for only a few cases but do increase the risk of intravasation. Never exceed the max. intra-abdominal pressure of 30 mm Hg.



EN

**WARNING!****CO₂ supersaturation**

To avoid generating CO₂ supersaturation, an increased level of respiratory activity is required. An overweight patient's oxygen demand and carbon dioxide production are greater and increase faster under physical stress than do those of patients with normal body weight.

**WARNING!****Heart and cardiovascular insufficiency**

Constantly monitor all heart and cardiovascular parameter during surgery since morbidly obese patients have an increased risk of heart and cardiovascular insufficiencies.

**WARNING!****Metabolic and cardiac reactions**

Insufflating CO₂ may result in metabolic acidosis. This can lead to cardiac irregularities expressed with the following symptoms:

- Reduced respiration with restricted diaphragm function
- Hypercapnia
- Reduction of venous reflux
- Reduced cardiac output
- Metabolic acidosis

**WARNING!****Hypothermia/monitoring body temperature**

The gas flow can lead to a lowering of the patient's body temperature during insufflation. Hypothermia during insufflation can cause heart and cardiovascular problems. The risk for hypothermia can be significantly reduced with the use of gas that is pre-warmed to body temperature. Always monitor the patient's body temperature during the entire insufflation. Make especially sure that the following, hypothermia promoting, surgical conditions are avoided as best as possible:

- High gas flow due to large leaks
- Long surgeries
- Use of cold (not preheated) irrigation and infusion solutions

**WARNING!****Dehydration**

Insufflation can lead to dehydration of the tissue. This can result in organ tissue damage and cardiovascular reactions of the patient. Long surgeries and large leaks increase the risk of dehydration (especially at the insertion points of the trocars or when changing instruments).

WARNING!

Embolism

Improper placement of the insufflation instrument could cause insufflation of gas into a vessel, resulting in air or CO2 embolisms. To reduce the risk of air or CO2 embolism, perform initial insufflation at a low flow rate and ensure that the insufflation instrument is correctly positioned. Check the position of the insufflation instrument immediately if the actual pressure rapidly reaches the nominal pressure value. CO2 embolisms can also be caused by a high intra-abdominal pressure. Avoid high-pressure settings and close damaged blood vessels at once.



WARNING!

Additional insufflation sources

The use of additional insufflation sources increases the intra-abdominal pressure. Continuously monitor intra-abdominal pressure over the course of the entire insufflation if additional sources are used.



WARNING!

Device-inherent dangers

Please read the general risks and dangers information in chapter 2.1 Hazards, page 5 and chapter 3.3 General Device-Inherent Dangers, page 8.



8.2 Selecting Bariatric Operating Mode

- Selection of the insufflation mode can be done only while insufflation is stopped. If Bariatric operating mode is not yet set and displayed, press the function field **Change Mode** for 2 seconds to get the insufflation mode overview.
- The display depicts an insufflation modes overview. Select the desired insufflation operating mode by pressing the **Bariatric** function field. *Inactive operating modes are displayed in gray.
- The procedure profile is depicted on the display. The displayed parameters correspond with the factory settings or the values set in the Configuration menu (see chapter 10.1 Configuration menu I, page 60).

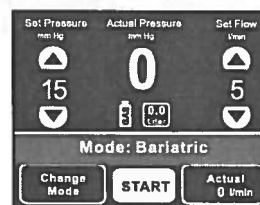
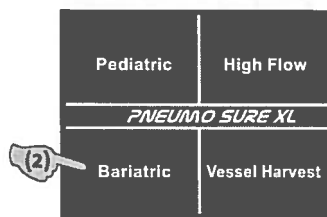
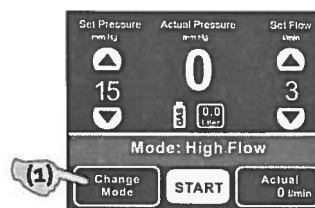

EN

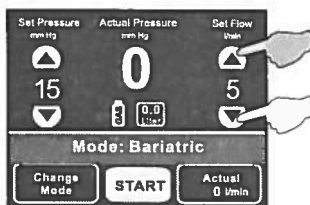
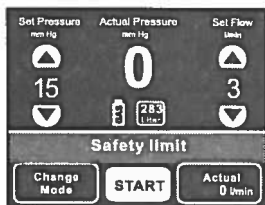
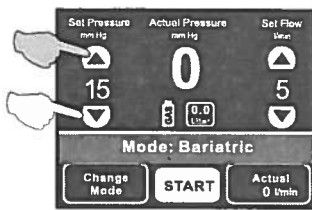

8.3 Presetting Nominal Pressure in Bariatric Operating Mode

The nominal pressure can be set during insufflation or while insufflation is stopped. Values may range from **1 to max. 30 mm Hg** or the value set in the Configuration menu.

Increasing/decreasing nominal pressure:

Briefly press the **▲** or **▼** function field to increase or decrease the pressure. Keeping the **▲** or **▼** function field depressed longer than 1.5 seconds activates scrolling in increments of 1.

Safety limit:

When **increasing** the nominal pressure, the status line of the display depicts **Safety limit** starting at **15 mm Hg** and the nominal value flashes. The nominal pressure **15 mm Hg** is a threshold value. This is where the recommended range for the intra-abdominal pressure ends. Pressing the nominal pressure **▲** function field again does not increase the pressure any further. Release the function field at that point. The display switches back to the nominal value setting after 2 seconds. Now you can set a value up to 30 mm Hg.

CAUTION!

Exceeding this safety limit is to be decided by and the responsibility of the user/operator.

8.4 Presetting Nominal Flow in Bariatric Operating Mode

The nominal flow can be increased or decreased during insufflation or while insufflation is stopped.

- Briefly press the **▲** or **▼** function field to increase or decrease the flow. The nominal flow can be increased from **1 to max. 45 l/min**.
 - Briefly press the corresponding field to set values in increments of 1.
 - Keeping the **▲** or **▼** function field pressed longer than 1.5 seconds activates scrolling through the gas flow rates 5, 25, 45 l/min or 45, 25, 5 l/min.
- The preset values of the Configuration menu can be changed individually (see chapter 10.1 Configuration menu I, page 60). Select a nominal gas flow between 1-45 l/min. The preset value is indicated in the nominal gas flow display. The values for the nominal gas flow refer to a device without connected tube, filter, or instrument. Tube, filter, and instrument can reduce the gas flow.

The device monitors the gas flow in two different operating modes:

- Veress insufflation (1-5 l/min)**
- Insufflation: Bariatric (6-45 l/min)**

Veress insufflation operating mode:

Veress insufflation is a gentle type of insufflation so that the actual pressure does not exceed the preset pressure even in case of small volumes. To minimize the risks in case of a faulty incision, the manufacturer recommends using **Veress insufflation** to start a procedure (filling abdomen with CO₂).

WARNING!

Please note that the automatic venting system is not active during Veress insufflation mode.

Insufflation: Bariatric

While **Insufflation: Bariatric** any pressure loss due to leaks can be quickly equalized. The APC Technology (Advanced Pressure Control) enables raising the actual pressure gently to the level of the nominal pressure. In case of large volumes, the actual pressure does not exceed the nominal pressure (see chapter 11 Safety functions, page 70).

Start the device by pressing the **START** function field.

With a nominal flow setting of < 6 l/min **Veress insufflation** is displayed. Above 5 l/min **Insufflation: Bariatric** is displayed.

Stop the device by pressing the **STOP** function field.



NOTE!

Tube, filter and instrument can reduce the gas flow.



8.5 Performing the Function Test in Bariatric Operating Mode before Using the Device during Surgery

Sterilize reusable instruments and tubing before surgery to prevent infections. Check all the single-use/disposable items before removing them from the package to ensure that the packaging is intact and that the expiration date is still valid.

For your own safety and that of your patient, use only original accessories.

Preparation

WARNING!

The function test must be performed prior to each surgical procedure.



Testing the device

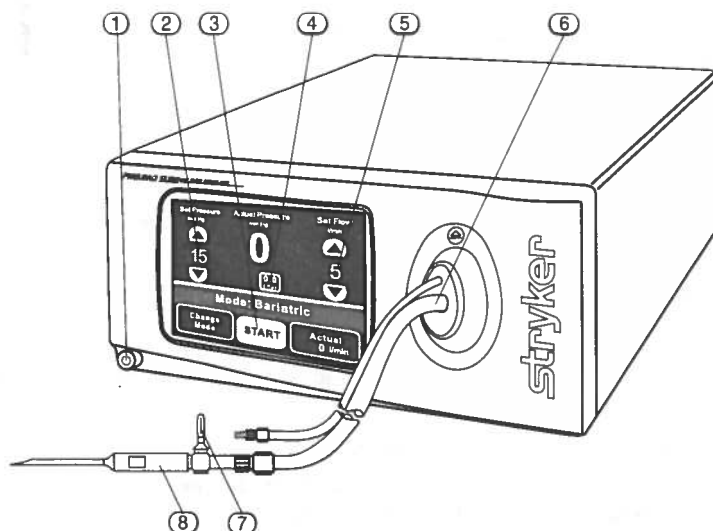

Fig. 8-1 Layout for testing the device

- ① ON/OFF switch
- ② Nominal pressure display
- ③ START/STOP function field
- ④ Gas consumption display
- ⑤ Nominal flow display
- ⑥ Insufflation tube set
- ⑦ Stopcock (valve)
- ⑧ Veress cannula

1. The device is switched off, no tube set is connected.
2. Make sure the gas supply is connected and open.
3. Use the ON/OFF switch ① to turn the device on. The device conducts a de-

EN

vice check.

4. Select Bariatric operating mode in the insufflation mode selection.
5. Connect an original insufflation tube set (6) to the device.
6. Attach the insufflation tube to the Veress cannula (8).
7. Attach the stopcock (valve) (7) to the Veress cannula.
8. If the gas consumption display function field does depict a value, press the (4) function field to reset the display to 0.
9. Select the nominal pressure 15 mm Hg (2) and the gas flow 5 l/min (5).
10. Start insufflation: Press the **START** function field (3).
11. Insufflate for approx. 30 s. The display status line depicts **Occlusion** after max. 4 seconds.
12. Stop insufflation: Press the **STOP** function field (3).

**WARNING!**

If the actual gas consumption is higher than 0.4 l, there is a leak in the system. If this happens, use steps 13 to 15 outlined below to locate the leak.

13. Repeat items 7 to 11 without Veress cannula and with closed tube end. The previously connected Veress cannula has a leak if gas consumption is now below 0.4 l.
14. Repeat items 8 to 12 without Veress cannula and without tube if another leak becomes apparent. Close the end of the insufflation tube connection for this test. If the gas consumption is then below 0.4 l, the previously used tube set has a leak.
15. If another leak is detected, this leak is then directly within the device. Make sure the device can no longer be operated until a qualified service technician conducts the appropriate tests and repairs.

**WARNING!**

Never work with a leaky insufflation tube, accessory, and/or device. This can lead to an incorrect measurement of the actual pressure values, which can cause an uncontrolled pressure increase in the abdomen.

Testing gas heating functionality

The functionality of the gas heating is indicated by displaying the gas heating symbol on the display when using the "Heated tube set with RTP for Pneumo Sure".

"Real-Time Pressure Sensing" functionality (RTP)

1. Connect the corresponding tube set ("Heated with Real-Time Pressure Sensing" or "High Flow with Real-Time Pressure Sensing").
2. Insufflation is initially always started intermittently. Availability of the "Real-Time Pressure Sensing" functionality is checked automatically. If this is the case, the device switches to a continuous mode. This is indicated by the corresponding symbol on the display.

8.5.1 Filling Tube System with CO₂

At least 1 l of CO₂ has to be let out from the system before every surgery while the tube is connected and the end of the tube is open. This will expel any air within the tube system and the device.

1. Start insufflation: Press the **START** function field.
Wait until the gas consumption display shows **1.0 Liter**.
2. Stop insufflation: Press the **STOP** function field.
3. Press the gas consumption display field to reset the gas consumption display to **0.0 Liter**. This ensures the gas consumption is correctly displayed during surgery.

The function test is complete. The device is tested and ready to be used for surgery.

WARNING!

Do not use this device if a defect is suspected or detected during the function check. This also applies to obvious defects, especially defects on the power plug and power cable.



8.6 Using the Device during Surgery

Using the device during surgery

WARNING!

The function test must be performed prior to each surgery.

**CAUTION!**

The venting system is automatically triggered (not during Veress mode and not if the venting valve has been deactivated in the Configuration menu) if the measured actual pressure exceeds the set nominal pressure during insufflation. The device interrupts insufflation and releases gas until the actual pressure has dropped below the set nominal value.



1. The device is turned on.
2. An insufflation tube set is connected.

8.6.1 Insufflating with Veress Cannula

On delivery from the factory, following values are set for Bariatric operating mode:

- a gas flow value of 5 l/min and
- Veress insufflation for insufflation through the Veress cannula.

CAUTION!

Please note that with flow values up to 5 l/min the Veress insufflation operating mode is automatically activated (the venting valve is switched off). The gas transport is also specifically customized for use with a Veress cannula.

**WARNING!**

This manual does not include instructions for the safe use of the Veress cannula. Only when you have ensured endoscopically that an aeroperitoneum can be generated, should a gas flow of more than 3 l/min and a pressure of more than 10 mm Hg be selected. Insert the Veress cannula into the abdomen. Check to see if the Veress cannula is correctly positioned in the abdomen.



1. Attach the insufflation tube to the Veress cannula.
2. Select the desired nominal pressure and nominal gas flow.
3. Start insufflation: Press the **START** function field.
Check the actual pressure display and the gas consumption display.

8.6.2 Insufflating with the Trocar

1. Insert the trocar into the abdomen.
2. Connect the Luer Lock connection of the insufflation tube to the trocar.
3. Make sure the trocar is correctly positioned in the abdomen. Then select the desired pressure and desired gas flow as intraoperative conditions.
4. The actual pressure display shows the current measured value for insufflation. As soon as this value approximates the selected nominal value, the gas flow is automatically minimized. The gas consumption display shows the volume of gas consumed.
5. Check how the patient's body reacts to the selected pressure and gas flow

EN

rate. Compare the abdominal filling rate to the selected nominal pressure. You can change the nominal gas flow and the nominal pressure during surgery without interrupting the insufflation process. The Luer Lock connection of the measuring tube can be connected to another trocar that also inserted when using a tube set with measuring line. This enables the continuous measuring of the pressure.

8.6.3 "Real-Time Pressure Sensing" functionality (RTP)

To use the "Real-Time Pressure Sensing" (RTP) please use a tube set with measuring line. The Luer Lock connection of the measuring tube has to be connected to another trocar placed during the surgery. This enables the continuous measuring of the pressure (see 5.5 Connecting Insufflation Tube Set, page 19 and 5.6.1 Using the direct pressure measurement function (Real-Time Pressure Sensing RTP)).

CAUTION!

Make sure the stopcock (valve) of the trocar is fully opened and that both tube connections are connected to different trocars.



8.7 Stop the Insufflation

1. Press the **STOP** function field. The following values are displayed:
 - Gas consumption display: last measured value
 - Actual pressure: current measured value
 - Actual gas flow: 0 l/min
 - Nominal pressure: last set value In case of exceeding the safety limit, the nominal pressure value will be reset to the safety limit value.
 - Nominal gas flow: last set value

The status field of the display depicts **Insufflation stopped** followed by **Mode: Bariatric** alternating with **Push  to release.**
2. Remove the tube set from the device. Observe applicable hygiene regulations when disposing of the tube set.

CAUTION!

If the tube set remains connected to the device, there is the danger that leftover fluid in the tube or the instruments will be sucked into the device.



3. Close the gas supply.
4. Use the ON/OFF switch to turn the device off.

NOTE!

Observe applicable hygiene regulations when disposing of the tube set.



9 Using and Controlling the PNEUMO SURE XL High Flow Insufflator in Vessel Harvest Operating Mode

Vessel Harvest operating mode is designed for the controlled insufflation of medical-grade CO₂ when harvesting vessels (veins and arteries) during a minimally invasive procedure within the scope of heart bypass surgery. While in **Vessel Harvest** operating mode, the insufflator limits the pressure to max. 20 mm Hg and the gas flow rate to max. 10 l/min. Surgery to harvest vessels requires the use of a special instrument.

Intended use

The device may not be used for the endoscopic harvesting of vessels if this surgical application is contraindicated. Please consult the manual of that instrument for additional information and special application indications.

Contraindications

9.1 Device-Specific Dangers when Using the PNEUMO SURE XL High Flow Insufflator in Vessel Harvest Operating Mode

WARNING!

Only specially trained and qualified personnel may use this device on children or for the endoscopic vessel harvesting procedure.



WARNING!

Before using the insufflator to endoscopic harvest vessels, please check whether the used instrument is intended for CO₂ insufflation.



WARNING!

Pneumoperitoneum

When a vessel is harvested from the leg of a patient with a perforated groin, it is possible for CO₂ to reach the abdomen and cause a pneumoperitoneum. Make sure the abdomen does not fill with CO₂ during surgery.



WARNING!

Idiosyncratic reactions

Patients with sickle cell anemia or pulmonary insufficiency may have a higher risk of metabolic imbalance related to excessive CO₂ absorption (idiosyncratic reaction).



WARNING!

CO₂ absorption

Due to the special surgical procedures - start of the heart bypass operation, and the endoscopic removal of the vessel - special care has to be taken as CO₂ is always absorbed through the tissue of the patient during insufflation (intravasation). This means the body absorbs part of the CO₂ gas used for insufflation. CO₂ concentrations in the blood or respiratory system that are too high can lead to death of the patient in extreme cases. To lower this risk, always carefully and closely monitor the patient's vital signs during the entire insufflation process and make sure patient is breathing well. Sufficient respiration can help avoid or limit problems with CO₂. High pressure or a high gas flow promotes CO₂ absorption.



WARNING!

Metabolic and cardiac reactions

Due to the special surgical conditions - start of the heart bypass surgery and vessel harvesting - it is especially important to remember the existing risk of metabolic acidosis when insufflating with CO₂. This can lead to cardiac irregularities



EN

expressed with the following symptoms:

- Reduced respiration with restricted diaphragm function
- Hypercapnia
- Reduction of venous reflux
- Reduced cardiac output
- Metabolic acidosis



WARNING!

Dehydration

Insufflation can lead to dehydration of the tissue. This can result in organ tissue damage and cardiovascular reactions of the patient. Long surgeries and large leaks increase the risk of dehydration (especially at the insertion points of the trocars or when changing instruments).



WARNING!

Embolism

Improper placement of the insufflation instrument could cause insufflation of gas into a vessel, resulting in air or CO2 embolisms. To reduce the risk of air or CO2 embolism, perform initial insufflation at a low flow rate and ensure that the insufflation instrument is correctly positioned. Check the position of the insufflation instrument immediately if the actual pressure rapidly reaches the nominal pressure value. CO2 embolisms can also be caused by a high pressure. Avoid high-pressure settings and close damaged blood vessels at once.



WARNING!

Device-inherent dangers

Please read the general risks and dangers information in chapter 2.1 Hazards, page 5 and chapter 3.3 General Device-Inherent Dangers, page 8.

9.2 Selecting Vessel Harvest Operating Mode

1. Selection of the insufflation mode can be done only while insufflation is stopped. If Vessel Harvest operating mode is not yet set and displayed, press the function field **Change Mode** for 2 seconds to get the insufflation mode overview.
2. The display depicts an insufflation modes overview. Select the desired insufflation operating mode by pressing the **Vessel Harvest** function field.
3. The procedure profile is depicted on the display. The displayed parameters correspond with the factory settings or the values set in the Configuration menu (see chapter 10.1 Configuration menu I, page 60).

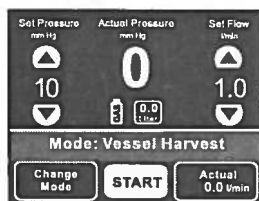
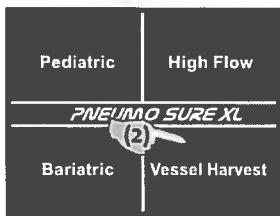
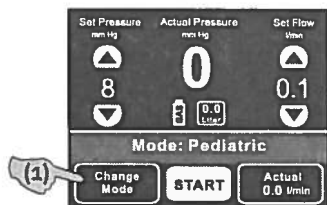

9.3 Presetting Nominal Pressure in Vessel Harvest Operating Mode

The nominal pressure can be set during insufflation or while insufflation is stopped. Values may range from 1 to max. 20 mm Hg or the value set in the Configuration menu.

Increasing/decreasing nominal pressure:

Briefly press the ▲ or ▼ function field to increase or decrease the pressure. Keeping the ▲ or ▼ function field depressed longer than 1.5 seconds activates scrolling in increments of 1.

Safety limit:

When **increasing** the nominal pressure, the status line of the display depicts **Safety limit** starting at 12 mm Hg and the nominal value flashes.

The nominal pressure value **12 mm Hg** is a limit value and should not be exceeded when performing vessel harvesting surgery. Pressing the nominal pressure ▲ function field again does not increase the pressure any further.

CAUTION!

Exceeding this safety limit is to be decided by and the responsibility of the user/operator.

Release the function field at that point. The display switches back to the nominal value setting after 2 seconds. Now you can set a value up to 15 mm Hg.

The **Safety limit** message is re-displayed in the status line starting at 15 mm Hg and the nominal value flashes.

The nominal pressure value **15 mm Hg** is a limit value and should not be exceeded when performing vessel harvesting surgery. Pressing the nominal pressure ▲ function field again does not increase the pressure any further.

CAUTION!

Exceeding this safety limit is to be decided by and the responsibility of the user/operator.

Release the function field at that point. The display switches back to the nominal value setting after 2 seconds. Now you can set a value up to 20 mm Hg.

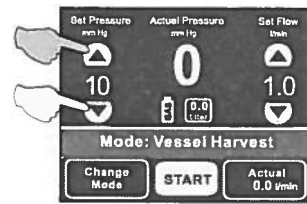

EN

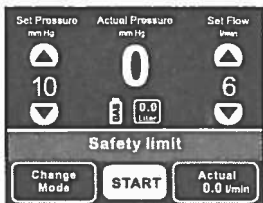
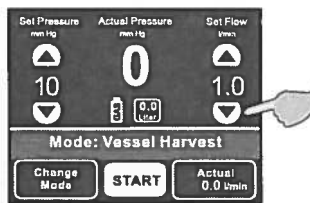
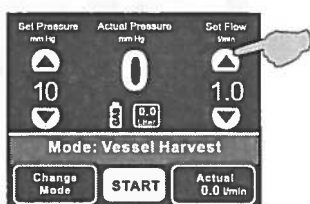

Preparation



9.4 Presetting Nominal Flow in Vessel Harvest Operating Mode

The nominal flow can be set during insufflation or while insufflation is stopped.

Increasing nominal gas flow:

- Press the function field ▲ to increase gas flow. The nominal flow can be increased from 1 to max. 10 l/min.
- Briefly press the corresponding function field to set values in increments of 0.5 for a range from 1 to 5 l/min.
- Set values in increments of 1 for a range from 5 to 10 l/min.
- Keeping the ▲ or ▼ function field pressed longer than 1.5 seconds activates scrolling through the gas flow rates 1, 4, 10 l/min (in the Configuration menu).

Reducing nominal gas flow:

Briefly press the nominal gas flow function field ▼ to reduce the nominal gas flow.

Safety limit:

The safety limit can be activated or deactivated in the Configuration menu.

When increasing the nominal flow, the status line of the display depicts **Safety limit** starting at 6 l/min and the nominal value flashes.

Release the function field to increase the nominal gas flow further. The display switches back to the nominal value setting after 2 seconds. Now you can set a value of up to 10 l/min.

CAUTION!

Exceeding this safety limit is to be decided by and the responsibility of the user/operator.

9.5 Performing the Function Test in Vessel Harvest Operating Mode before Using the Device during Surgery

Sterilize reusable instruments and tubing before surgery to prevent infections. Check all the single-use/disposable items before removing them from the package to ensure that the packaging is intact and that the expiration date is still valid.

For your own safety and that of your patient, use only original accessories.

WARNING!

The function test must be performed prior to each surgical procedure.

Testing the device

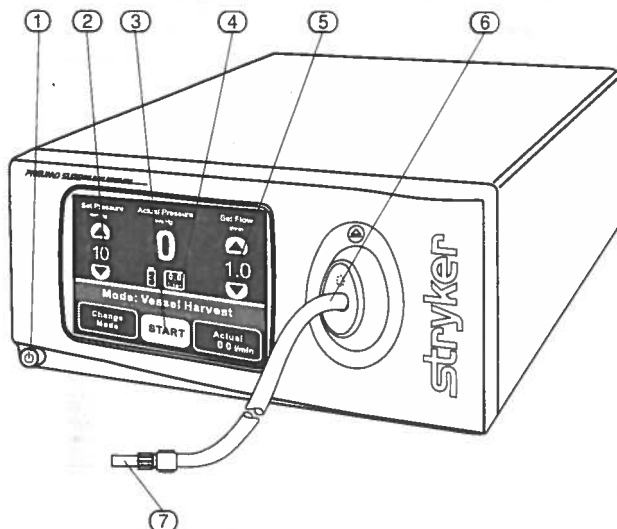

Fig. 9-1 Layout for testing the device

- ① ON/OFF switch
- ② Nominal pressure display
- ③ START/STOP function field
- ④ Gas consumption display
- ⑤ Nominal flow display
- ⑥ Insufflation tube set
- ⑦ Luer Lock connection

1. The device is switched off, no tube set is connected.
2. Make sure the gas supply is connected and open.
3. Use the ON/OFF switch ① to turn the device on. The device conducts a device check.
4. Select Vessel Harvest operating mode in the insufflation mode selection.
5. Connect an original insufflation tube set **High Flow 2** ⑥ to the device.
6. Press the function field for the gas consumption display ④ to set the display to **0 Liter**.
7. Select the nominal pressure 10 mm Hg ② and the gas flow 1 l/min ⑤.
8. Close the end of the tube (Luer Lock) ⑦.
9. Start insufflation: Press the **START** function field ③.
10. Insufflate for approx. 30 s. The display status line depicts **Occlusion** after max. 4 seconds.
11. Stop insufflation: Press the **STOP** function field ③.

WARNING!

If the actual gas consumption is higher than 0.4 l, there is a leak in the system.



12. Replace the tube set and repeat the test from step 6 to step 11.
13. If another leak is detected, this leak is then directly within the device. Make sure the device can no longer be operated until a qualified service technician conducts the appropriate tests and repairs.

WARNING!

Never work with a leaky insufflation tube, accessory, and/or device. This can lead to an incorrect measurement of the actual pressure values, which can cause an uncontrolled pressure increase in the abdomen.



The functionality of the gas heating is indicated by displaying the gas heating symbol on the display when using the "Heated tube set with RTP for Pneumo Sure".

Testing gas heating functionality

9.5.1 Filling Tube System with CO2

At least 1 l of CO2 has to be let out from the system before every surgery while the tube is connected and the end of the tube is open. This will expel any air within the tube system and the device.

EN

1. Start insufflation: Press the **START** function field.
Wait until the gas consumption display shows **1.0 Liter**.
2. Stop insufflation: Press the **STOP** function field.
3. Press the gas consumption display field to reset the gas consumption display to **0.0 Liter**. This ensures the gas consumption is correctly displayed during surgery.

The function test is complete. The device is tested and ready to be used for surgery.

**WARNING!**

Do not use this device if a defect is suspected or detected during the function check. This also applies to obvious defects, especially defects on the power plug and power cable.

Using the device during surgery



9.6 Using the Device during Surgery

WARNING!

The function test must be performed prior to each surgery.

**CAUTION!**

The venting system is automatically triggered (only if activated in the Configuration menu) if the measured actual pressure exceeds the set nominal pressure during insufflation. The device interrupts insufflation and releases gas until the actual pressure has dropped below the set nominal value.

1. The device is turned on.
2. An insufflation tube set is connected.



9.6.1 Insufflation with Vessel Harvest Instrument

Set the Vessel Harvest operating mode in the Configuration menu for an endoscopic vessel harvesting procedure. If the device was switched off during a vessel harvesting procedure, the display depicts **Vessel Harvest** after restarting the device indicating that the device is already using the Vessel Harvest mode.

CAUTION!

Before you use the insufflator for a vessel harvesting procedure, make sure to read the manual of your endoscopic instrument to check whether the instrument can be used in conjunction with CO₂.

1. Connect the special vessel harvesting instrument with the insufflation tube. Use a manufacturer's recommended instrument to harvest vessels.
2. Select the necessary nominal pressure and nominal gas flow.
3. Connect the Luer Lock connection of the insufflation tube to the vessel harvesting instrument.
4. Select the desired pressure and desired gas flow as intraoperative conditions.
5. Start insufflation: Press the **START** function field. Check the actual pressure display and the gas consumption display.
6. The actual pressure display shows the current measured value for insufflation. As soon as this value approximates the selected nominal value, the gas flow is automatically minimized. The gas consumption display shows the volume of gas consumed.
7. Check how the patient's body reacts to the selected pressure and gas flow rate. You can change the nominal gas flow and the nominal pressure during surgery without interrupting the insufflation process.

9.6.2 Stop the Insufflation

1. Press the **STOP** function field. The following values are displayed:
 - Gas consumption display: last measured value
 - Actual pressure: current measured value
 - Actual gas flow: 0 l/min
 - Nominal pressure: last set value In case of exceeding the safety limit, the nominal pressure value will be reset to the safety limit value.
 - Nominal gas flow: last set value In case of exceeding the safety limit, the nominal flow value will be reset to the safety limit value (only if activated).The status field of the display depicts **Insufflation stopped** followed by **Mode: Vessel Harvest** alternating with **Push  to release**.
2. Remove the tube set from the device. Observe applicable hygiene regulations when disposing of the tube set.

CAUTION!

If the tube set remains connected to the device, there is the danger that leftover fluid in the tube or the instruments will be sucked into the device.



-
3. Close the gas supply.
 4. Use the ON/OFF switch to turn the device off.

NOTE!

Observe applicable hygiene regulations when disposing of the tube set.



NOTE!

Insufflation with "Real-Time Pressure Sensing" (RTP) is not available in the Vessel Harvest operating mode.



EN

Configuration menu

10 Configuration Menu (Overview)

Device parameters are changed with the configuration menu. The following is an overview and a subsequent detail depiction (factory settings = **bold, italics**).

Configuration menu I						
Menu level	↔	1. Submenu level		2. Submenu level		3. Submenu level
First nominal pressure ↑↓		High Flow: 15 mm Hg (setting range 1-15 mm Hg)				
		Bariatric: 15 mm Hg (setting range 1-15 mm Hg)				
		Vessel Harvest 10 mm Hg (setting range 1-12 mm Hg)				
		Pediatric: 8 mm Hg (setting range 1-12 mm Hg)				
Venting controls ↑↓	↔	Venting valve status	↔	High Flow:*		
			↔	With veress insufflation OFF Venting system OFF		
			↔	Bariatric:*		
			↔	With veress insufflation OFF Venting system OFF		
			↔	Vessel Harvest:*		
			↔	Venting system ON Venting system OFF		
			↔	Pediatric:*		
			↔	With veress insufflation ON With veress insufflation OFF Venting system OFF		
	↔	Venting pressure limit	↔	2 mm Hg, 3 mm Hg , 4 mm Hg, 5 mm Hg		
	↔	Venting response time	↔	2 s, 3 s , 4 s, 5 s		
Gas supply ↑↓	↔	House gas Gas bottle				
Alarm volume ↑↓	↔	Level 1 Level 2 Level 3				

*Inactive menu items are displayed in gray.

Configuration menu II			
Menu level		1. Submenu level	2. Submenu level 3. Submenu level
Gas flow rate* ↑↓	↔	High Flow: Rate 1= 3 l/min (range 1-20) Rate 2= 20 l/min (range rate 1-40) Rate 3= 40 l/min (range rate 2-40)	
Venting controls ↑↓	↔	Bariatric: Rate 1= 5 l/min (range 1-20) Rate 2= 25 l/min (range rate 1-45) Rate 3= 45 l/min (range rate 2-45)	
	↔	Vessel Harvest: Rate 1= 1 l/min (range 1-10) Rate 2= 4 l/min (range rate 1-10) Rate 3= 10 l/min (range rate 2-10)	
First nominal gas flow	↔	Pediatric: 0.1 l/min (setting range 0.1-1 l/min)	
Max. nominal pressure ↑↓	↔	High Flow: 30 mm Hg (setting range 5-30 mm Hg) Bariatric: 30 mm Hg (setting range 5-30 mm Hg) Vessel Harvest: 20 mm Hg (setting range 5-20 mm Hg) Pediatric: 20 mm Hg (setting range 5-20 mm Hg)	
Flow safety limit	↔ ↔	Limit ON Limit OFF	
Warning signal Occlusion ↑↓	↔	Vessel Harvest: Signal ON, Signal OFF Bariatric: Signal ON, Signal OFF Pediatric: Signal ON, Signal OFF High Flow: Signal ON, Signal OFF	
<p>*Inactive menu items are displayed in gray.</p> <p>Menu item Gas Flow Rates is inactive in Pediatric mode.</p> <p>Menu item First Nominal Gas Flow is active exclusively in Pediatric mode.</p> <p>Menu item Flow Safety Limit is active only in Pediatric operating mode and Vessel Harvest operating mode.</p>			

EN

Utility menu						
Menu level	↔	1. Submenu level		2. Submenu level	3. Submenu level	
Display setting ↑↓		Dimmer		-75%, -50%, -25%		
		Dimmer sensor		Activated OFF		
Language ↑↓	↔	english	↔	nederlands	↔	polski
		français		norsk		română
		deutsch		suomi		simplified chinese
		español		greek		korean
		português		svenska		japanese
italiano	dansk					
Program version ↑↓	↔					
Upgrade XL		Upgrade from version Pneumo Sure to Pneumo Sure XL				
Service		Access only for service technicians				

*Inactive menu items are displayed in gray.

10.1 Configuration menu I

Functions of the configuration menu

While insufflation is stopped, press the **Actual** gas flow function field for 2 seconds to access the Configuration menu I

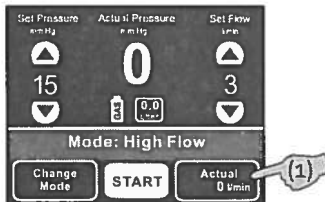

Depiction/functions in configuration menu	
	Tap the "arrow forward" function field to access the next menu on the same level.
	Tap the "arrow backward" function field to access the previous menu on the same level without saving settings or to access the previous menu of the next higher menu level.
	Tap the (SAVE) function field to save settings. The display depicts (SAVED) for 2 seconds. After saving you return automatically to the previous level.
	Press the (EXIT) function field to exit the menu or return to the work screen.

10.1.1 Setting First Nominal Pressure

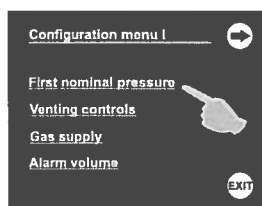

Operating mode	Factory setting	Range
Bariatric	15 mm Hg	1-15 mm Hg
High Flow	15 mm Hg	1-15 mm Hg
Vessel Harvest	10 mm Hg	1-12 mm Hg
Pediatric	8 mm Hg	1-12 mm Hg

In the configuration menu I, press the **First nominal pressure** function field to access the setting.

The display switches to the First nominal pressure menu.

Press the function field ▲ or ▼ to set the **First nominal pressure**.

You now have the opportunity to

1. save the selected value by pressing the **(SAVE)** function field. The display depicts **(SAVED)** for 2 seconds. After saving you return automatically to the previous level,
2. press the ⇐ function field to return to the previous menu level without saving,
3. or press **(EXIT)** to return to the work screen without saving.

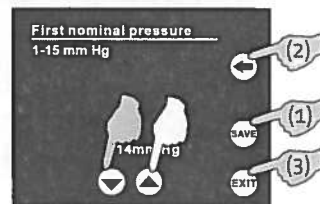

10.1.2 Setting the Venting Controls

In the configuration menu I, press the **Venting controls** function field to access the venting system selection.

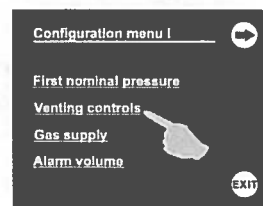

The display switches to the **Venting controls** selection menu.

Factory Settings

Operating mode	Factory setting	Range
Bariatric	With veress insufflation OFF	With veress insufflation OFF, Venting system OFF
High Flow	With veress insufflation OFF	With veress insufflation OFF, Venting system OFF
Vessel Harvest	Venting system OFF	Venting system ON, Venting system OFF
Pediatric	With veress insufflation ON	With Veress insufflation ON, With Veress insufflation OFF, Venting system OFF

Setting the venting valve status

For example, tap the **Venting valve status** function field.

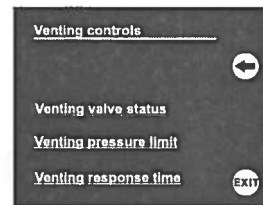

The display switches to the **Venting valve status** selection menu.

With Veress Insufflation ON is only selectable while in Pediatric operating mode and is otherwise depicted in gray.

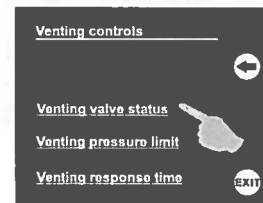

Venting system ON is only selectable while in Vessel Harvest mode and is otherwise depicted in gray.

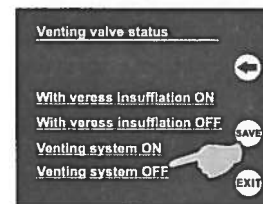

EN

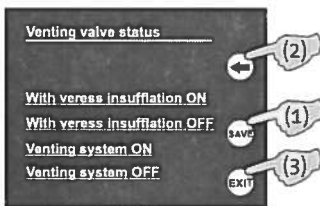

For example, press the **Venting system OFF** function field.

You now have the opportunity to

1. save the selected value by pressing the **(SAVE)** function field. The display depicts **(SAVED)** for 2 seconds. After saving you return automatically to the previous level,
2. press the **←** function field to return to the previous menu level without saving,
3. or press **(EXIT)** to return to the work screen without saving.

Setting the venting pressure limit of the venting valve

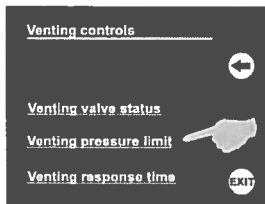

Factory setting = 3 mm Hg (for all operating modes)

For example, press the **Venting pressure limit** function field.

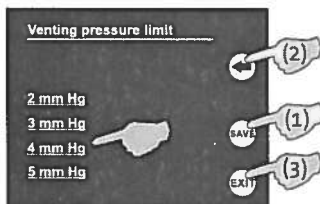

The display switches to the **Pressure limit** selection menu.

You now have the opportunity to

1. save the selected value by pressing the **(SAVE)** function field. The display depicts **(SAVED)** for 2 seconds. After saving you return automatically to the previous level,
2. press the **←** function field to return to the previous menu level without saving,
3. or press **(EXIT)** to return to the work screen without saving.

Setting the venting system response time

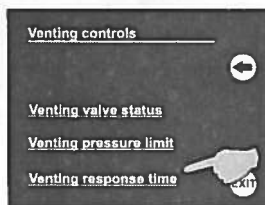

Factory setting = 3 s (for all operating modes)

For example, press the **Venting response time** function field.



The display switches to the **Venting response time** selection menu.

For example, press the **4 s** function field.

You now have the opportunity to

1. save the selected value by pressing the **(SAVE)** function field. The display depicts **(SAVED)** for 2 seconds. After saving you return automatically to the previous level,
2. press the **←** function field to return to the previous menu level without saving,
3. or press **(EXIT)** to return to the work screen without saving.

10.1.3 Setting the Gas Supply Type

Use this menu to select the type of connected gas supply.

Select **House Gas** if you are working with a house gas supply (use the corresponding house gas device adapter available as an additional accessory). The gas supply

indicators and displays are described in Chapter 11 Safety functions, page 70. If house gas supply has been selected but bottled gas (pressure >15 bar) is connected to the device, the gas supply display automatically switches accordingly.

Select **Bottle** if you want to work with a gas bottle. The gas supply indicators and displays are described in Chapter 11 Safety functions, page 70. It is not possible to operate the device if **Bottle gas** is set and a house gas supply is actually connected.

Factory setting = House gas

In the configuration menu I, press the **Gas supply** function field to access the gas supply selection menu.

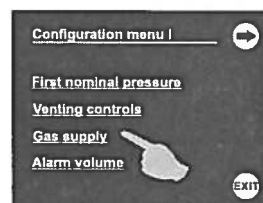

The display switches to the **Gas supply** selection menu.

You now have the opportunity to

1. save the selected value by pressing the **(SAVE)** function field. The display depicts **(SAVED)** for 2 seconds. After saving you return automatically to the previous level,
2. press the ← function field to return to the previous menu level without saving,
3. or press **(EXIT)** to return to the work screen without saving.



10.1.4 Setting the Alarm Volume

Factory setting = Level 3

In the configuration menu, press the **Alarm volume** function field to access the volume selection.

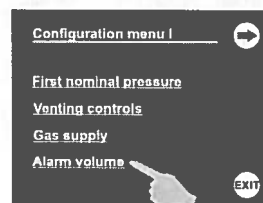

The display switches to the **Alarm volume** selection menu. The selection/setting applies to all operating modes.

For example, press the **Level 2** function field to lower the volume.

You now have the opportunity to

1. save the selected value by pressing the **(SAVE)** function field. The display depicts **(SAVED)** for 2 seconds. After saving you return automatically to the previous level,
2. press the ← function field to return to the previous menu level without saving,
3. or press **(EXIT)** to return to the work screen without saving.

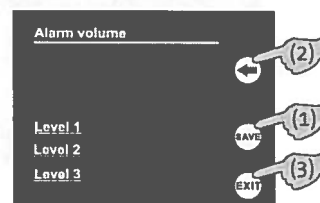
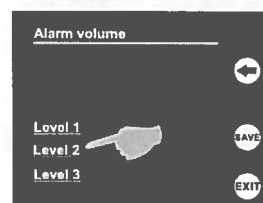

EN

Configuration menu II

10.2 Configuration menu II

While insufflation is stopped, press the **Actual** function field for 2 seconds to access the Configuration menu. In the Configuration menu I, press the ⇒ to access the Configuration menu II.

10.2.1 Setting the Gas Flow Rates*

Rate	Operating mode	Factory setting	Range
Rate 1	Bariatric	5 l/min	1 -20 l/min
	High Flow	3 l/min	1 -20 l/min
	Vessel Harvest	1 l/min	1 -10 l/min
	Pediatric	Not available	
Rate 2	Bariatric	25 l/min	Rate 1 -45 l/min
	High Flow	20 l/min	Rate 1 -40 l/min
	Vessel Harvest	4 l/min	Rate 1 -10 l/min
	Pediatric	Not available	
Rate 3	Bariatric	45 l/min	Rate 2 -45 l/min
	High Flow	40 l/min	Rate 2 -40 l/min
	Vessel Harvest	10 l/min	Rate 2 -10 l/min
	Pediatric	Not available	

*Inactive with Pediatric mode

In the configuration menu II, press the **Gas flow rates** function field to access the selection menu.

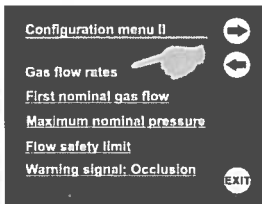

The display switches to the gas supply selection menu.

For example, press the function field (**Rate 1: 3 l/min**) to set gas flow rate 1.

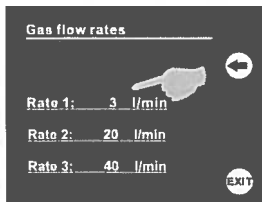

The display switches to the setting menu for gas flow rate 1.

Press the function field ▲ or ▼ to specify the value.

You now have the opportunity to

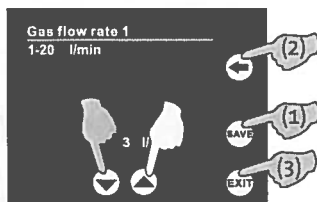

1. save the selected value by pressing the **(SAVE)** function field. The display depicts **(SAVED)** for 2 seconds. After saving you return automatically to the previous level,
2. press the ⇐ function field to return to the previous menu level without saving,
3. or press **(EXIT)** to return to the work screen without saving.

10.2.2 Setting First Nominal Gas Flow*

*Selectable only in Pediatric mode

In the Configuration menu I, press the ⇒ to access the Configuration menu II.

In the configuration menu II, tap the **First nominal gas flow** function field to access the setting.

Factory setting: **0.1 l/min** (0.1-1 l/min selectable)

The display switches to the **First nominal gas flow** menu.

Press the function field ▲ or ▼ to set the **First nominal gas flow**.

You now have the opportunity to

1. save the selected value by pressing the **(SAVE)** function field. The display depicts **(SAVED)** for 2 seconds. After saving you return automatically to the previous level,
2. press the ← function field to return to the previous menu level without saving,
3. or press **(EXIT)** to return to the work screen without saving.

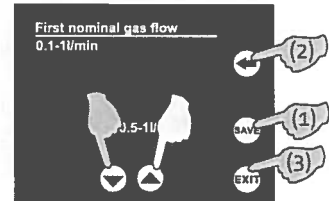
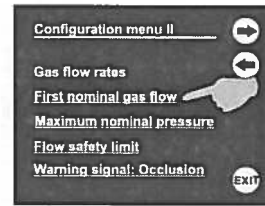

10.2.3 Setting the Maximum Nominal Pressure

Operating mode	Factory setting	Range
Bariatric	30 mm Hg	5-30 mm Hg
High Flow	30 mm Hg	5-30 mm Hg
Vessel Harvest	20 mm Hg	5-20 mm Hg
Pediatric	20 mm Hg	5-20 mm Hg

In the Configuration menu I, press the ⇒ to access the Configuration menu II.

The display changes to the Configuration menu II.

In the configuration menu, press the **Maximum nominal pressure** function field.

The display switches to the **Maximum nominal pressure** selection menu.

Press the function field ▲ or ▼ to specify the value.

You now have the opportunity to

1. save the selected value by pressing the **(SAVE)** function field. The display depicts **(SAVED)** for 2 seconds. After saving you return automatically to the previous level,
2. press the ← function field to return to the previous menu level without saving,
3. or press **(EXIT)** to return to the work screen without saving.

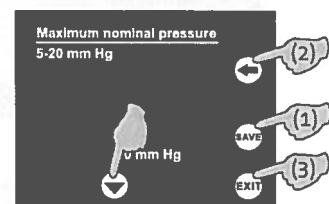
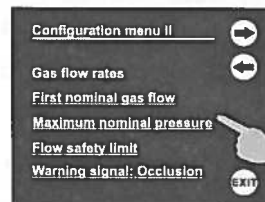
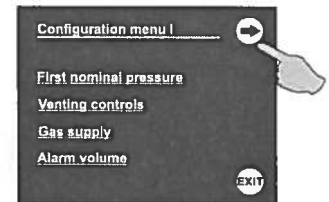

EN

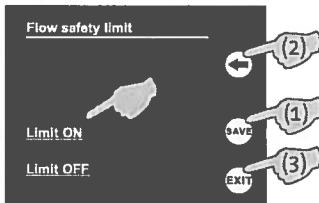
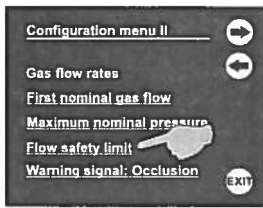

10.2.4 Setting the Flow Safety Limit*

Factory setting = Limit OFF

*selectable only in Pediatric operating mode and Vessel Harvest operating mode.

In the Configuration menu I, press the ⇒ to access the Configuration menu II.

In the configuration menu II, press the **Flow safety limit** function field to access the setting. (Only selectable while in Vessel Harvest or Pediatric operating mode; otherwise depicted in gray - if set, valid for both modes)

The display switches to the **Flow safety limit** selection menu.

For example, press the **Limit ON** function field.

You now have the opportunity to

- save the selected value by pressing the **(SAVE)** function field. The display depicts **(SAVED)** for 2 seconds. After saving you return automatically to the previous level,
- press the ⇐ function field to return to the previous menu level without saving,
- or press **(EXIT)** to return to the work screen without saving.

10.2.5 Setting the Warning signal: Occlusion

Factory Settings

Operating mode	Factory setting
Bariatric	Signal ON
High Flow	Signal ON
Vessel Harvest	Signal OFF
Pediatric	Signal ON

In the Configuration menu I, press the ⇒ to access the Configuration menu II.

The display changes to the Configuration menu II.

In the configuration menu II, press the **Warning signal: Occlusion** function field to access the selection menu.

The display switches to the **Warning signal: Occlusion** selection menu.

For example, press the **Signal OFF** function field.

You now have the opportunity to

1. save the selected value by pressing the **(SAVE)** function field. The display depicts **(SAVED)** for 2 seconds. After saving you return automatically to the previous level,
2. press the ⇐ function field to return to the previous menu level without saving,
3. or press **(EXIT)** to return to the work screen without saving.

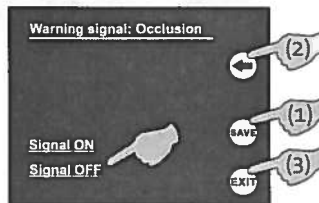
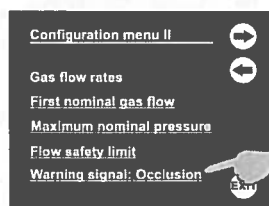
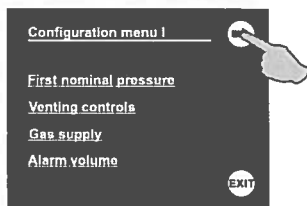

Utility menu

10.3 Utility menu

While insufflation is stopped, press the **Actual** function field for 2 seconds to access the Configuration menu. In the Configuration menu I, press the ⇒ function field to access the Configuration menu II and there press the ⇒ function field

again to access the Utility menu.

10.3.1 Changing Display Settings

Factory setting

	Factory setting
Dimmer	-75%
Dimmer sensor	Activated

In the Utility menu, press the **Display setting** function field to access the selection menu.

The display switches to the **Display setting** selection menu.

For example, press the **Dimmer** function field.

The display switches to the **Dimmer** selection menu.

Press the respective function field to set the dimming level (-75%/-50%/-25%).

You now have the opportunity to

1. save the selected value by pressing the **(SAVE)** function field. The display depicts **(SAVED)** for 2 seconds. After saving you return automatically to the previous level,
2. press the **←** function field to return to the previous menu level without saving,
3. or press **(EXIT)** to return to the work screen without saving.

The display switches to the **Display setting** selection menu.

For example, press the **Dimmer sensor** function field.

The display switches to the **Dimmer sensor** selection menu.

For example, press the **OFF** function field.

You now have the opportunity to

1. save the selected value by pressing the **(SAVE)** function field. The display depicts **(SAVED)** for 2 seconds. After saving you return automatically to the previous level,
2. press the **←** function field to return to the previous menu level without saving,
3. or press **(EXIT)** to return to the work screen without saving.

10.3.2 Setting the Language

While insufflation is stopped, press the **Actual** function field for 2 seconds to access the Configuration menu. In the Configuration menu I, press the **⇒** function field to access the Configuration menu II and there press the **⇒** function field again to access the Utility menu.

Factory setting = english

In the Utility menu, press the **Language** function field to access the language selection screen.

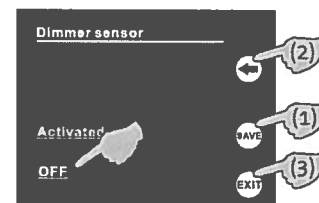
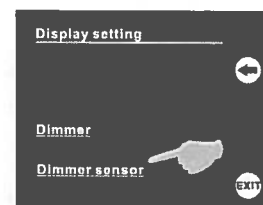
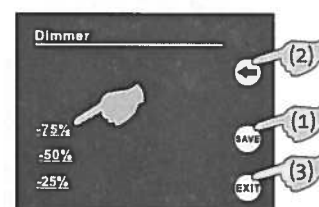
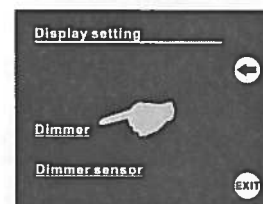
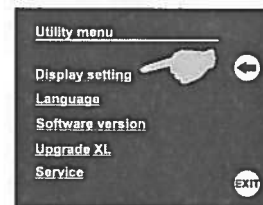

EN

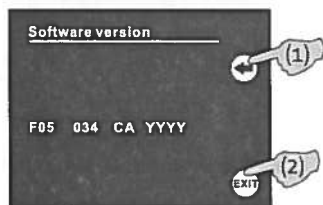
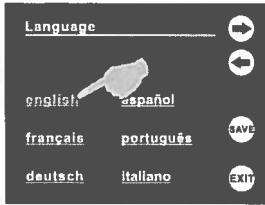
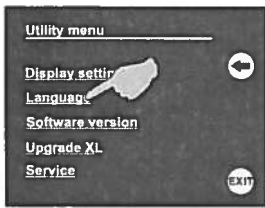

The following languages are available:

1. Submenu level	2. Submenu level	3. Submenu level
english	nederlands	polski
français	norsk	română
deutsch	suomi	simplified chinese
español	greek	korean
português	svenska	japanese
italiano	dansk	

Press the **english** function field to select english as the display language, for example.

You now have the opportunity to

1. save the selected value by pressing the **(SAVE)** function field. The display depicts **(SAVED)** for 2 seconds. After saving you return automatically to the previous level.
2. press the **←** function field to return to the previous menu level without saving.
3. or press **(EXIT)** to return to the work screen without saving.

10.3.3 Checking Software Version

In the Utility menu, press the **Software version** function field to open the corresponding window.

The display depicts the **Software version**.

You now have the opportunity to

1. press the **←** function field to return to the previous menu level without saving.
2. or press **(EXIT)** to return to the work screen without saving.

10.3.4 Upgrade XL*

*Only selectable for Pneumo Sure devices, inactive with Pneumo Sure XL devices

In the Configuration menu I and II press the ⇒ to access the Utility menu.

The display changes to the Utility menu.

In the Utility menu, press the **Upgrade XL** function field.

Press the function field ▲ or ▼ to specify the first digit of the activation code.

Save the first set digit by pressing the **(SAVE)** function field.

Press the function field ▲ or ▼ to specify the next digit of the activation code.

Save the set digit by pressing the **(SAVE)** function field.

Repeat this process until you have the complete activation code.

You now have the opportunity to

1. press the ⇐ function field to return to the previous menu level without saving,
2. or press **(EXIT)** to return to the work screen without saving.

10.3.5 Service Menu

Access to the service menu is restricted for trained and authorized service personnel. Please consult the service manual for further information.

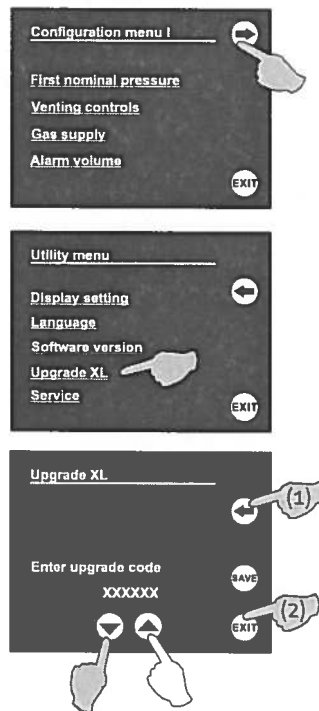

EN

Automatic venting system



Insufflation source

Exceeding nominal pressure

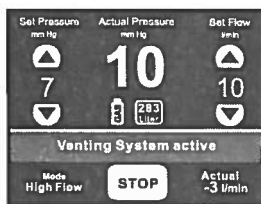

Exceeding nominal pressure for more than 5 seconds



Nominal pressure limit 30 mm Hg / 20 mm Hg

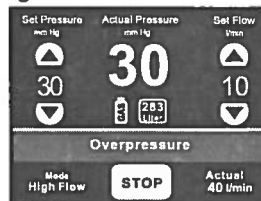

11 Safety functions

The device is equipped with an automatic venting system.

When the insufflator detects an overpressure it automatically activates the venting system. The venting system releases gas from the abdomen or from the vessel until the set nominal value has been reached again.

The function "Automatic venting system" can be activated/deactivated in the Configuration menu.

CAUTION!

Please note that the automatic venting system is only active during the Veress insufflation mode if "In Veress insufflation ON" has been set in the configuration menu (only possible in Pediatric operating mode, see chapter 7 Using and Controlling the PNEUMO SURE High Flow Insufflator in Pediatric Operating Mode, page 34).

WARNING!

The venting rate of the automatic venting system is limited. Always monitor the actual pressure when using additional insufflation sources.

The manufacturer advises against using additional, non-pressure controlled insufflation sources during minimally invasive surgical procedures.

The self-inflating property of lasers cooled with CO2 and argon beamers can lead to values exceeding the recommended and safe pressure rating.

After 2 to 5 seconds (depending on the setting in the Configuration menu), the display depicts **Venting system active** when the nominal pressure has been exceeded by 2-5 mm Hg.

If the overpressure cannot be reduced by the automatic venting system within 5 seconds, the display depicts **Overpressure** followed by **Venting system active**. An acoustic alarm is emitted.

Once the nominal pressure limit has been reached/exceeded (High Flow/Bariatric -> 30 mm Hg or Pediatric/Vessel Harvest -> 20 mm Hg), the display depicts the message **Overpressure**. A warning signal is emitted at the same time.

If the actual pressure reaches /exceeds nominal pressure +4 mm Hg longer than 3 seconds, the display depicts **Overpressure**.

In case of deactivated venting system or during Veress insufflation



The status of the gas supply is monitored by the device and indicated with symbols and acoustic signals.

Gas supply displays

The following gas bottle pressures are displayed:

Gas supply with gas bottle

	> 50 bar
	40 - 50 bar
	30 - 40 bar
	15 - 30 bar; Three warning signals can be heard and the message "Change gas tank" is displayed. User is advised to obtain a replacement tank.
	< 15 bar; Three warning signals can be heard and the message "Check gas supply" is displayed. Replace gas tank immediately.

If gas supply pressure declines further, there are warnings to remind the user to replace the gas tank immediately. Five warning signals can be heard and the message "Check gas supply" is displayed at < 5 bar and again at 0 bar. Insufflation stops at 0 bar.

House gas supply

The following house gas supply pressures are displayed:



House gas supply pressure OK



House gas supply pressure too low

When tube, Veress cannula, or trocar experience a temporary blockage, **Occlusion** is depicted. An audible warning signal is emitted. Actual pressure and actual flow displays show 0.

Warning message "Occlusion"

The acoustic message (warning signal) can be activated/deactivated in the configuration menu. In Pediatric mode < 1 l/min the warning signal is deactivated.

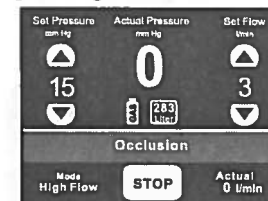

When fluid has penetrated the device via the insufflation tube connection, **Contamination** is displayed and 3 warning signals are emitted.

Error message "Contamination"

Message is repeated with each START/STOP.

EN

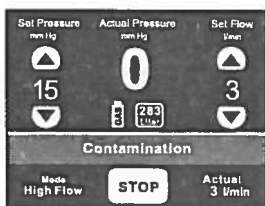

Contamination/Call service

It is possible to conclude the current surgery with this device. Insufflation is not possible after turning the device off and back on using the ON/OFF key. This is to prevent cross-contamination.

The display depicts **Contamination** alternating with **Call service** if you are switching on an already contaminated device. The device can no longer be used. The contaminated device has to be clearly marked as contaminated and sealed in two separate protective layers of safety foil. Make sure the device can no longer be used until a qualified service technician conducts the appropriate tests and repairs.

Error message when starting with defective venting valve

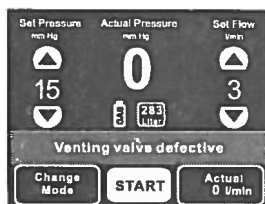

CAUTION!

The venting valve is no longer available to reduce high pressures after a problem with the venting valve has been detected.

With each START/STOP, a 3x warning signal and the message **Venting valve defective** are repeated.

It is still possible to use the device but pay special attention to the pressure values while this error persists. A service technician should check/repair the device after the completed surgery.

Error detection and monitoring of the "Real-Time Pressure Sensing (RTP)" function

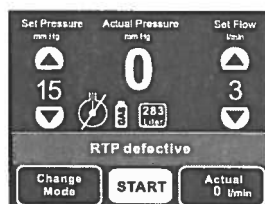

The function of the continuous pressure measurement is verified during the device check and while the device is operated.

If the device self-test yields an error of the continuous pressure measuring, the crossed out symbol for the continuous pressure measuring then depicted in the display  and the status line reads **RTP defective** followed by **Call service**. Three warning signals can be heard. Message is repeated with each START/STOP. Surgery can be continued but without the continuous pressure measurement. **Do not connect the measuring line of the RTP system with a trocar.**

After surgery is finished, call a service technician to repair the device.

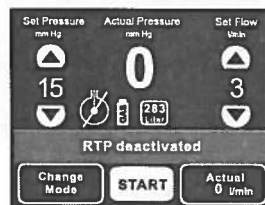

CAUTION!

The measuring line of the RTP system may not be connected to an open trocar if the error message "RTP defective," "Call service" is displayed. Remove the measuring line since a connected line may result in an unintended slow pressure increase within the abdomen.

The continuous pressure measurement can be activated only if the automatic device check is concluded successfully when switching on the device. If one or both tubes are occluded during the device check and/or pressure is applied, the  symbol is depicted crossed out and the status line reads as follows: **RTP deactivated**. Three warning signals can be heard. Message is repeated with each START/STOP. Surgery can be continued but without the continuous pressure measurement.

NOTE!

Please make sure that neither of the two tubes is connected to a trocar or closed off during a device check. The continuous pressure measurement cannot be activated otherwise.



EN

If the power fails for less than 1 second, all settings are retained. If the power fails for an extended time period, the device will function as it does when it is being restarted.

Power failure

If a device malfunction occurs that prohibits any further use of the device or diminished its safety, the display depicts only

Text message - >Call service

The following text messages may be displayed:

- **Contamination**
- **Electronic defective**
- **Sensor defective**
- **Venting valve defective**
- **Calibration error**
- **Temperature error**

Make sure the device can no longer be operated until a qualified service technician conducts the appropriate tests and repairs.

12 Care and Maintenance

Special care is necessary when servicing, maintaining, and storing the device and its accessories to maintain the functionality of the device and its accessories.

12.1 Cleaning the Device

1. Use the On/Off key to turn the device off.
2. Remove the power cable.
3. Wipe the surface of the device with a soft cloth moistened with the surface disinfectant (for example Meliseptol® rapid). The concentration of the used disinfectant depends on the information provided by the manufacturer of the disinfectant. Make sure moisture does not enter the device.

NOTE!

Do not sterilize the device.



Manufacturer's specifications

12.2 Annual Inspection

The manufacturer stipulates that qualified personnel or hospital technicians must regularly test the device to assess its functionality and technical safety. This inspection has to be carried out once a year. The tests are described in chapter 12 Care and Maintenance.

Regular inspections will assist in early detection of possible malfunctions. This helps preserve the device and increases its safety and service life.

Two-year maintenance interval

12.3 Maintenance by Authorized Service Technician

An authorized service technician has to inspect and service the device at appropriate intervals to ensure the safety and functionality of the unit. The minimum service interval is two years, depending on frequency and duration of use. If the service interval is not maintained, the manufacturer does not assume any liability for the functional safety of the device.

A sticker located on the rear panel of the device will remind you of the latest date for the next service or maintenance check.

Authorized service technicians are only trained and certified by the manufacturer.

Authorized trained personnel

All of the service tasks, such as changes, modifications, repairs, calibrations, etc. may be carried out only by the manufacturer or manufacturer-approved trained and skilled technicians.

Unauthorized personnel

The manufacturer is not liable for the operational safety of the device if unauthorized persons conduct this maintenance or any other service tasks.

Liability

Unauthorized opening of the device and repairs performed by unauthorized personnel or third parties and/or changes or modifications release the manufacturer of any liability concerning the operational safety of the device.

Technical documents

Receiving technical documentation from the manufacturer does not authorize individuals to perform repairs, adjustments, or alterations on the device or accessories/peripherals.

Certification

Ask the service technician for a certificate after he or she has inspected the unit or performed any service tasks. This certificate lists the type and scope of the service as well as the date and name of the servicing company together with the signature of the service technician.

12.4 Replacing the Fuse

CAUTION!

Before replacing the fuse, check the values of the fuse to be inserted acc. to chapter 16 Technical Data, page 89.



The fuse may be defective and is in need of replacement if:

- displays and LEDs do not light up,
- the device does not function.

Check to make sure

- the main power supply cable is properly connected to the power supply input and to a safety socket,
- the house power supply fuse is functioning.

WARNING!

Unplug the power cable from the device before checking the fuse.



The device does **not** have to be opened to replace the fuse.

1. Switch device off.
2. Disconnect device from power supply.
3. Remove power connection cable from mains socket.
4. The fuse holder is located to the left of the mains socket. Remove fuse holder as depicted in Fig. 12-1.

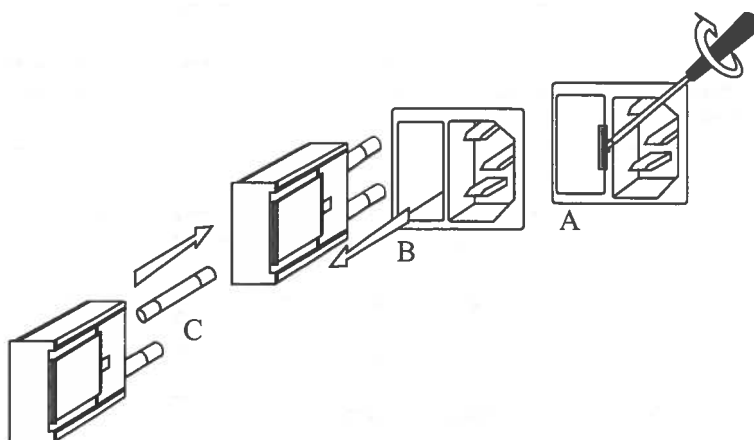

Fig. 12-1 Opening the fuse holder

5. **A** Undo the latch of the fuse holder with a small screwdriver.
6. **B** Remove the fuse holder.
7. **C** Check fuses.
8. Insert a new fuse. Use only the specified type of fuse (see chapter 16 Technical Data, page 89).
9. Insert the fuse holder until it can be heard snapping into place.
10. Use the power cable to reconnect the shockproof safety socket with the rear mains socket.

12.5 Care and Maintenance of Reusable Tube Set

The device can be used with reusable tube set with gas heating validated for this purpose. Please observe the following notices when using a reusable tube set.

EN

Notes about the Veress cannula

**12.5.1 Cleaning the Reusable Tube Set**

1. Dismantle the tubing set.
 2. Wash the parts carefully under running water.
 3. Clean and rinse the parts with demineralized water.
 4. Let all parts drip off and dry them with a sterilized soft cloth.
1. Before cleaning: Dismantle the Veress cannula (unscrew the insertion cannula from the insufflation cannula with stopcock open).
 2. Wash the parts carefully under running cold and warm water.
 3. Clean the inner chamber of the Veress cannula with a cleaning pistol.
 4. For disinfection, open the stopcock at the Veress cannula.

12.5.2 Disinfecting the Reusable Tube Set**WARNING!**

Disinfection of the tube and instruments is insufficient to achieve a sterility of SAL 10⁻⁶. Further sterilization is absolutely required after the disinfecting process.

CAUTION!

Do not place the plug of the reusable gas heating tube into the disinfectant solution. Should this happen once, ensure that the plug is thoroughly dried prior to sterilization.

1. Only a thoroughly cleaned tube set may be disinfected.
2. Place all tube set components into a disinfectant. The concentration and the application duration of the disinfectant depends on the information provided by the manufacturer of the disinfectant. The tube set can be damaged if the concentration is too high.

WARNING!

Do not leave tube set or other silicone parts in the solution for more than 30 minutes. Silicon absorbs various disinfectants and thus can be damaged when sterilized with steam.

3. Place the individual parts into the disinfection solution. Do not stack parts.
4. Remove the parts from the solution using forceps with a soft edge.
5. Remaining disinfection solution should be rinsed off with sterile water under sterile conditions.
6. Dry all parts with a sterile cloth and wrap each part in a separate sterile cloth.
7. Assemble all components before sterilization.
8. Place the tube set in a sterile container if stored for a longer period of time.

12.5.3 Sterilization of Reusable Tube Set

The maximum number of sterilization cycles for the tube set is determined by the manufacturer (see tube packaging). Never exceed the number of uses indicated by the manufacturer.

WARNING!

Use the tear-off tabs attached to the tube set to keep track of the number of sterilization cycles. The tube set may not be sterilized after the last tab has been removed.

WARNING!

Always check the reusable tube set for signs of deterioration before use and after sterilization. Never use a tube set which shows signs of deterioration, including

cracking, brittleness, or signs of perforation.

Only clean, dry, disinfected, and assembled tube sets should be sterilized in an autoclave. Please follow the instruction manual of the autoclave you are using.

Autoclave sterilization

The manufacturer recommends autoclaving as follows:

134 °C / 3 bar / 5 min

Only clean, dry, disinfected, and assembled tube sets should be sterilized. Please follow your gas sterilizer's instruction manual for proper use when using gas sterilization.

Gas sterilization

Do **not** perform gamma ray sterilization.

Gamma ray sterilization

Measured values and tolerances

13 Annual Inspection

Each test conducted has to be documented with date and signature on the test log.

The following measuring tools and resources were used by the manufacturer to determine the listed measurements and tolerances:

Manometer	Range 0-100 mm Hg, error class 1.6
Syringe	60 ml
Silicone tube	8 x 2 mm
T adapter	8-8-8 mm
Veress cannula	length 100 mm opening diameter 1.4 mm, inner cannula diameter 1.6 mm

An authorized service technician must check the device if the specified parameters and tolerances are exceeded.

13.1 Safety Test

1. Perform a visual inspection. Make sure that
 - the fuse corresponds with the specifications indicated by the manufacturer,
 - labels and stickers on device are legible,
 - the mechanical condition of the device allows for its safe use,
 - the device is clean to ensure proper and safe functionality.
2. Measure leakage currents according to IEC 60601-1 / EN 60601-1.
3. Measure protective conductor resistance according to IEC 60601-1 / EN 60601-1. The protective conductor resistance is measured while device is connected to the power supply. The max. value is 0.2 Ω.
4. Measure the insulation resistance with 500-700 V DC. The min. value is 50 MΩ. The electric strength with high voltage cannot be measured.

As an alternative, perform safety test according to IEC 62353 / EN 62353.

13.2 Basic Function Test (in High Flow Operating Mode)

1. Remove insufflation tube from device.
2. Use the On/Off switch to turn the device on. The device conducts a device check. A short signal can be heard. Set to High Flow operating mode.
3. The factory default settings are 15 mm Hg for the nominal pressure and 3 l/min for the nominal flow.
4. The following values are displayed:
 - Nominal pressure 15* [mm Hg]
 - Nominal gas flow 3* [l/min]
 - Actual pressure 0 [mm Hg]
 - Gas consumption 0.0 [l]

*These values correspond with the factory setting. If values in the configuration menu were changed, these changed values are displayed.
5. Start insufflation: Press the **START** function field. The following values are displayed:
 - Actual pressure 0 [mm Hg]

Veress insufflation is displayed. Streaming gas can be heard at the insufflation tube.
6. Select the max. nominal gas flow. The following values are displayed:
 - Nominal gas flow max. value [l/min]
 - Actual pressure 0 [mm Hg]

Insufflation: High Flow is displayed. Streaming gas can be heard at the insu-

flation tube.

7. Stop insufflation: Press the **STOP** function field.

The following values are displayed:

Actual pressure 0.0 [mm Hg]

Gas consumption >0.0 [l]

8. Press the gas volume function field.

Gas consumption >0.0 [l]

The basic function test of the device is complete.

13.3 Testing the Pressure Sensors in High Flow Operating Mode

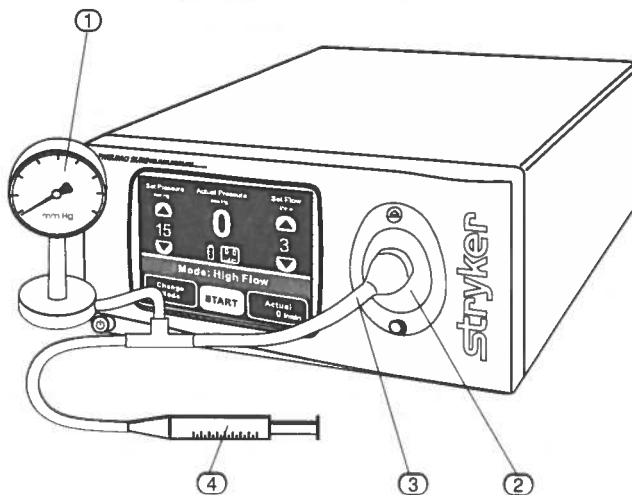

1. Set to High Flow operating mode.
2. Select a nominal gas flow rate of 1.0 l/min.
Do **not** press the **START/STOP** function field.

CAUTION!

Never use the syringe to extract gas from the device.



3. Connect a manometer (1) and an air-filled syringe (4) to the insufflation tube connection (3)/adapter (2).
4. Use the syringe to generate a pressure of at least 10 mm Hg, which registers on the manometer.
Actual pressure display: 10 ± 2 [mm Hg]
5. Use the syringe to generate a pressure of at least 20 mm Hg, which registers on the manometer.
Actual pressure display: 20 ± 2 [mm Hg]
6. Use the syringe to generate a pressure of at least 30 mm Hg, which registers on the manometer.
Actual pressure display: 30 ± 2 [mm Hg]

13.4 Pressure Monitoring Test in High Flow Operating Mode

See also 16 Technical Data, page 89.

1. Set to High Flow operating mode.
2. Select a nominal pressure of 15 mm Hg and a nominal gas flow of 3 l/min.
3. In the **Venting pressure limit** configuration menu, set a venting pressure of 3 mm Hg.
4. Use the syringe to generate a pressure of at least 19 mm Hg, which registers on the manometer. Start insufflation: Press the **START** function field. An acoustic warning sound is emitted with a pressure of more than 19 mm Hg (for 5 seconds) and the display depicts **Overpressure**.
5. Reduce the pressure. The warning ends when the pressure falls below 19 mm Hg (nominal pressure plus 4 mm Hg). Stop insufflation: Press the **STOP** function field.
6. Use the syringe to generate a pressure of at least 30 mm Hg, which registers on the manometer. Start insufflation: Press the **START** function field. An acoustic warning sound is emitted without delay in case pressure exceeds 30 mm Hg and the display depicts **Overpressure**.
7. Reduce the pressure. The warning ends when the pressure falls below 30 mm Hg. Stop insufflation: Press the **STOP** function field.

13.5 Venting Valve Test

See also 13.3 Testing the Pressure Sensors in High Flow Operating Mode, page 79.

1. In the **Venting System** configuration menu, activate the venting system (when **Veress insufflation OFF** is set).
2. In the **Venting response time** configuration menu, set a venting time of 3 seconds.
3. In the **Venting pressure limit** configuration menu, set a venting pressure of 3 mm Hg.
4. Select a nominal pressure of 15 mm Hg and a nominal gas flow of 10 l/min.
5. Use the syringe to generate a pressure of at least 18 mm Hg, which registers on the manometer. Start insufflation. The venting valve is activated and the display depicts **Venting system active** if pressure exceeds 18 mm Hg (for 3 seconds).

13.6 Max. Device Pressure Test

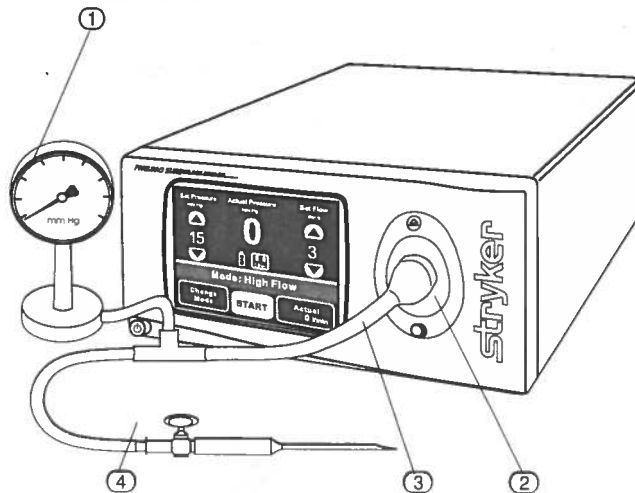

1. Set to High Flow operating mode (Pneumo Sure XL: Set to Bariatric operating mode).
2. Select the max. nominal gas flow.
3. Connect a manometer (1) and an open Veress cannula (4) to the insufflation tube connection (3)/adapter (2).
4. Select the max. gas flow.
5. Start insufflation:
Press the **START** function field. The manometer registers a pulsing pressure increase. When the pressure stabilizes, the manometer registers a maximum pressure of 55-65 mm Hg (Bariatric: 65-75 mm Hg).
6. Stop insufflation:
Press the **STOP** function field.

13.7 Gas Flow Rate Test

Test setup with open connection, without connected insufflation tube.

- Select a nominal gas flow rate of 15 l/min.
- Start insufflation:
Press the **START** function field.
- Press the gas volume function field (0.0 l must be displayed).
Now start measuring for one minute.
- Stop the insufflation after one minute: Press the **STOP** function field.
The gas consumption should be at least 11-12 l.

Each successfully conducted test must be documented with the test log.

EN

Precautionary measures**14 Electromagnetic compatibility**

Medical devices are subject to special precautionary measures concerning electromagnetic compatibility (hereafter abbreviated as EMC).

Medical devices are subject to special safety and protective measures concerning electromagnetic compatibility (hereafter abbreviated as EMC). This device is to be used only for the purposes described in the manual and has to be installed, set up, and operated in compliance with the EMC notes and instructions.

14.1 Impact of Mobile and Portable HF Communication Devices

The emission of high frequency energy by mobile communication devices may impact the function of the electrical medical device. Operating such devices (e.g., cell phones, GPS phones) in the proximity of the electrical medical device is prohibited.

14.2 Electrical Connections

Do not touch electrical connections identified with this warning label. Do not establish a connection between these plugs and sockets without first implementing precautionary ESD (electrostatic discharge) measures.

ESD (Electrostatic Discharge) precautionary measures

The following are ESD precautionary measures:

- Apply potential equalization (PE), if available on your equipment, to all devices to be connected.
- Use only the listed equipment and accessories.

Employees have to be informed about and trained in ESD precautionary measures.

14.3 Accessories**Data transfer**

An RS 232 serial cable can be connected to the PNEUMO SURE High Flow Insufflator. This cable is used to transfer data to/from an external computer (max. cable length = 3.0 m).

Gas heating

An insufflation tube with gas heating can be connected to the PNEUMO SURE High Flow Insufflator.

14.4 Guidelines and Manufacturer's Statement - Electromagnetic Interference Immunity

The device PNEUMO SURE High Flow Insufflator is intended for use in the electromagnetic environment specified below. The customer or operator of the device should make sure the device is operated within such an environment.

Electromagnetic interference immunity tests	Test level	Compliance	Electromagnetic environment guidelines
Discharge of static electricity (ESD) according to IEC 61000-4-2	± 6 kV contact discharge, ± 8 kV air discharge	In compliance	Floors should be made from wood or concrete or covered with ceramic tiles. If the floor covering consists of synthetic material, the relative humidity should be at least 30%.
Electrical fast transients / bursts according to IEC 61000-4-4	± 2 kV for power lines, ± 1 kV for input and output lines.	In compliance	The quality of the supply voltage should be the same as the voltage of a typical business or hospital environment.
Surges according to IEC 61000-4-5	± 1 kV normal mode voltage, ± 2 kV common mode voltage	In compliance	The quality of the supply voltage should be the same as the voltage of a typical business or hospital environment.
Blackouts, brown-outs, and fluctuations of the power supply according to IEC 61000-4-11	< 5% UT* (> 95% crash of the UT) for ½ period	In compliance	The quality of the supply voltage should be the same as the voltage of a typical business or hospital environment. If the user/operator of device requires the continuation of functionality after power interruptions/disruptions, it is recommended to supply the device with power from an uninterruptable power supply.
	40% UT (60% crash of the UT) for 5 periods		
	70% UT (30% crash of the UT) for 25 periods		
	< 5% UT (> 95% crash of the UT) for 5 s		
Supply frequency magnetic field (50/60 Hz) according to IEC 61000-4-8	3 A/m	In compliance	Magnetic fields of the mains power frequency should comply with the typical values of business and hospital environments.

*Note: UT is the mains alternating voltage before applying the test levels.

14.5 Guidelines and Manufacturer's Statement – Electromagnetic Emissions

The device PNEUMO SURE High Flow Insufflator is intended for use in the electromagnetic environment specified below. The user/operator of the insufflator should make sure the device is operated within such an environment.

Emitted interference measurements	Compliance	Electromagnetic environment guidelines
HF emission according to CISPR 11	Group 1	The PNEUMO SURE High Flow Insufflator uses HF energy only for its internal functions. Therefore, the device's HF emission is very low and it is unlikely that devices in close proximity will experience interference.
HF emission according to CISPR 11	Class B	The PNEUMO SURE High Flow Insufflator is suitable for use in all facilities including those in residential areas and those directly connected to a public utility network also supplying buildings used for residential purposes.
Emission of harmonic oscillations according to IEC 61000-3-2	Class B	
Emission of voltage fluctuations / flickers according to IEC 61000-3-3	In compliance	

14.6 Guidelines and Manufacturer's Statement - Electromagnetic Interference Immunity - PNEUMO SURE High Flow Insufflator

The device PNEUMO SURE High Flow Insufflator is intended for use in the electromagnetic environment specified below. The user/operator of the insufflator should make sure the device is operated within such an environment.

Electromagnetic interference immunity tests	Test level	Compliance	Electromagnetic environment guidelines
<p>Conducted HF interference quantities according to IEC 61000-4-6</p> <p>Radiated HF interference quantities according to IEC 61000-4-3</p>	<p>3 Veff 150 KHz to 80 MHz</p> <p>3 V/m 80 MHz to 2.5 GHz</p>	<p>In compliance</p>	<p>Portable and mobile wireless devices should not be used in closer proximity to the device (including cables/lines) than the recommended safety distance calculated based on the transmitting frequency of the applicable formula. Recommended safety distance:</p> <p>$d = 1.2\sqrt{P}$ for 150 KHz to 80 MHz; $d = 1.2\sqrt{P}$ for 80 MHz to 800 MHz; $d = 2.3\sqrt{P}$ for 800 MHz to 2.5 GHz</p> <p>With P as the rated output of the transmitter in watts [W] according to the information provided by the manufacturer of the transmitter and d as recommended safety distance in meters [m].</p> <p>The field strength of stationary transmitters for all frequencies tested on site ^a should be lower than the concordance level. ^b</p> <p>Interference is possible in the proximity of devices featuring the following pictograph.</p> 

Note 1: The higher frequency range applies for 80 and 800 MHz.

Note 2: These guidelines are probably not realizable in all cases. The distribution and spread of electromagnetic quantities differs depending on the absorption and reflection of buildings, objects, and people.

^a The field strength of stationary transmitters such as base stations of wireless phones and cell phones, ham radio operators, AM and FM radio and TV stations can theoretically not always determined in advance. A study of the installation site should be considered to determine the electromagnetic environment concerning the stationary transmitter. If the field strength measured at the usage

site of the device exceeds the compliance levels listed above, the device should be monitored for proper function. If unusual performance characteristics are observed, additional measures may be required such as changing orientation or the location of the device.

^b The field strength should be less than 3 V/m for the frequency range of 150 kHz to 80 MHz.

14.7 Recommended Safety Distances Between Portable and Mobile HF Telecommunications Devices and the PNEUMO SURE High Flow Insufflator

Recommended safety distances between portable and mobile HF telecommunications devices and the insufflator

The PNEUMO SURE High Flow Insufflator is intended for use in an electromagnetic environment where HF interferences are controlled. The user/operator of the insufflator can contribute to lowering electromagnetic emissions by complying with the minimum distance between portable and mobile HF telecommunications devices (transmitters) and the insufflator - depending on the output power of the communication device listed below.

Rated output of the transmitter [W]	Safety distance based on the transmitting frequency [m]		
	150 kHz to 80 MHz $d = 1.2\sqrt{P}$	80 MHz to 800 MHz $d = 1.2\sqrt{P}$	800 MHz to 2.5 GHz $d = 2.3\sqrt{P}$
0.01	0.12	0.12	0.23
0.1	0.38	0.38	0.73
1	1.2	1.2	2.3
10	3.8	3.8	7.3
100	12	12	23

The safety distance d in meters [m] for transmitters with a max. rated output not listed in the table above can be calculated by applying the corresponding formula in the respective column. P is the max. rated output of the transmitter in watts [W] according to the information provided by the manufacturer of the transmitter.

Note 1: The higher frequency range applies for 80 and 800 MHz.

Note 2: These guidelines are probably not realizable in all cases. The distribution and spread of electromagnetic quantities differs depending on the absorption and reflection of buildings, objects, and people.

15 Error and Warning Messages

Error and Warning Messages	Cause	Troubleshooting
Check gas supply	(During device check) Existing gas supply pressure is too low.	<ul style="list-style-type: none"> • Open gas bottle or • Replace the gas bottle. • Check the house supply.
	(During surgery) <ul style="list-style-type: none"> • The gas supply pressure has dropped below 15 bar. 	<ul style="list-style-type: none"> • Detach the insufflation tube. • Close gas supply valve. • Replace gas supply. • Open gas supply valve. • Connect insufflation tube. • Continue insufflation.
	<ul style="list-style-type: none"> • Insufficient house gas supply. 	<ul style="list-style-type: none"> • Check the house gas supply. • Open or remove pressure reduction valve if in line with gas bottle. • Check if appropriate house gas connector is used.
Change gas tank	The gas supply pressure has dropped below 30 bar.	<ul style="list-style-type: none"> • Prepare for changing the gas bottle.
Overpressure	The pressure monitor shows that the actual pressure is at least 4 mm Hg above the nominal pressure.	<ul style="list-style-type: none"> • Determine the cause for exceeding the nominal pressure. Check the electronic controls of the device if overpressure exists for a longer period of time (see chapter 13 Annual Inspection, page 78).
	The actual pressure has reached 30 mm Hg / 20 mm Hg (depending on the operating mode).	<ul style="list-style-type: none"> • Reduce the nominal pressure and determine the cause of exceeding the nominal pressure, if possible or necessary.
Venting system active	The actual pressure is at least 2-5 mm Hg and 2-5 s above the nominal pressure.	<ul style="list-style-type: none"> • Determine the cause for exceeding the nominal pressure. Check the electronic controls of the device if overpressure exists for a longer period of time (see chapter 13 Annual Inspection, page 78).
Overpressure/Venting system active.	The pressure monitor shows that the actual pressure is 2-5 mm Hg and 2-5 second above the nominal pressure. The overpressure was not reduced within 5 seconds by the venting system.	<ul style="list-style-type: none"> • Determine the cause for exceeding the nominal pressure. Check the electronic controls of the device if overpressure exists for a longer period of time (see chapter 12.2 Annual Inspection, page 74). Reduce the nominal pressure. Check if the instrument's stopcock is open or the tube is obturated.
Occlusion	Tube or instrument occlusion.	<ul style="list-style-type: none"> • Determine the cause and open/eliminate the occlusion.
	Faulty Veress needle insertion. Stopcock is closed.	<ul style="list-style-type: none"> • Check that the Veress cannula is positioned correctly in the abdomen and make sure the instrument's stopcock is open.
Contamination	Fluid has penetrated the device through the patient gas outlet.	<ul style="list-style-type: none"> • The message is repeated with each Start/Stop. It is possible to continue using the device with this error message until the device is turned off with the ON/OFF key.
Contamination/Call service	The device is contaminated with fluid.	<ul style="list-style-type: none"> • The device has to be checked by an authorized service technician or clearly marked with a label referring to the contamination and then twice enclosed in a safety foil, sealed, and returned to the manufacturer for repairs.
Gas heater defective/Call service	Gas heating malfunction.	<ul style="list-style-type: none"> • Check gas heating with a new tube. If this error message is displayed again, have the device checked by a qualified service technician. It is possible to continue using the device without gas heating.

EN

Error and Warning Messages	Cause	Troubleshooting
<p>Gas temperature >42°C/ Disconnect luer lock / Cool down tube</p> <p>The device terminates gas heating and insufflation.</p>	The temperature of the gas exceeds 42° C.	<ul style="list-style-type: none"> • Unplug the insufflation tube at the trocar. • Press the START/STOP function field. The device insufflates without heating the gas. • Let hot gas escape until the tube is only warm to the touch. • Continue the operation without gas heating or use a different gas heating tube. <p>Turn device off and on again. This reactivates the gas heating.</p> <ul style="list-style-type: none"> • Check gas heating after surgery using a different tube. <p>If this error message is displayed again, have the device checked by a qualified service technician.</p> <p>It is possible to continue using the device without gas heating.</p>
Error message/Call service	The device does not work properly and activates the internal safety system.	<ul style="list-style-type: none"> • Switch the device off and back on after approx. 3 seconds have expired using the ON/OFF key. • Should the error message appear again, the device is defective. Make sure the device can no longer be used until a qualified service technician conducts the appropriate tests and repairs.
<p>Device temperature error/Turn device off</p> <p>The insufflation is stopped or cannot be started.</p>	The device temperature is above 70 °C.	<ul style="list-style-type: none"> • Prepare for changing the gas bottle.
	The device temperature is below 10° C.	<ul style="list-style-type: none"> • Turn the device off for about 10 minutes using the ON/OFF key. The surrounding room temperature must be above 10° C.
Venting valve defective	Venting system malfunctioning.	<ul style="list-style-type: none"> • Use the ON/OFF key to turn the device off and turn device back on after approx. 3 seconds. If this error message is displayed again after the device check has concluded, have the device checked by an authorized service technician. The device can be still operated but without venting system. The error message is repeated with each Start/Stop.
RTP defective	Device defective	<ul style="list-style-type: none"> • It is possible to continue with the surgery but do not connect the measuring line of the RTP system. The message is repeated with each Start/Stop. After surgery is finished, call a service technician to repair the device.
RTP deactivated	Device check was unsuccessful	<ul style="list-style-type: none"> • Surgery can be continued but without the continuous pressure measurement. Please make sure that neither of the two tubes is connected to a trocar or closed off during a device check. Restart device if needed.
Tube set not connected	The tube set has not been connected or has not been inserted correctly but the START function field has been pressed.	<ul style="list-style-type: none"> • Please insert a tube set or check the tube set connection.
Check/change tube set	Leak in tube connection	<ul style="list-style-type: none"> • Please insert a new tube set or check the tube set connection.

16 Technical Data

Mains connection cable:	100-240 V~ line fuse line fuse T 3.15 A connection for potential equalization
Frequency:	50-60 Hz
Max. power consumption:	150 VA
Max. current consumption:	100 V: 1500 mA; 240 V: 630 mA
Classification according to Directive 93/42/EEC:	Ila
Protection class:	I
Protection level:	Type BF
Moisture protection:	IP41
Dimensions:	Width x Height x Depth 318 x 148 x 475 [mm] 12.2 x 5.82 x 18.70 [inch]
Weight:	approx. 9 kg / 19.84 lbs
Operating conditions:	10-40°C / 50-104°F; 30-75% rel. humidity 700 - 1060 hPa ambient pressure
Storage and transportation conditions:	-30 to +70°C / -22 to +158°F; 10-85% rel. humidity 85 - 100% rel. humidity (14 days)
Manufactured and tested according to:	EN 60601-1
EMC:	EN 60601-1-2
Insufflation medium:	Medical CO ₂
Maximum output pressure:	75 mm Hg (1 mm Hg = 1.33 mbar = 133 Pa)
Maximum gas supply pressure:	80 bar/1160 PSI
Minimum gas supply pressure (bottle):	15 bar/218 PSI
Minimum gas supply pressure (house gas):	3.4 bar/50 PSI
Measurement range of gas supply:	0-50 bar/0-725 PSI
Maximum gas flow:	20 l/min Pediatric 40 l/min High Flow 45 l/min Bariatric 10 l/min Vessel Harvest
Pressure range:	1-20 mm Hg Pediatric/Vessel Harvest 1-30 mm Hg High Flow/Bariatric
Accuracy of pressure measurement:	5%
Accuracy of gas flow measurement:	5%
Accuracy of volume measurement:	10%
Accuracy of gas supply pressure measurement:	10%
Connections (optional):	Data input/output, RS232 interface, SIDNE interface

17 Accessories for PNEUMO SURE High Flow Insufflator**17.1 Accessories for Sale in USA**

Order nr.	Item
620-040-620	Pneumo Sure Mode Upgrade Kit to XL
Manuals	
1000-401-015	Pneumo Sure user manual (US Version), Language: EN, ES, FR, PT
1000-401-039	Pneumo Sure user manual (EU 1 Version), Language: EN, DE, FR, NL, PL
1000-401-040	Pneumo Sure user manual (EU 2 Version), Language: EN, NO, SV, DA, FI
1000-401-041	Pneumo Sure user manual (EU 3 Version), Language: EN, ES, IT, PT, EL, RO
1000-401-042	Pneumo Sure user manual (Asia Version), Language: EN, JP, KO, CHS
1000-401-064	Pneumo Sure service manual, Languages: EN, DE
1000-401-014	Pneumo Sure Quick Start Guide, Language: EN
Tube sets	
620-040-660	High Flow II tube set for Pneumo Sure US, sterile, 1 sale unit = 10 individual units
620-040-690	Heated tube set with RTP for Pneumo Sure US, disposable with: -integrated gas heating -simultaneous pressure measuring sterile, 1 sales unit = 10 individual units
620-040-680	High Flow tube set with RTP for Pneumo Sure US, disposable with: -simultaneous pressure measurement sterile, 1 sales unit = 10 individual units
620-040-650	Tube set adapter for Pneumo Sure
Gas Connection	
620-040-002	Gas connection CO2 for house gas supply DISS (US standard)
620-040-003	DISS tube for house gas supply
105-195-003	Gas connection CO2 US
620-010-104	High pressure tube CO2, bottle US/device US, length: 36''
Miscellaneous	
105-208-633	Wrench for high pressure tube US 9/16"
105-189-317	Power supply cord US, 2.5 m
105-170-797	Veress needle 100 mm, chromated
620-030-503	CO2 switching valve for insufflators
105-208-634	Fuse T 3.15 A

17.2 Accessories for Sale Outside of the USA

Order nr.	Item
6000062	Pneumo Sure Mode Upgrade Kit to XL
Manuals	
1200628	Pneumo Sure user manual (US Version), Language: EN, ES, FR, PT
1200631	Pneumo Sure user manual (EU 1 Version), Language: EN, DE, FR, NL, PL
1200632	Pneumo Sure user manual (EU 2 Version), Language: EN, NO, SV, DA, FI
1200633	Pneumo Sure user manual (EU 3 Version), Language: EN, ES, IT, PT, EL, RO
1200629	Pneumo Sure user manual (Asia Version), Language: EN, JP, KO, CHS
1200630	Pneumo Sure service manual, Languages: EN, DE
1200601	Pneumo Sure Quick Start Guide, Language: EN
Tube sets	
Z1463-39	High Flow II tube set for Pneumo Sure EU, sterile, 1 sale unit = 10 individual units
Z1461-39	Heated tube set with RTP for Pneumo Sure EU, disposable with: -integrated gas heating -simultaneous pressure measurement sterile, 1 sales unit = 10 individual units
Z1462-39	High Flow tube set with RTP for Pneumo Sure EU, disposable with: -simultaneous pressure measurement, 1 sales unit = 10 individual units sterile, 1 sales unit = 10 individual units
Z1460-39	Heated tube set, 100x autoclavable
Z1465-39	Tube set adapter EU for heating tube, ISO connector
Z0452-01	Tube set, insufflation with ISO connector, reusable 20 times
Z0536-01	Filter for insufflation, disposable, sterile, ISO-ISO
Gas Connection	
Z5020-01	Gas connection CO2 for house gas supply DISS (US standard)
Z0175-01	Gas connection CO2 US
Z5010-01	Gas connection CO2 for house gas supply NIST (EU standard)
High Pressure Tubes for Bottle Supply	
Z5044-01	High pressure tube CO2 bottle DIN/device US, length 1.5 m
Z5045-01	High pressure tube CO2 bottle ISO/device US, length 1.5 m
Z0499-01	High pressure tube CO2 bottle PIN/device US, length 1.5 m
Z0498-01	High pressure tube CO2 bottle US/device US, length 1.5 m
Wrench for High-Pressure Tubes	
Z0600-01	Wrench for high pressure tube US, 9/16"
Z0601-01	Wrench for high pressure tube DIN, WS 30
Z0602-01	Wrench for CO2 bottle PIN Index, WS 5.5

EN



Service and Claims:

CAUTION!

Do not attempt any service not outlined in this manual.

If service is needed either during or after the warranty period:

- Contact Stryker Endoscopy at **1-800-624-4422** or phone your local Stryker Endoscopy sales representative.
- Package all the components carefully in the original shipping container if possible.
- Ship the device, prepaid and insured to:

Stryker Endoscopy Customer Service
Attention: Repair Department
5900 Optical Court
San Jose, CA 95138

For service outside of the United States, visit our website at www.stryker.com for the appropriate service address.

Index**A**

Authorized service technician 4
Autoclave sterilization 77

C

Care and maintenance 4
Certification 74
Check gas heating after surgery 21
Configuration menu 58
Configuration menu II 64
Connecting the gas heating 20
Connecting the tube set 19
Contamination 4
Contamination/Call service 72
Contraindications 8, 51

D

Data transfer 82
Delivery inspection 14

E

Error detection and monitoring 22, 72
Error message "Contamination" 71
Error message when starting with defective venting valve 72
ESD (Electrostatic Discharge) precautionary measures 82
Exceeding nominal pressure 70
Exceeding nominal pressure for more than 5 seconds 70
Exclusion of liability 4

F

Federal Law 4
Functions of the configuration menu 60

G

Gamma ray sterilization 77
Gas heating 82
Gas heating display 20
Gas heating ON/OFF 21
Gas sterilization 77
Gas supply displays 17, 71
Gas supply with gas bottle 17, 71
Gas temperature exceeds 42 °C 21
Grounding contact 14

H

House gas supply 18

I

Incorrect/defective heating tube 21
Insufflation
 Pediatric 38
Insufflation source 70
Intended use 7, 26, 43, 51

L

Leakage detection 22

M

Mains connection 14
Manufacturer's specifications 74
Measured values and tolerances 78

N

Nominal pressure limit 30 mm Hg / 20 mm Hg 70
Notes about the Veress cannula 76

O

Only for U.S. operators 14

P

Pediatric operating mode 34

Potential equalization 14

Power failure 73

Precautionary measures 82

Preparation 29, 47,

R

Removing the tube set 20

Resetting the display 24

S

Setting the venting pressure limit of the venting valve 62

Setting the venting system response time 62

Setting the venting valve status 61

Setting up the device 14

T

Testing gas heating functionality 30

Testing the device 30, 39, 47, 55

Two-year maintenance interval 74

U

Using the device during surgery 31, 56

Utility menu 66

V

Veress insufflation 38

W

Warning message "Occlusion" 71

Waste management 4

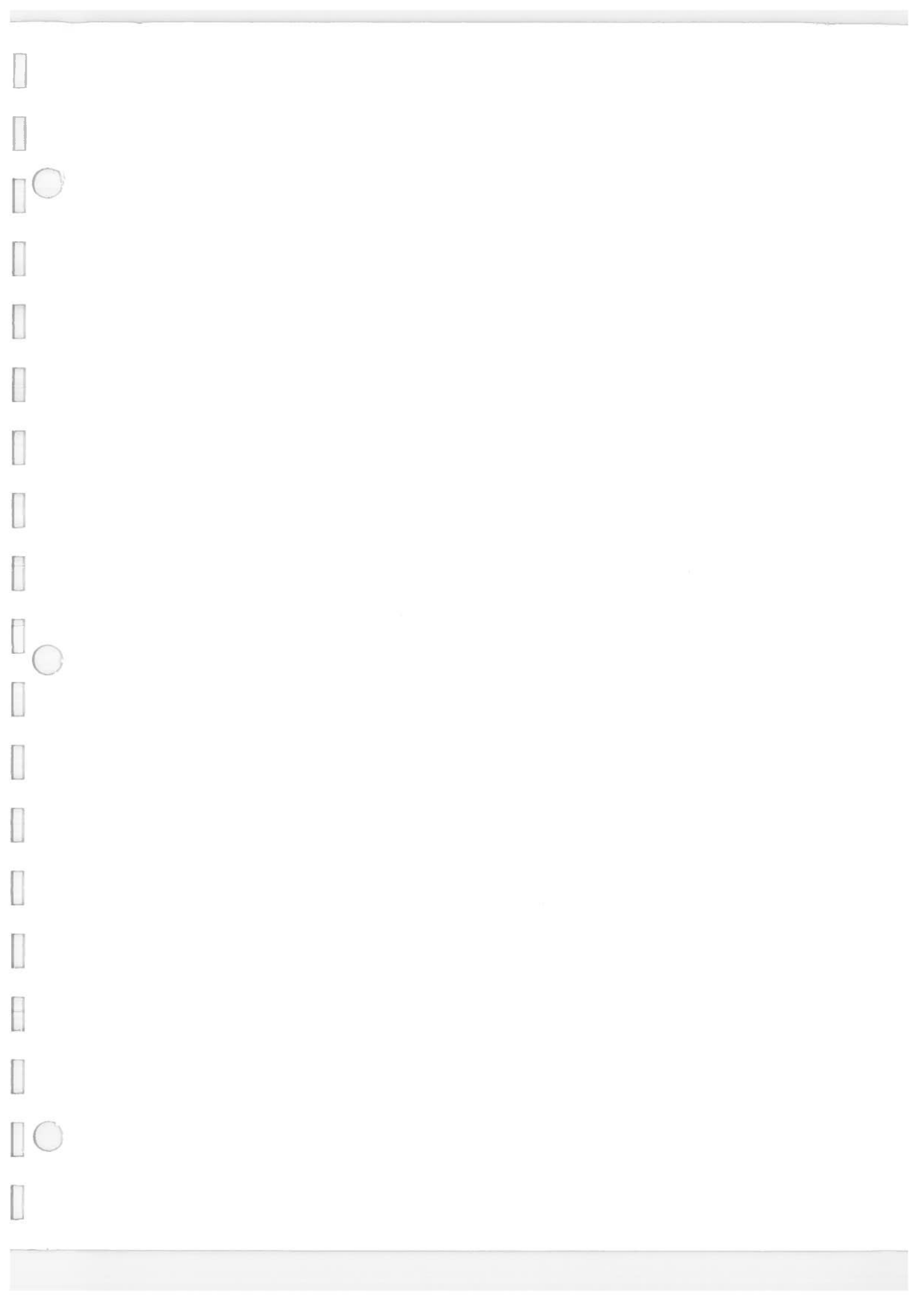

stryker

Produced for:



Stryker Endoscopy
5900 Optical Court San Jose
CA 95138 (USA)
+1.408.754.2000
+1.800.624.4422
www.stryker.com