

Patient Monitor WE-9001

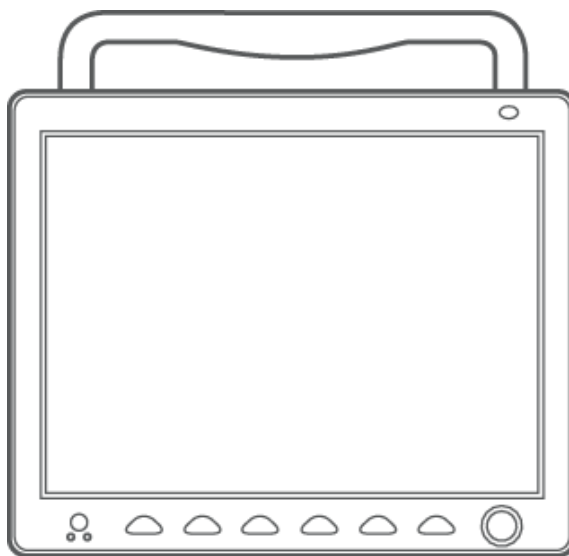

User Manual

Whittemore Enterprises, Inc.

Copyright

Statement

Our company owns all rights to this unpublished work and intends to maintain this work as confidential. We may also seek to maintain this work as an unpublished copyright. This publication is to be used solely for the purposes of reference, operation, maintenance, or repair of our equipment. No part of this can be disseminated for other purposes.

In the event of inadvertent or deliberate publication, our company intends to enforce its rights to this work under copyright laws as a published work. Those having access to this work may not copy, use, or disclose the information in this work unless expressly authorized by us to do so.

All information contained in this publication is believed to be correct. Our company shall not be liable for errors contained herein nor for incidental or consequential damages in connection with the furnishing, performance, or use of this material. This publication may refer to information and protected by copyrights or patents and does not convey any license under the patent rights of our company, nor the rights of others. Our company does not assume any liability arising out of any infringements of patents or other rights of third parties.

Content of this manual is subject to changes without prior notice.

Responsibility on the manufacturer party

Our company is responsible for safety, reliability and performance of this equipment only in the condition that:

- all installation, expansion, change, modification and repair of this equipment are conducted by our qualified personnel; and,
- applied electrical appliance is in compliance with relevant National Standards; and,
- the monitor is operated under strict observance of this manual.

Note

-
- **This equipment is not intended for family usage.**
-



Warning

-
- This monitor is not a device for treatment purpose.
-

It is important for the hospital or organization that employs this equipment to carry out a reasonable maintenance schedule. Neglect of this may result in machine breakdown or injury of human health.

Upon request, our company may provide, with compensation, necessary circuit diagrams, calibration illustration list and other information to help qualified technician to maintain and repair some parts, which our company may define as user serviceable.

Warranty

Workmanship & Materials

Our company's guarantees new equipment other than accessories to be free from defects in workmanship and materials for a period of 18 months (six months for multi-site probes and SpO₂ sensor) from date of shipment under normal use and service. Our company's obligation under this warranty is limited to repairing, at our company's option, any part which upon our company's examination proves defective.

this warranty is exclusive and is in lieu of all other warranties, expressed or implied, including warranties of merchant ability or fitness for any particular purpose.

Exemptions

Our company's obligation or liability under this warranty does not include any transportation or other charges or liability for direct, indirect or consequential damages or delay resulting from the improper use or application of the product or the substitution upon it of parts or accessories not approved by us or repaired by anyone other than a our company authorized representative.

This warranty shall not extend to any instrument which has been subjected to misuse, negligence or accident; any instrument from which our company's original serial number tag or product identification markings have been altered or removed, or any product of any other manufacturer.

Safety, Reliability and Performance

Our company is not responsible for the effects on safety, reliability and performance of the Monitor if:

- assembly operations, extensions, re-adjusts, modifications or repairs are carried out by persons other than those authorized by us.
- the Monitor is not used in accordance with the instructions for use, or the electrical installation of the relevant room does not comply with NFPA 70: National Electric Code or NFPA 99: Standard for Health Care Facilities (Outside the United States, the relevant room must comply with all electrical installation regulations mandated by the local and regional bodies of government).

Return Policy

Return Procedure

In the event that it becomes necessary to return a unit to our company, the following procedure should be followed:

- Obtain return authorization. Contact our Service Department and obtain a Customer Service Authorization number. The number must appear on the outside of the shipping container. Return shipments will not be accepted if the number is not clearly visible. Please provide the model number, serial number, and a brief description of the reason for return.
- Freight policy. The customer is responsible for freight charges when equipment is shipped to our company for service (this includes customs charges).

Preface

This manual gives detailed description to the Monitor concerning its performance, operation, and other safety information. Reading through this manual is the first step for the user to get familiar with the equipment and make the best out of it.

Following symbols indicates some important facts that you have to pay special attention to:



Warning Points to be noted to avoid injury to the patient and the operator.



Caution Points to be noted to avoid damage to the equipment.

Note Points to be noted.

This manual is intended for persons who are trained in the use of this field and have adequate experience in operation of monitoring equipment.

Contents

Chapter1	Introduction.....	1
1.1	General Information.....	2
1.2	Screen Display.....	2
1.3	Button Functions.....	4
1.4	Interfaces.....	5
1.5	Built-in Battery.....	8
Chapter2	Getting Started.....	9
2.1	Open the Package and Check.....	9
2.2	Connect the Power Cables.....	9
2.3	Power on the Monitor.....	9
2.4	Connect Patient Sensors.....	9
2.5	Check the Recorder.....	10
Chapter3	System Menu.....	11
3.1	Patient Information Setup.....	11
3.2	Default Setup.....	12
3.3	Recall.....	13
3.4	System Setup.....	13
3.5	Monitor Version.....	21
3.6	Drug Calculation.....	21
3.7	Maintenance.....	21
3.8	DEMO Function.....	24
Chapter4	Alarm.....	25
4.1	Alarm Modes.....	25
4.2	Alarm Verification during Power On.....	26
4.3	Alarm Cause.....	26
4.4	SILENCE and PAUSE.....	27
4.5	Parameter Alarm.....	27
4.6	When an Alarm Occurs.....	27
Chapter5	Freeze.....	28
5.1	General.....	28
5.2	Enter/Exit Freeze Status.....	28
5.3	FREEZE Menu.....	28
5.4	Reviewing Frozen Waveform.....	28
5.5	Recording Frozen Waveform.....	29
Chapter6	Recording.....	30
6.1	General Information on Recording.....	30
6.2	Recording Type.....	30
6.3	Recording Startup.....	31
6.4	Recorder Operations and Status Messages.....	32
Chapter7	Recall.....	34
7.1	Trend Graph.....	34
7.2	Trend Table.....	35
7.3	NIBP Recall.....	36
7.4	Alarm Event Recall.....	36
7.5	SD Operate.....	37

Chapter8	Drug Calculation and Titration Table	43
8.1	Drug Calculation	43
8.2	Titration Table	44
Chapter9	Patient Safety	45
Chapter10	Care / Cleaning	48
10.1	System Check	48
10.2	General Cleaning	48
10.3	Cleaning Agents.....	48
10.4	Disinfection.....	49
Chapter11	ECG/RESP Monitoring.....	50
11.1	What is ECG Monitoring	50
11.2	Precautions during ECG Monitoring	50
11.3	Monitoring Procedure.....	50
11.4	ECG Screen Hot Keys	54
11.5	ECG Menu	54
11.6	ECG Alarm Information and Prompt.....	56
11.7	ST Segment Monitoring.....	57
11.8	Arr. Monitoring.....	60
11.9	Measuring RESP.....	63
11.10	Maintenance and Cleaning	65
Chapter12	SpO ₂ Monitoring.....	66
12.1	What is SpO ₂ Monitoring.....	66
12.2	Precautions during SpO ₂ /Pulse Monitoring.....	66
12.3	Monitoring Procedure.....	67
12.4	Limitations for Measurement	68
12.5	SpO ₂ Menu.....	69
12.6	Alarm Description and Prompt.....	70
12.7	Maintenance and Cleaning	71
Chapter13	NIBP Monitoring	72
13.1	Introduction.....	72
13.2	NIBP Monitoring	72
13.3	NIBP SETUP Menu	75
13.4	NIBP Alarm Message	77
13.5	Maintenance and Cleaning.....	78
Chapter14	TEMP Monitoring.....	80
14.1	TEMP Monitoring.....	80
14.2	TEMP SETUP Menu	80
14.3	TEMP Alarm message	81
14.4	Care and Cleaning.....	81
Chapter15	IBP Monitoring(optional).....	83
15.1	Introduction.....	83
15.2	Precautions during IBP Monitoring.....	83
15.3	Monitoring Procedure.....	83
15.4	IBP Menu.....	84
15.5	Alarm Information and Prompts	88
15.6	Maintenance and Cleaning	90

Chapter16	CO ₂ Measuring(optional)	92
16.1	General	92
16.2	Monitoring Procedure	92
16.3	CO ₂ Menu	94
16.4	Alarm Information and Prompt	96
16.5	Maintenance and Cleaning	97
Chapter17	Accessories and Ordering Information	98
17.1	ECG Accessories	98
17.2	SpO ₂ Accessories	98
17.3	NIBP Accessories	99
17.4	TEMP Accessories	99
17.5	IBP Accessories	99
17.6	CO ₂ Accessories	99
Chapter18	Default Settings Appendix	101
18.1	Country-Specific Default Settings	101
18.2	Alarm and Measurement Default Settings	106
Appendix I		109
Appendix II		114
Appendix III		121
Appendix IV		125

Chapter1 Introduction

- For an overall introduction to the monitor, please refer to **General Information**.
- For various messages displayed on the screen, please refer to **Screen Display**.
- For basic operating instructions, please refer to **Button Function**.
- For allocation of interface sockets, please refer to **Interfaces**.
- For important facts to be noted during the battery recharging procedure, please refer to **Built-in Battery**.



Warning

- The Monitor is intended for clinical monitoring application with operation only granted to appropriate medical staff.
- The monitor can be used on only one patient at a time.
- There could be hazard of electrical shock by opening the monitor casing. All servicing and future upgrading to this equipment must be carried out by personnel trained and authorized by our company.
- To avoid the risk of electric shock, this equipment must only be connected to a supply mains with protective earth.
- Possible explosion hazard if used in the presence of flammable anesthetics or other flammable substance in combination with air, oxygen-enriched environments, or nitrous oxide.
- You must verify if the device and accessories can function safely and normally before use.
- You must customize the alarm setups according to individual patient situation and make sure that alarm sound can be activated when alarm occurs.
- Do not use cellular phone in the vicinity of this device. High level electromagnetic radiation emitted from such devices may greatly affect the monitor performance.
- Do not touch the patient, table, or the device during defibrillation.
- Devices connected to the monitor shall form an equipotential system (protectively earthed).
- When used with Electro-surgery equipment, you (doctor or nurse) must give top priority to the patient safety.
- Do not place the monitor or external power supply in any position that might cause it to fall on the patient. Do not lift the monitor by the power supply cord or patient cable, use only the handle on the monitor.
- Consult IEC60601-1-1 for system interconnection guidance. The specific requirements for system interconnection are dependent upon the device connected to the monitor and the relative locations of each device from the patient, and the relative location of the connected device to the medically used room containing the monitor. In all circumstance the monitor must be connected to a grounded AC power supply. The monitor is referred to as an IEC 601/F device in the summary of situations table contained in IEC 60601-1-1.
- Dispose of the packaging material, observing the applicable waste control regulations and keeping it out of children's reach.
- Grounding: Connect the monitor only to a three-wire, grounded, hospital-grade receptacle. The three-conductor plug must be inserted into a properly wired three-wire receptacle; if a three-wire receptacle is not available, a qualified electrician must install one in accordance with the governing electrical code.
 - Do not under any circumstances remove the grounding conductor from the power plug.
 - Do not use extension cords or adapters of any type. The power cord and plug must be intact and undamaged.
 - If there is any doubt about the integrity of the protective earth conductor arrangement, operate the monitor on internal battery power until the AC power supply protective conductor is fully functional.

Note

- The software was developed per IEC62304. The possibility of hazards arising from errors in the software program is minimized.



Caution

- The monitor's service life is 5 years. At the end of its service life, the product described in this manual, as well as its accessories, must be disposed of in compliance with the guidelines regulation the disposal of such

- **products. If you have questions concerning disposal of the product, please contact us or its representatives.**
- **If you have any doubt to the grounding layout and its performance, you must use the built-in battery to power the monitor.**

1.1 General Information

Environment:

Temperature		
	Working	+5°C ~ +40°C
	Transport and Storage	-40°C ~ +55°C
Humidity		
	Working	30% ~ 75%
	Transport and Storage	≤ 95 % (no coagulate)
Barometric		
	Working	700hPa ~ 1060hPa
	Transport and Storage	500hPa ~ 1060hPa
Power Supply		
		100-240V~ 50/60Hz
		Pmax = 150VA
		FUSE T1.6AL250V

General instruction:

The monitor has abundant monitoring functions and is used for the clinical monitoring of adult, pediatric and neonate(SpO₂ function is inapplicable on neonate in American). In addition, the user may select the different parameter configuration according to different requirements.

The monitor can be connected to the central monitoring system via our network so as to form a network monitoring system.

This machine can monitor vital signals as ECG, Respiratory Rate, SpO₂, NIBP, and Dual-TEMP, Dual-IBP, CO₂. It integrates parameter measuring modules, display and recorder in one device, featuring in compactness, lightweight and portability. Replaceable built-in battery facilitates transportation of patient. Large high-resolution display provides clear view of 8 waveforms and full monitoring parameters.

The POWER switch is on the front panel. The POWER switch lights when the device is powered on. The ALARM indicator is on the front panel. The ALARM indicator flashes or lights when alarm occurs. The sockets of the sensors are at the left side. The recorder socket is at the right side. Other sockets and power plug-in are at the rear panel.

This monitor is a user-friendly device with operations conducted by a few buttons and a rotary knob on the front panel. Refer to 1.3 Button Functions for details.

The Monitor performs monitoring of:

ECG	Heart Rate (HR)
	2-channel ECG waveforms
	Arrhythmia and S-T segment analysis(optional)
RESP	Respiratory Rate (RR)
	Respiration Waveform
SpO₂	Oxygen Saturation (SpO ₂), Pulse Rate (PR)
	SpO ₂ Plethysmogram
NIBP	Systolic Pressure (SYS), Diastolic Pressure (DIA), Mean Pressure (MEAN)
TEMP	Channel-1 Temperature (T1), Channel-2 Temperature (T2), Temperature Difference between two channels (TD)
IBP	Channel-1 SYS, DIA, MAP
	Channel-2 SYS, DIA, MAP
	Dual-IBP waveforms
CO₂	End Tidal CO ₂ EtCO ₂
	Inspired Minimum CO ₂ (InsCO ₂)
	Air Way Respiration Rate(AwRR)

The monitor provides extensive functions as visual & audible alarm, storage and report printout for trend data, NIBP measurements, and alarm events, oxyCRG, ViewBed, and drug dose calculation function is provided too.

1.2 Screen Display

The display of the multi-parameter monitor is a color LCD, which can display the collected patient parameters, waveforms, alarm information as well as bed number, time and monitor status, etc.

The screen is divided into three areas(Figure 1-1): Information area①, waveform area②, parameter area③.

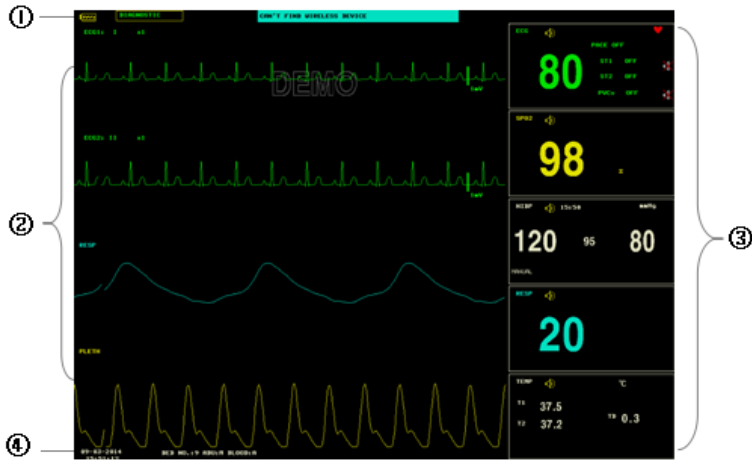





Figure 1-1 Main Display

Information Area



The Message Area is at the top and bottom part of the screen, displaying the current status of both the monitor and the patient.

At the top(①)

Information will appear and disappear together with the reported status. According to the content, the information is divided into:

- Battery indicator
- Filter way
- Prompt information, reporting the current status of the monitor or sensor/probe.
-  flag for alarm PAUSE. Press “SILENCE” button once (less than 1 second) to mute all alarm sounds and the flag appears at the same time. Press the button again to terminate the PAUSE status. The duration for PAUSE status can be 1 minute, 2 minutes or 3 minutes.
-  flag for alarm SILENCE. Press “SILENCE” button once (more than 1 second) to manually mute all the sounds and this flag appears at the same time. The SILENCE status terminates when you discharge the status or new alarm occurs.
-  flag for Alarm Volume Off. It appears indicating that you have closed the alarm sound permanently. This status terminates when you discharges the status.

Note

- If  symbol appears, the system will no longer give audible alarm sound. You must be very careful in using this function. Two ways can be used to discharge this status. One is to set the alarm volume to an option other than OFF in the USER MAINTAIN menu. The other method is to press SILENCE button to make the flag turn to . And then press SILENCE again and the system will restore the normal alarm status.

- Parameter alarm information is displayed always in the upper right corner of the screen.
- When the waveforms on the screen are frozen, the FREEZE prompt will appear in the bottom part of the screen.

At the bottom(④)

- Patient information include:

BED NO .	Bed number of patient under monitoring
Patient type	Three options: Adult, Pediatric, Neonate
“01-01-2005”	Current date
“07:11:17”	Current time

M Patient sex, Male or Female
BLOOD Patient blood type

Waveform / Menu Area(②)

The waveform area can maximally display 8 waveforms. The displaying order of the waveforms on the screen can be adjusted. For the maximum configuration, the waveforms provided by the system for selection are: 2 ECG waveforms, SpO₂ waveform, 2IBP waveforms,RESP waveform, CO₂ waveform.

All the waveforms in the system are listed out in the “WAVE SETUP” menu. The user may adjust their displaying positions. The specific method is illustrated in the part: WAVE SETUP.

The name of the waveform is displayed on the upper left part of the waveform. The user may choose ECG lead based on the requirements. The gain of the channel are also displayed on each ECG waveform. A 1mV scale bar is also displayed to one side of ECG waveform. The IBP waveform scale can also be selected according to the actual requirement. In the IBP waveform area, the waveform scale is displayed. The three dotted lines for each IBP waveform form up to down represent respectively the upper limit scale, reference scale and lower limit scale. The values of these three scales can be set. The specific method is given in the part: Measure IBP.

When menu is wanted during screen operation, the menu always occupies the fixed position in the middle part of the waveform area, therefore part of waveform can not be viewed temporarily. After exiting the menu, the system will restore the original screen.

The user may set up the rate to refresh the waveform. The method to adjust the refreshing rate of each waveform is discussed in the setup description of each parameter.

Parameter Area(③)

The parameter area lies to the right side of the waveform area, whose position basically corresponds to the waveform. The parameters displayed in the parameter area include:

- ECG
 - Heart rate or pulse rate (unit: beats/minute)
 - The ST analyzing result of channel 1 and 2: ST1, ST2 (unit: mV)
 - PVCs(unit: times/minute)
- NIBP
 - From left to right, there are Systolic pressure, Mean pressure and Diastolic pressure(unit: mmHg or kPa)
- SpO₂
 - SpO₂(unit: %)
 - Pulse Rate(unit: beats/minute)(When “BOTH” item is selected)
- IBP
 - The blood pressure of channel 1 and 2. From left to right, there are Systolic pressure, Mean pressure and Diastolic Pressure(unit:mmHg / kPa / cmH₂O)
- CO₂
 - EtCO₂(unit:mmHg or kPa)
 - INS CO₂ (unit: mmHg or kPa)
 - AwRR(times/minute)
- RESP
 - Respiration Rate(unit: times/minute)
- TEMP
 - Temperature of channel 1 and 2: T1, T2 and the difference between them TD. (unit: °C or °F)

Alarm lamp and alarm status:

In normal status: the alarm lamp is not on.

When alarm exists, the alarm lamp flashes or lights on. The color of the lamp corresponds to the alarm level. Refer to related chapter: Alarm.

For the details of alarm information and prompt information, refer to the related content of each parameter in related chapter.

Warning

- **Always verify the self-check function of audible and visual (LED) alarms when powers on.**
-

1.3 Button Functions

All the operations to the monitor are through the buttons and a knob at the bottom of the screen. The names of the buttons are below them. They are:

- **MAIN**



Whatever levels of menu the system is in, press the button and the system will always return to the main screen.

- **FREEZE**

Press this button and the system will access the FREEZE status. In this status the user may review the waveform of 34 seconds. Also, the frozen waveform can be printed out. In the FREEZE status, press this button again to discharge the FREEZE status. For detailed information, refer to related chapter: Freeze.

- **SILENCE**

Push this button for less than 1 second to suspend alarm for maximum 3 minutes (with 1 minute, 2 minutes and 3 minutes selectable). In Alarm PAUSE status, a  symbol appears in the Message Area. Push this button for more than 1 second to mute all kinds of sounds (including alarm sound, heart beat, pulse tone, key sound). At the same time,

a  symbol appears in the Message Area. Push this button again to restore all kinds of sounds and the  symbol disappears from the screen.

Note

-
- **If new alarm occurs in Alarm Silence status, the system will discharge Pause/Silence status automatically. For specific rules, see Chapter Alarm.**
 - **The system will begin to give alarm information again once there exist alarm-triggering event. Nevertheless, remember pushing SILENCE button can permanently shut off audible alarm sound of ECG LEAD OFF and SpO₂ SENSOR OFF alarms.**
-

- **START**

Press to inflate the cuff to start a blood pressure measurement. When measuring, press to cancel the measurement and deflate the cuff.

- **REC/STOP**

Press to start a real time recording. The recording time is set in RECORD SETUP. Press during recording to stop the recording. For detailed information, refer to related chapter.

- **MENU**

Press this button to call up the SYSTEM MENU, in which the user may set up system information and perform review operation. For detailed information, refer to related chapter: System Menu and related chapter: Trend and Event.

- **Rotary knob**

The user may use the rotary knob to select the menu item and modify the setup. It can be rotated clockwise or counter-clockwise and pressed like other buttons. The user may use the knob to realize the operations on the screen and in the system menu and parameter menu.

Method to use the knob to operate on the screen:

The rectangular mark on the screen that moves with the rotation of the knob is called “cursor”. Operation can be performed at any position at which the cursor can stay.

When the cursor is in the waveform area, the user may immediately modify the current setup. When the cursor is in the parameter area, the user may open the setup menu of the corresponding parameter module so as to set up the menu items of the module.

Operating method:

- Move the cursor to the item where the operation is wanted
- Press the knob
- One of the following four situations may appear:
 1. The cursor with yellow frame becomes into the one with cyan frame, which implies that the content in the frame can change with the rotation of the knob.
 2. Menu or measuring window may appear on the screen, or the original menu is replaced by the new menu.
 3. A check mark “✓” appears at the position, indicating that the item is confirmed.
 4. The system immediately executes a certain function.

1.4 Interfaces

For the convenience of operation, the different kinds of interfaces are in different parts of the monitor.

- Front view

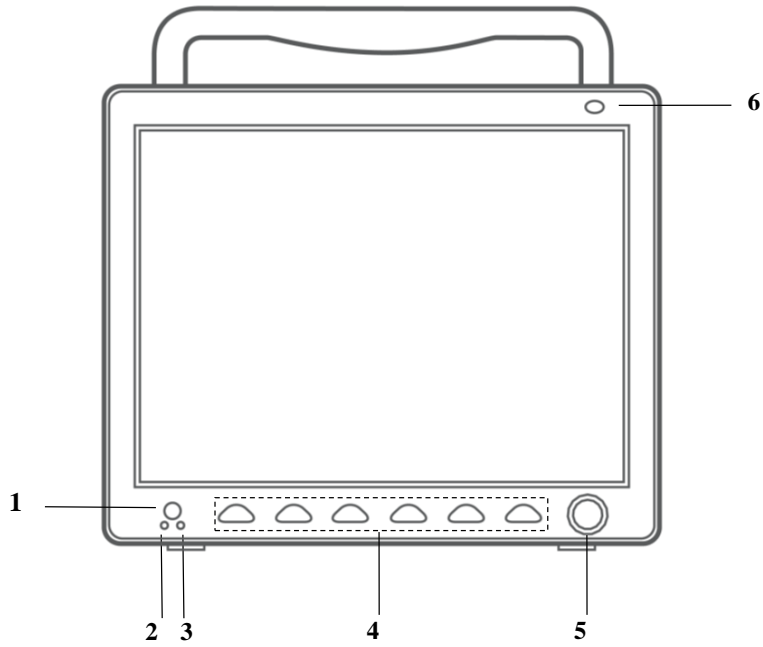

Figure 1-2 Front View

1	ON/OFF button ON: press this button to turn on the device OFF: under device on state, press this button for 3 seconds to turn it off
2	AC indicator: the device has connected to external AC power
3	Running indicator: the device is running
4	Refer to Chapter 1.3 Button Functions for details
5	Rotary knob: refer to Chapter 1.3 Button Functions for details
6	Alarm indicator: indicating different alarm level with different color and flicking frequency

■ **Right side view**

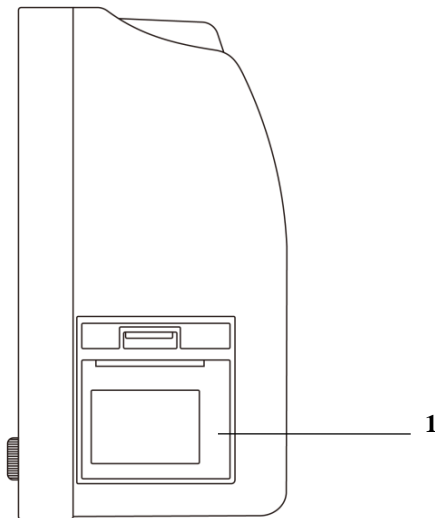

Figure 1-3 Right Side

1	Recorder
---	----------

■ **Left side view**

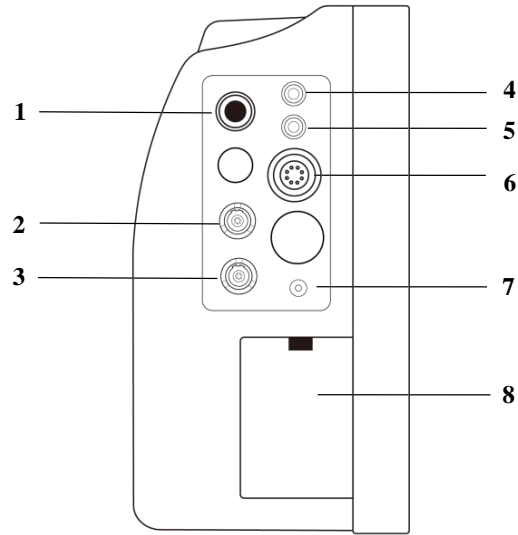

Figure 1-4 Left Side

1	Socket for SpO ₂ Sensor
2	Socket for IBP module
3	Socket for CO ₂ module
4	Socket for channel 1 TEMP probe
5	Socket for channel 2 TEMP probe
6	Socket for ECG cable
7	Socket for NIBP cuff
8	Battery cover



Indicates that the instrument is IEC 60601-1 Type CF equipment. The unit displaying this symbol contains an F-Type isolated (floating) patient applied part providing a high degree of protection against shock, and is suitable for use during defibrillation.

■ **Rear view**

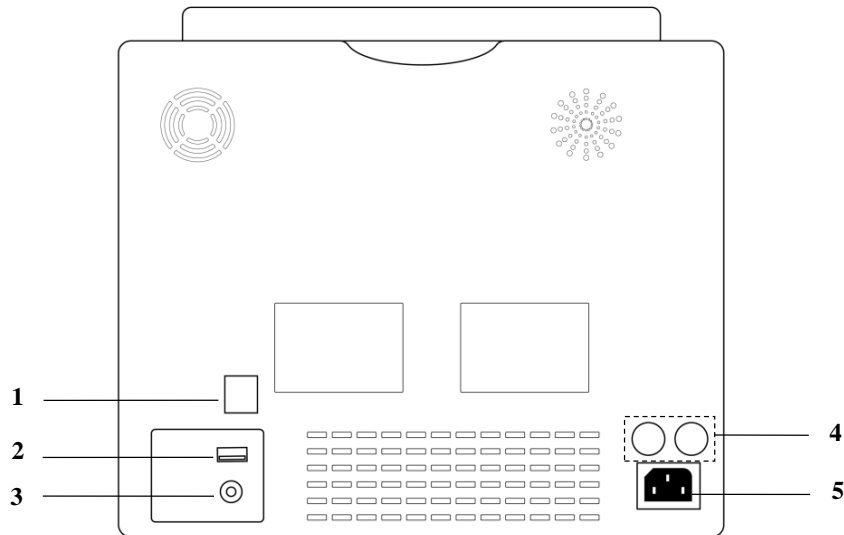



Figure 1-5 Rear Panel

1	Network Interfaces, Standard RJ45 Socket, connecting with other beds or central monitoring system through standard network cable
2	USB, used for program upgrading, SD card data storage, connecting with central monitoring system by wireless mode
3	Equipotential grounding terminal for connection with the hospital's grounding system
4	Fuse T1.6AL250V
5	Power Supply, 100-240V~ 50/60Hz

⚠ Warning

- **Through network interface only our company's Central Monitoring System can be connected in.**
-

1.5 Built-in Battery

The Monitor is equipped with rechargeable batteries. The battery in the monitor can automatically recharge when connected to AC INPUT until it is full. A symbol “” is displayed on the upper left quarter of the screen to indicate the status of recharging, in which the YELLOW part represents the relative electric energy of the battery. And, if the battery is not installed in the monitor, battery state will be displayed as “” to indicate that no battery is available. Under connectors to patient cables there are battery slots with cover. See Figure 1-4 Battery Slot Cover.

⚠ Warning

- **Don't pull off battery during monitoring.**
 - Remove the battery if the ME EQUIPMENT is not likely to be used for long time.
 - **The battery shall be only applied on this device. Any maintenance or replacement upon the battery should be processed by the service personnel trained and authorized by our company.**
 - When operating on battery, the monitor will prompt alarm and shut off automatically when the energy is low. When the electric energy is going out, the monitor will sound continuous level 1 alarm beeping and display “BATTERY LOW” in the Message Area. Connect the monitor to AC power at this moment can recharge the battery while operating. If keep operating on the battery, the monitor will shut off automatically (about 5 minutes since alarming) upon exhaustion of the battery.
-

Chapter2 Getting Started

- Open the package and check
- Connect the power cables
- Power on the monitor
- Connect patient sensors
- Check the recorder

Note

-
- **To ensure that the monitor works properly, please read Chapter Patient Safety, and follow the steps before using the monitor.**
-

2.1 Open the Package and Check

Open the package and take out the monitor and accessories carefully. Keep the package for possible future transportation or storage. Check the components according to the packing list.

- Check for any mechanical damage.
- Check all the cables, modules and accessories.

If there is any problem, contact the distributor immediately.

2.2 Connect the Power Cables

Connection procedure of the AC power line:

- Make sure the AC power supply complies with following specification: 100-240V~ 50/60Hz.
- Apply the power line provided with the monitor. Plug the power line to INPUT interface of the monitor(Socket ⑥ in Figure 1-4). Connect the other end of the power line to a grounded 3-phase power output.

Note

-
- **Connect the power line to the jack special for hospital usage.**
 - Connect to the ground line if necessary. Refer to **Chapter Patient Safety** for details.
 - **Make sure that the POWER lamp now lights. If it does not light, check your local power supply. If the problem still exists, contact the local Customer Service Center.**
 - **If the power supply is not properly connected before turning on the monitor, it may not work properly because of insufficient power. Connect the power supply to charge the battery.**
-

2.3 Power on the Monitor

Press POWER to power on the monitor. Then a beep will be heard and at the same time the indicator will flash once in orange. After 10 seconds or so, the system will enter monitoring screen after self-test, and you can perform normal monitoring now.

Note

-
- **If the monitor finds any fatal error during self-test, it will alarm.**
 - **Check all the functions that may be used to monitor and make sure that the monitor is in good status.**
 - **When the supply mains is interrupted, the monitor will work with battery.**
 - **The battery must be recharged to the full electricity after each use to ensure adequate electricity reserve.**
 - **The interval between twice press of POWER should be more than 1 minute.**
-



Warning

-
- **If any sign of damage is detected, or the monitor displays some error messages, do not use it on any patient. Contact biomedical engineer in the hospital or our Customer Service Center immediately.**
-

2.4 Connect Patient Sensors

Connect all the necessary patient sensors between the monitor and the patient.

Note

-
- **For information on correct connection, refer to related chapter 11-16.**
-

2.5 Check the Recorder

If your monitor is equipped with a recorder, open the recorder door to check if paper is properly installed in the output slot. If no paper present, refer to Chapter Recording for details.

Chapter3 System Menu

This monitor features flexible configurations. You can customize monitoring content, waveform sweep speed, sound volume, and output content.

Press the MENU button on the front panel of the monitor to call up the “SYSTEM MENU”. You can perform following operations in this menu.

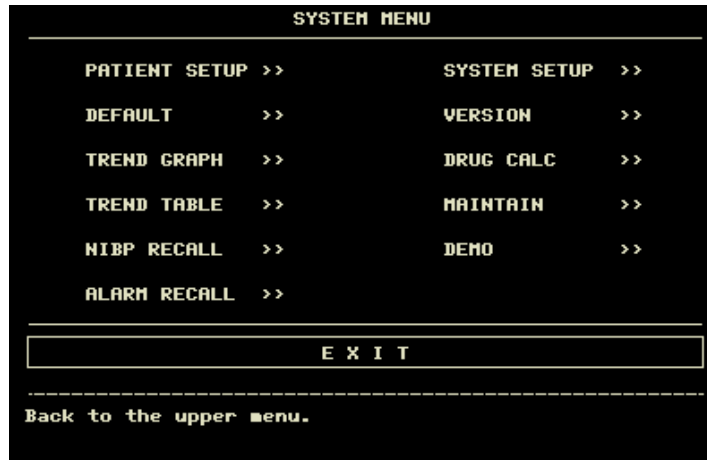

Figure 3-1 SYSTEM MENU

Trend graph/table review, NIBP review and alarm review are discussed in Chapter 7 Recall.

3.1 Patient Information Setup

Pick the [PAT SETUP] item in the “SYSTEM MENU” to call up the following menu.

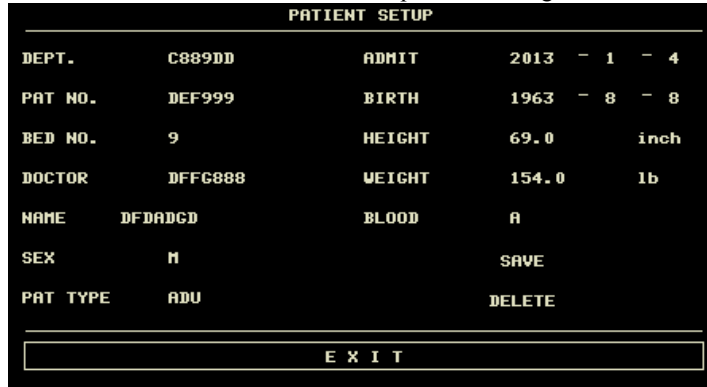

Figure 3-2 Patient Setup

You can setup following patient information:

DEPT.	Department in which the patient receives treatment.
PAT NO.	Patient No.
BED NO.	Patient bed number (Range: 1-100)
DOCTOR	Name of the doctor.
NAME	Patient name (Valid characters: A-Z, 0-9 and space bar; Max. length: 12 characters)
SEX	Patient gender (Available options: "F" for Female, "M" for Male)
PAT TYPE	Patient type (Available options: ADU, PED, and NEO)
ADMIT	Hospitalization starting date (format: year\month\ day)
BIRTH	Patient date of birth (format: year\month\day)
HEIGHT. (cm/inch)	Patient height (turning the knob with the increase/decrease of 0.5 cm/inch each time)The other HT. unit in the other menus accord with the unit which you choosed here.
WEIGHT. (kg/lb)	Patient weight (turning the knob with the increase/decrease of 0.5 kg/lb each time)The other WT. unit in the other menus accord with the unit which you choosed here.
BLOOD	Patient blood type (Pick A, B, O, AB, or N. "N" represents unknown blood type)
SAVE	To change the patient's information you must click this button to save.
DELETE	To initialize the Patient Setup menu.

Also in this menu, you may select the [DELETE] item to access the "CONFIRM TO DELETE" dialog box as show bellow, in which you can decide whether to clear current patient information.



Figure 3-3 Confirm to Delete

Pick [YES] to initialize the previous menu and exit the menu.

Pick [NO] to give up updating the patient and the system will keep the information of the currently patient and exit the menu.

3.2 Default Setup

Note

- After selecting any item in this sub-menu, the selected item will replace the current setup of the system and accordingly become the system default configuration.



Figure 3-4 Default Menu

In this sub-menu, you can select both the factory default and the user-defined default. Also in this sub-menu, you can save the current system configuration as the user-defined default configuration. But at this time, the system will

automatically save all the setups in the parameter menu, ECG gain and filter way as the user-defined default configuration according to the patient type. Also, the dialog box as shown below will pop up.

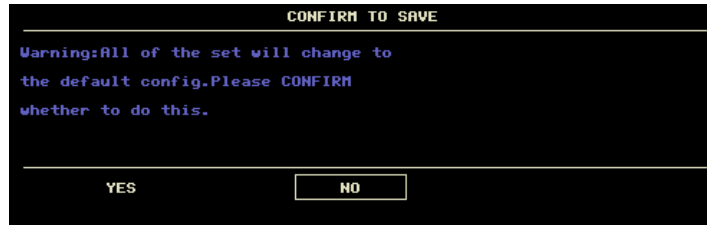

Figure 3-5 Confirm Default Config

Note

- After selecting any item in the DEFAULT menu and exiting the box, the “CONFIRM TO SAVE” Dialog box will pop up, in which you can select [YES] to confirm your selection or [NO] to give up your selection.

Warning

- All configurations in the system will be replaced by “default configurations”.

3.3 Recall

In the “SYSTEM MENU”, there are [TREND GRAPH], [TREND TABLE], [NIBP RECALL] and [ALARM RECALL] items. Please refer to Chapter 7 Recall for detailed information.

3.4 System Setup

Select the [SYS SETUP] item in the [SYSTEM MENU]:

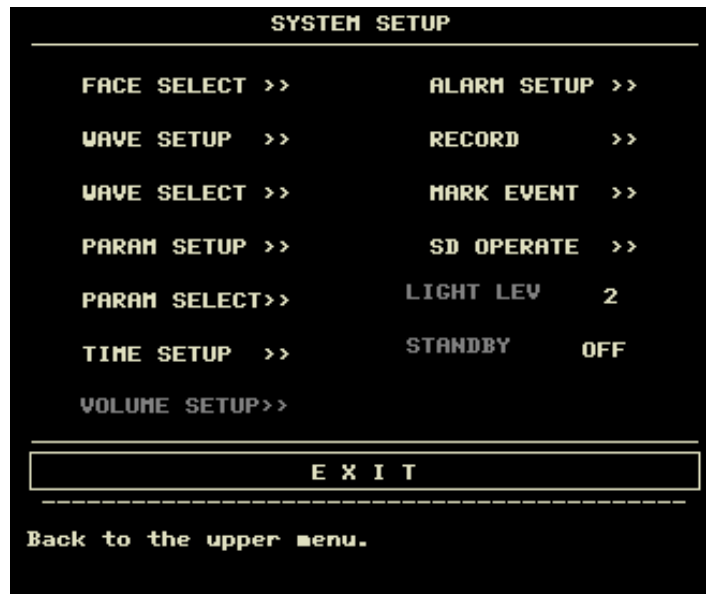

Figure 3-6 System Setup

In the [SYSTEM SETUP] menu, users can setup the following items.

3.4.1 Face Select

Select the [FACE SELECT] item in the “SYSTEM SETUP” menu to call up the following menu:



Figure 3-7 Face Select

There are five available options:

1. STANDARD SCREEN

The standard screen is the default screen. If the current screen is not the standard screen, you may enter the standard screen by selecting STANDARD SCREEN and then selecting EXIT in FACE SELECT menu.

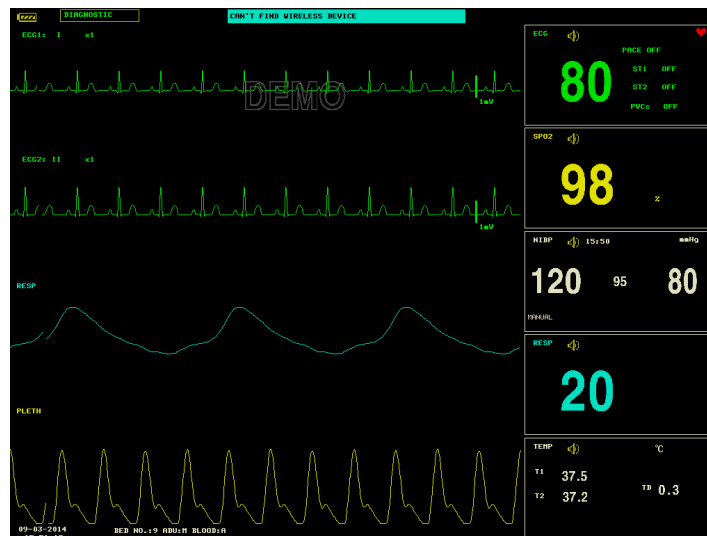

Figure 3-8 Standard

2. OxyCRG SCREEN

OxyCRG screen is located at the lower part of the waveform area, consisting of the HR trend, the SpO₂ trend, and the RR (respiration rate) trend or the compressed respiration waveform. Below the RR trend or the compressed respiration waveform is the scale of the trend time. In addition, three labels are displayed beneath the time scale. The labels are detailed as below.

① Trend length

This label allows you to select the time duration of the trend graphs displayed. You can select either 1 MIN, 2 MIN or 4 MIN.

② Compressed respiration waveform/RR trend

With this label, you can select to display the compressed respiration waveform or the RR trend beneath the SpO₂ trend.

③ Recording

You can select the REC label to print out the trends or the waveform displayed in the oxyCRG screen using the recorder.



Figure 3-9 oxyCRG

3.TREND SCREEN

■ Trend graph

Trend graphs locate to the right of the corresponding waveforms in the waveform area, and display the trends of one parameter of each module. The parameter labels, as well as their scales, are displayed to the left of the trend graph.

■ Trend length

The trend length, located below the trend graph, is 2 hours.

■ Selecting a trend parameter

If a module has multiple trend parameters, you can select one from the parameter label options of the corresponding trend graph. The trend graph of the selected parameter will be displayed. For example, in the ECG trend graph, you can select either from the parameter label options: HR, ST and PVCs.

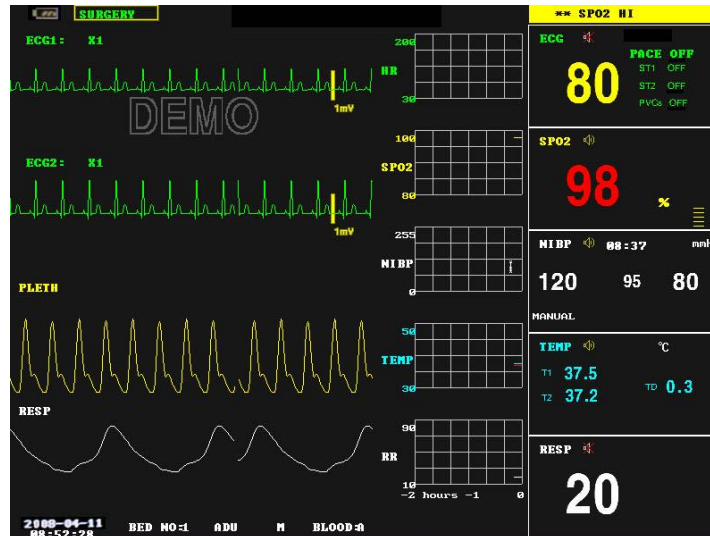

Figure 3-10 Trend

4. BIG CHAR

It can make you view parameter values more clear in a long distance.

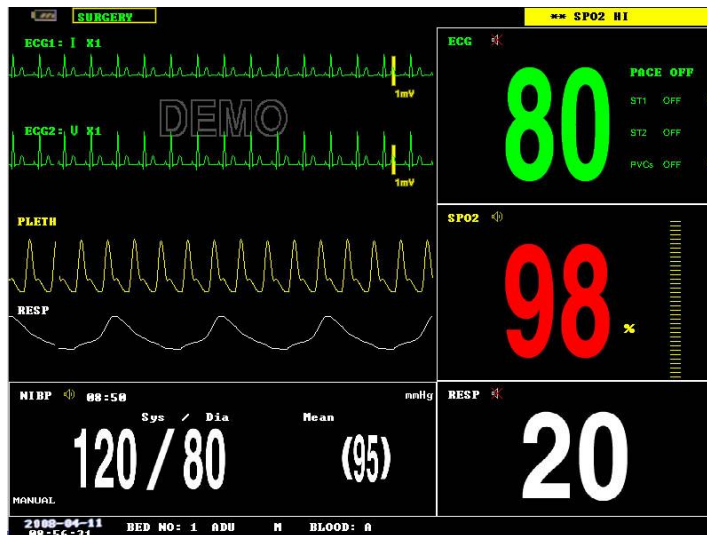

Figure 3-11 BigChar

5. VIEWBED SCREEN

This monitor can view one parameter waveform and measured data from another patient monitor (viewbed monitor) on the same monitoring network. To enter the following screen, open FACE SELECT menu, select VIEWBED SCREEN, and then select EXIT.



Figure 3-12 ViewBed Screen

The monitor you are viewing from is called “host monitor”. The monitor being viewed is called “viewbed monitor”. The viewbed screen is always displayed at the lower part of the host monitor’s waveform area. It consists of the following parts.

1. Viewbed monitor label

The viewbed monitor label allows you to select the viewbed monitor you want to view. It displays the bed number of the viewbed monitor. If the host monitor is not connected with any other monitor on the same network, the label displays N/A.

2. Viewbed parameter area

All parameter data of the viewbed monitor is displayed in this area.

3. Viewbed waveform label

The viewbed waveform label allows you to select a waveform of the viewbed monitor. If the viewbed monitor does not display any waveform, this label displays N/A.

4. Viewbed waveform area

The viewbed waveform area is located beneath the viewbed waveform label. It displays the waveform selected through the viewbed waveform label. Information relating to the viewbed waveform is shown above the waveform.

3.4.2 Wave Setup

Select the [WAVE SETUP] item in the “SYSTEM SETUP” menu to call up the following menu:

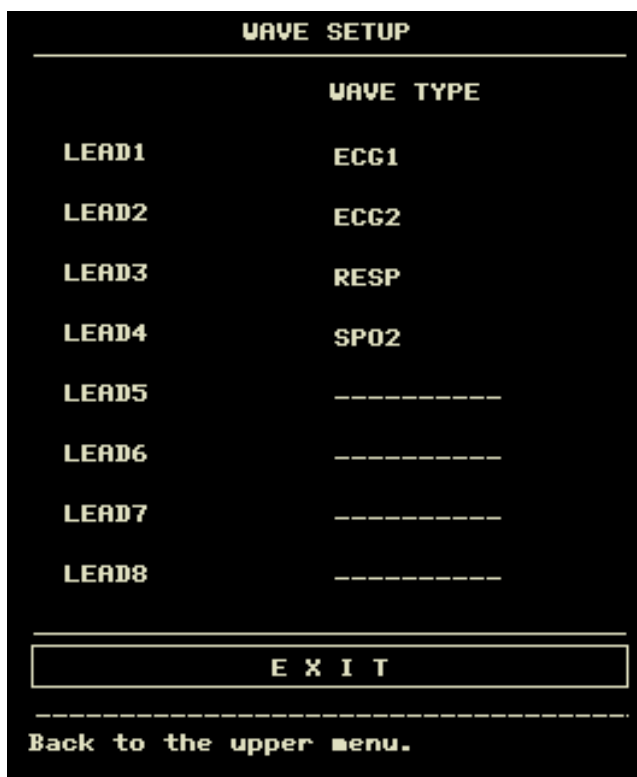

Figure 3-13 Wave Setup

You can change the waveforms position.

3.4.3 Wave Select

Select the [WAVE SELECT] in the “SYSTEM SETUP” menu to call up the following menu.



Figure 3-14 Waveform Select

3.4.4 Param Setup

Select the [PARAM SET] item in the “SYSTEM SETUP” menu to call up the following menu:

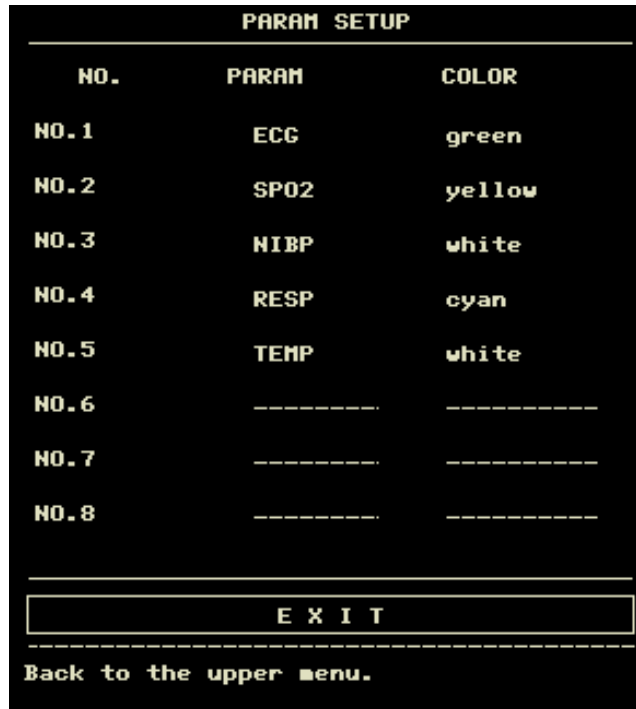

Figure 3-15 Param Setup

You can change the parameters position and display color.

3.4.5 Param Select

Select the [PARAM SELECT] item in the “SYSTEM SETUP” menu to call up the following menu:

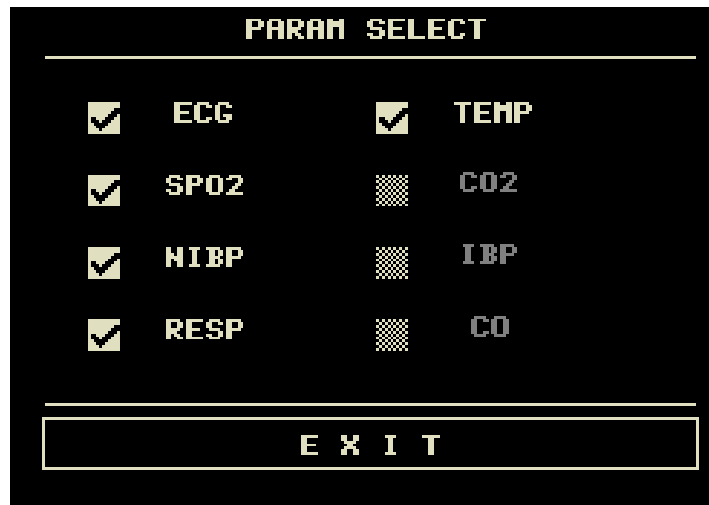

Figure 3-16 Param Select

You can choose the parameters to be monitored in this menu. This can avoid the interference from the parameters that need not attention. This function can be select only when you have ordered the corresponding optional module.

3.4.6 Time Setup

Select the [TIME SETUP] item in the “SYSTEM SETUP” menu. The menu as shown below will pop up. System time is in the format of year, month, day, hour, minute and second. Use cursor to highlight the item that you want to modify and turn the knob to select time. Then select [SAVE SET].

Note

- You shall set up the system time upon turning on the monitor (if you need to set up the system time); otherwise, when you review the content with time information, the system may not display the correct time.

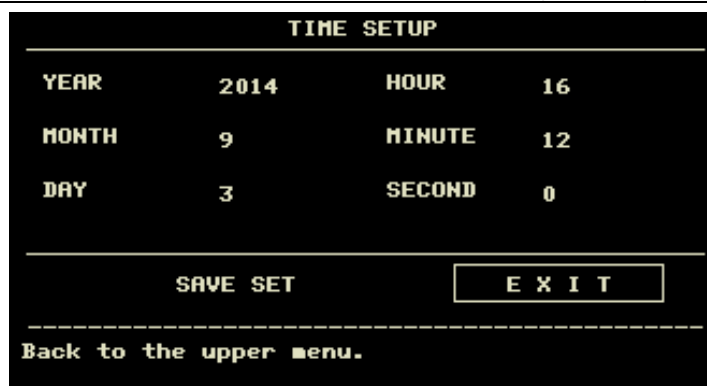

Figure 3-17 System Time Setup

3.4.7 Alarm setup

The system provides 7 levels of alarm volume. You can select any of them as per the clinical requirement. The procedures are:

Select the [ALARM SETUP] item in the "SYSTEM SETUP" sub-menu of the "SYSTEM MENU" menu. The menu as shown below will pop up, in which you can set up the alarm volume and other alarm information. For detailed information, refer to Chapter Alarm.

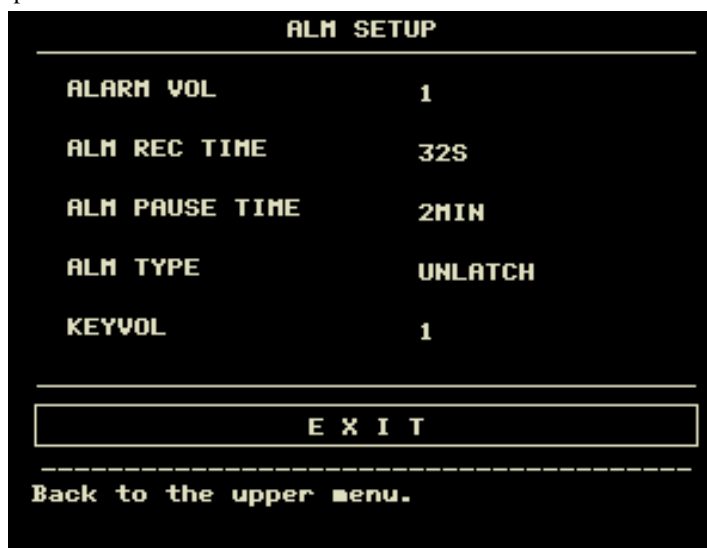

Figure 3-18 Alarm Setup

You can highlight the [ALARM VOL] item and then turn the knob to set up the alarm volume. There are 7 options:1~7.

3.4.8 Record setup

Select the [RECORD] in the “SYSTEM SETUP” menu to call up the following menu:



Figure 3-19 Record Setup

In this menu, the user can set up to output two waveforms. The waveforms that can be selected include:

ECG1-ECG2	Two ECG waveforms on the screen (If no ECG waveform is currently displayed on the screen, this item cannot be picked).
SpO ₂	SpO ₂ Plethysmogram.(If no SpO ₂ waveform is currently displayed on the screen, this item cannot be picked).
RESP	RESP waveform (If no RESP waveform is currently displayed on the screen, this item cannot be picked).
CO ₂	Displayed waveform either of anesthetic or gas or generated by CO ₂ module.
IBP1	The first IBP waveform on the screen.(If no IBP waveform is currently displayed on the screen, this item cannot be picked)
IBP2	The second IBP waveform on the screen(If less than two IBP waveforms)
OFF	No display for this waveform.

- RT REC TIME this item has two options, CONTINUAL and 8s. “CONTINUAL” means once pushing the “REC/STOP” button on the recorder panel or the monitor panel, the recorder will continuously print out the waveform or parameter until this button is pushed again.
- TIMING REC TIME OFF used to set up the time interval between two recordings. 10 selections are available: “OFF, 10min, 20min, 30min, 40min, 50min, 1hour, 2hours, 3hours and 4hours”. The system will start the recording process according to the selected time interval. The recording time is always 8 seconds.

Note

- RT REC takes priority over TIMING REC.
- REC RATE: this item has two options, 25.0 and 50.0 mm/s.
- REC GRID: used to decide output format: OFF is without grid, and ON is with grid.
- CLEAR REC TASK: used to clear the alarm event that has been generated and is waiting for recording out.
- If two same waveforms are selected, the system will automatically change one of the waveform to a different one.

3.4.9 Event Setup

The monitor has four types of events. You can specify their representations by yourself. Select the [MARK EVENT] item in the "SYSTEM SETUP" to call up the following menu:



Figure 3-20 MARK EVENT Menu

How to mark the event: Use the rotary knob to select one from event A, B, C and D. The @ symbol will appear in the frame of the event being selected. Once making a wrong selection, you can push the knob on the event again to give up the selection. Select [EXIT] to exit the menu and consequently the selection will come into effect.

Event function has following significance:

To classify the records into different categories, such as those having influence on patients and those having influence on parameter monitoring including dose taking, injection, therapy status. Event will be displayed on the trend graph/table in order to assist the analysis on the patient parameters when the event happens.

3.4.10 SD OPERATE

Please refer to chapter 7 Recall.

3.5 Monitor Version

Select the [VERSION] item in the "SYSTEM MENU" to know the software version of the monitor.

3.6 Drug Calculation

You can use the drug calculation and titration table function of the monitor to calculate the concentration of 15 kinds of drugs. Refer to Chapter: Drug Calculation and Titration Table for detailed information.

3.7 Maintenance

Select the [MAINTAIN] item in the "SYSTEM MENU" to call up the "SYSTEM MAINTAIN" dialog box as shown below, in which you can enter password and then customize maintenance settings. You cannot execute factory maintenance function, which is only available for the service engineers of our company.



Figure 3-21 Enter Maintain Password

Input the password into the "SYSTEM MAINTAIN" box and press [CONFIRM], the "USER MAINTAIN" menu will pop up, in which you can set up following items.



Figure 3-22 User Maintain Menu

- LANGUAGE :language choice.
- LEAD NAMING:AHA/EURO
- ALM SOUND:ON/OFF
- HELP SETUP:ON/OFF
- NET CONFIG:refer to 3.7.1 NET CONFIG
- KERNEL VERSION:this is used to see the kernel version when maintenance.

 **Warning**

- When the alarm volume is set to “OFF”, you will not hear the alarm sound if new alarm occurs. Therefore, you must be very careful in using this selection.
 - If setting the alarm volume to “OFF” when the system is in Silence or Pause status, the system will automatically discharge Silence or Pause status.
 - If you select “Silence” or “Pause” when the alarm volume is set to “OFF”, the system will restore the alarm volume before the alarm volume is set to “OFF” and enter Silence or Pause status.
-

Note

- After the alarm volume is set to OFF, a  symbol will appear in the Technical Alarm Area.
 - Setting Alarm Volume to “OFF” is valid only when the monitor is turned on for this time. After turning on the monitor next time, this setup will restore its value of the previous time when the system is turned on.
-

3.7.1 NET CONFIG

Press "NET CONFIG" to pop the following menu:



Figure 3-23 NET CONFIG

✧ **NET TYPE:**CMS/CUSTOM

CMS:the Server IP is fixed, "202.114.4.119", "LOCAL IP CONFIG" is unavailable.

CUSTOM:when this item is selected, CMS and machine's IP can be changed as you need.The following is "LOCAL IP SETUP" menu.

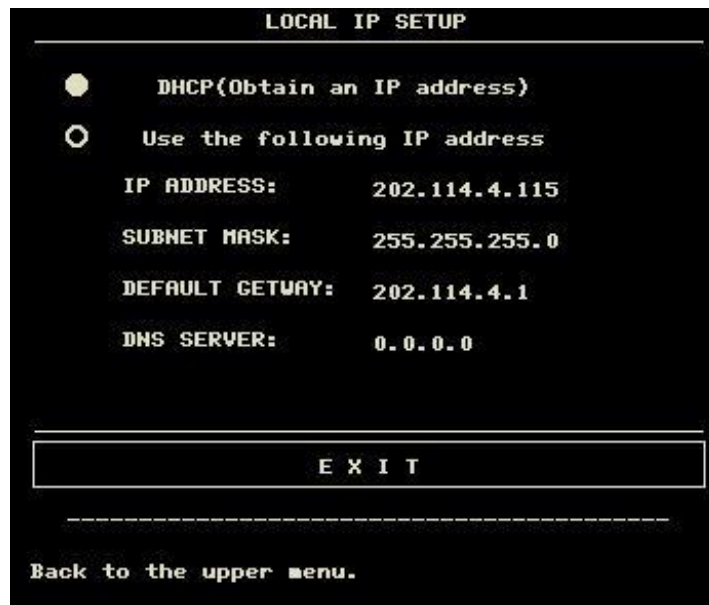

Figure 3-24 LOCAL IP SETUP

✧ **CARD TYPE:**3G,wireless and wire

3G

It is strongly required to use the accompanying 3G bracket provided by manufacturer. CDMA2000 is appointed network, but WCDMA can be ordered.

After selecting 3G network, restart the device, then the device will obtain WAN (dynamic ip, DNS, etc.) from 3G card and its driver.

Only when the net type is "CUSTOM" 3G is available.

Wireless

It is strongly required to use the accompanying wireless network card provided by manufacturer. Link router complied with IEEE802.11(ordinary or household wireless network router). Support the certification mode for WPA, WPA2 or WEP. Wireless network router links to Internet by WAN.

After selecting wireless network card, press "WIRELESS CONFIG" in "NET CONFIG" menu. "WIRELESS CONFIG" menu appears,press "SEARCH ROUTES",the following menu appears.



Figure 3-25 SEARCH ROUTE

Select corresponding router for connecting according to actual requirement, and then press "CONNECT".If connecting with safe router,enter correct password, the equipment will link to network automatically.

Wire

Wire network mode links to wire LAN complied with IEEE802.3 by RJ45 mode.LAN links to Internet by WAN.

- ✧ **LOCAL NET NO:**the physical Bed No.
- ✧ **SERVER IP:**when net type is CUSTOM ,you can change Central Monitoring System's IP.
- ✧ **LOCAL IP CONFIG:**only when the net type is "CUSTOM"this item is available.You can set the current machine's IP.Press this button to pop out "LOCAL IP SETUP"menu.
- ✧ **SELECT ROUTE:**press this item to pop "WIRELESS CONFIG"menu.

3.8 DEMO Function

Select the [DEMO] item in the "SYSTEM MENU" to call up the "INPUT DEMO KEY". After entering the password "2088", the system enters DEMO status.

The purpose of waveform demonstration is only to demonstrate the machine performance, and for training purpose. In clinical application, this function is forbidden because the DEMO will mislead the medical staff to treat the DEMO waveform and parameter as the actual data of the patient, which may result in the delay of treatment or mistreatment. Therefore before entering this menu, you shall enter password.



Figure 3-26 Input Demo Key

Chapter4 Alarm

This chapter gives general information about the alarm and corresponding remedies. Alarm setup and prompt messages are provided in respective parameter setup sections.



Warning

- **When the monitor is powered on, the system may verify the audio and visual alarm function.**
 - **Upon turning on the monitor, a “Do” will be heard and at the same time the indicator will flash once in orange. This is used to verify the audio and visual alarm function of the system. Therefore, the user should be carefully observe the status. If the audio and visual alarm function is not normal, it indicates that the monitor cannot be used to monitor a patient. Please contact our company or service center.**
-

4.1 Alarm Modes

4.1.1 Alarm Level

Each alarm, either technical or physiological, has its own level. For alarm of higher level, when it occurs, the system will give prompt in a more alert way. Some alarm’s level can be set by the user via software. Others can not be changed once defined by the system. Alarms in the monitor are divided into 7 levels, that is, high, medium and low.

High-level alarm indicates the patient’s life is in danger or the monitor under using has serious problem in technical respect. It is the most serious alarm.

Medium-level alarm means serious warning.

Low-level alarm is a general warning.

Alarms are classified into three categories, which are physiological alarm, technical alarm and general alarm. Physiological alarm refer to those alarms triggered by patient’s physiological situation which could be considered dangerous to his or her life, such as heart rate (HR) exceeding alarm limit (parameter alarms). Technical alarm refer to system failure which can make certain monitoring process technically impossible or make monitoring result unbelievable. Technical alarm is also called System Error Message. General alarm belongs to those situations that can not be categorized into these two cases but still need to pay some attention.

The monitor has preset the alarm level for the parameters. You can also modify the alarm level using the method described in this chapter.

Alarm level of the System Error Message (technical alarm) is pre-set in the system.

All technical alarm level and general alarm level, some of the physiological alarm level are pre-set in the system and can not be changed by user.

4.1.2 Alarm Modes

When alarm occurs, the monitor may raise the user’s attention in at least three ways, which are audio Prompt, visual prompt and description. Audio and visual prompt is given by TFT display device, the speaker on the display device and the alarm indicator. Description is displayed on the screen. Physiological alarm is displayed in the Physiological Alarm area. Most of technical alarms are displayed in the Technical Alarm area. Technical alarms related to NIBP measurement are displayed in the NIBP Technical Alarm area at the bottom of NIBP parameter area.

Note

- **The Physiological Alarm area is on the upper right part of the screen. The Technical Alarm area is to the left side of the Physiological Alarm area.**
 - **The concrete presentation of each alarm prompt is related to the alarm level.**
-

Screen Display

When an alarm occurs, the parameter value triggering the alarm will become red. “*” signal appears on the screen indicating the occurrence of alarm. Red “***” indicates high-level alarm, yellow “**” indicates medium-level alarm, and yellow “*” indicates low-level alarm. Technical alarm will not prompts “*” signal.

Lamp light

The high/medium/low-level alarms are indicated by the system in following different visual ways:

Alarm level	Visual prompt
High	Alarm indicator flashes in red with high frequency.

Medium	Alarm indicator flashes in yellow with low frequency.
Low	Alarm indicator lights on in yellow.

Alarm Sound

The high/medium/low-level alarms are indicated by the system in following different audio ways:

Alarm level	Audio prompt
High	Mode is “DO-DO-DO-----DO-DO, DO-DO-DO-----DO-DO”, which is triggered once every 8 seconds.
Medium	Mode is “DO-DO-DO”, which is triggered once every 8 seconds.
Low	Mode is “DO-”, which is triggered once every 8 seconds.

Note

- When alarms of different levels occur at the same time, the monitor prompts the one of the highest level.

Alarm Setup

The setup of the alarms can be realized in the alarm menu.

Press the “ALARM SETUP” button on the SYSTEM SETUP menu to call up “ALARM SETUP” menu (default menu) as shown below.



Figure 4-1 Alarm Setup

- ALARM VOL: which has 7 selections: 1~7.
- ALM REC TIME: which has three selections: 8S, 16S, 32S.
- ALM PAUSE TIME: refers to the alarm suspension time span, which has three selections: 1MIN, 2MIN, 3MIN.
- ALM TYPE:UNLATCH.UNLATCH refers to the situation that once the alarm condition is discharged, the alarm will disappear automatically.
- KEY VOL:there are 8 options:off,1~7.

4.2 Alarm Verification during Power On

During the monitor power on, audible and visual alarm capability will be tested by the system.

Every time when the monitor powers on, alarm beeps “DO-”, and the LED indicator on the display device flashes orange once. If no beeps heard or no alarm indicator flashing viewed, do not use this device to monitor any patient, and notify Customer Service Center.

4.3 Alarm Cause

Alarm occurs when:

- 1.Physiological alarm is evoked;
2. Alarm for error of the system (technical alarm) is evoked;
3. General alert occurs.

■ A. Conditions that activate the parameter alarms:

When the measurement value exceeds the alarm limit and the alarm is set to“ON”. Alarm will not activate if the alarm is set to “OFF”.

■ B. Conditions that activate the system alarms (technical alarm):

Upon the system error, the monitor prompts alarm immediately and proceeds corresponding remedy, stops all monitoring and eliminates the final results in order to avoid faulted treatment. If more than one error occur, they will be displayed by turns.

■ C. General alert

In some circumstances, alerts will behave as physiological alarm but in normal sense, we don't regard them as real patient health related items.

Note

-
- **When the sensor or probes are disconnected with the monitor, the monitor will give general prompt information. When the sensors or probes are intentionally disconnected by the operator because of inappropriate operation, the monitor will alarm with the mode of low alarm. Temporality the operator could press the button of "SILENCE", the mode of low alarm will turn to general prompt information.**
-

4.4 SILENCE and PAUSE

■ SILENCE

Press the SILENCE button on the panel for more than 1 seconds can shut off all kinds of sounds until the SILENCE button is pressed again. When the system is in SILENCE status, any newly generated alarm will discharge the SILENCE status and make the system give normal status giving audio and visual alarm.

■ PAUSE

Press the SILENCE button on the panel once to close all audio and visual prompt and description about all the physiological alarms and to make the system enter ALARM PAUSE status. The rest seconds for alarm pause is displayed in the Physiological Alarm area. And the symbol  is displayed in the System Prompt area.

The user may set up the time for Alarm Pause in the ALARM SETUP menu. Three selections are available: 1min, 2min and 3min.

When in the PAUSE status, press the SILENCE button to restore the normal alarm status. Besides, during PAUSE status, newly occurring technical alarm will discharge the PAUSE status and the system will access the normal alarm status. The  symbol disappears, too.

Note

-
- **Whether an alarm will be reset depends on the status of the alarm cause. But by pressing SILENCE button can permanently shut off audio sound of Lead Off/Sensor Off alarms.**
-

4.5 Parameter Alarm

The setup for parameter alarms is in their menus. In the menu for a specific parameter, you can check and set the alarm limit, alarm status. The setup is isolated from each other.

When a parameter alarm is off, a symbol "" displays near the parameter. If the alarms are turned off individually, they must be turned on individually.

For the parameters whose alarm is set to ON, the alarm will be triggered when at least one of them exceeds alarm limit. The following actions take place:

1. Alarm message displays on the screen as described in alarm mode;
2. The monitor beeps in its corresponding alarm class and volume;
3. Alarm lamp flashes;
4. Store all parameter values during the alarm and 4,8 or 16 second waveform prior to and after alarm.
5. If alarm recording is on, the recorder starts alarm recording. For further information on alarm recording, please refer to Chapter Recording.

4.6 When an Alarm Occurs

Note

-
- **When an alarm occurs, you should always check the patient's condition first.**
-

The alarm message appears at the top of the screen on the right side. It is needed to identify the alarm and act appropriately, according to the cause of the alarm.

1. Check the patient's condition.
2. Identify the cause of the alarm.
3. Silence the alarm, if necessary.
4. When cause of alarm has been over, check that the alarm is working properly.

You will find the alarm messages for the individual parameter in their appropriate parameter chapters of this manual.

Chapter5 Freeze

- General
- Freeze & Unfreeze
- Review & Record Frozen Waveforms

5.1 General

When monitoring a patient, you may freeze the waveforms of interest so as to view them carefully. Generally you can review maximally 34 seconds of a frozen waveform. If required, you may also use recorder to print out a frozen waveform. The Freeze function of this monitor has following features:

- Freeze status can be activated on any operating screen.
- At the same time of entering the Freeze status, the system exits all other operating menus. Besides, the system freezes all waveforms in the Waveform area of the Basic Screen, or Full-lead ECG waveforms and the extra waveform (if available) on the Full-lead ECG screen. Nevertheless the Parameter area refreshes normally.
- In the Freeze status, it does not affect the display and refresh of the Trend Graph area on the trend screen, the display and refresh of oxyCRG on the Dynamic Refresh screen, or the display and refresh of the ViewBed window on the ViewBed screen.
- The frozen waveforms can be reviewed or recorded.

5.2 Enter/Exit Freeze Status

Enter Freeze Status

In the Non-Freeze status, press the “FREEZE” button on the front panel of the monitor to let the system exit the Menu being currently displayed (if available), then enter the Freeze status and display the popup “FREEZE” menu. In the Freeze status, except ViewBed waveforms, all other waveforms are frozen. In other words, the system will no longer refresh all other waveforms.

Exit Freeze Status

In the Freeze status, executing any of the following operations will command the system to exit the Freeze status:

- Select the “EXIT” option on the “FREEZE” menu;
- Press the “FREEZE” button on the front panel again;
- Press the non-immediate-to-execute button (such as a button once pressed, a menu will pop up for you to further select an option) on the front panel and system buttons of MAIN and MENU;
- Execute any operation that may trigger the adjustment of the screen or display of a new menu.
- After exiting the Freeze status, the system will discharge the Freeze status, clear screen waveforms and resume to display real-time waveforms.

5.3 FREEZE Menu

Press the “FREEZE” button on the panel, the FREEZE menu will appear on the bottom part of the screen. At the same time, the system enters the Freeze status.



Figure 5-1 FREEZE Menu

- WAVE 1: used to select the first frozen waveform to record. The pull-down list of this item gives you the names of all frozen waveforms displayed on the screen.
- WAVE 2: used to select the second frozen waveform to record. The pull-down list of this item gives you the names of all waveforms displayed on the screen.
- RECALL: used to review frozen waveforms.
- REC: after selected, the system begins recording the frozen waveforms selected in "WAVE 1" and "WAVE 2".
- EXIT: after pressed, the system closes the FREEZE menu and exits the Freeze status.

Note

- Pressing the “FREEZE” button repeatedly in a short time may result in discontinuous waveforms on the screen.

5.4 Reviewing Frozen Waveform

By moving the waveform, you may review a waveform of 34 seconds before the moment when it is frozen. For a

waveform less than 34 seconds, the remaining part is displayed as a straight line. Use the rotary knob on the front panel to move the cursor to the “REVIEW” option on the FREEZE menu. Press the knob, the option displays “L-RIGHT”. By turning the knob left or right, frozen waveforms on the screen will move left or right correspondingly. There is an arrow indicating upward under the right side of the last waveform. There is also a time scale beside the arrow. “0S” is used to mark the moment when waveforms are frozen. With waveforms moving right, this time mark will in turn change into -1S, -2S, -3S... These time marks are applied to all waveforms on the screen.

5.5 Recording Frozen Waveform

In the Freeze status, you may output displayed frozen waveforms via the recorder. Maximum 2 waveforms can be output at one time. On the FREEZE menu, the pull-down lists of both “WAVE 1” and “WAVE 2” give you all names of frozen waveforms on the screen, from which you may select two. Select the “REC” option on the FREEZE menu to output parameters generated upon the freezing moment and the two selected frozen waveforms. If one of the two selected waveforms is closed or not available, only parameters and the other waveform are recorded. If these two selected waveforms are all closed or not available, only parameters are recorded. As for the function of recording frozen waveforms, you can only record the waveforms displayed upon the freezing moment. The recording time length is the same as the length of the waveform displayed on the screen. For example, if the speed of a waveform is relatively fast, then it needs shorter time to record it. When recording frozen waveforms, the system is still in the Freeze status. After completion of recording, if required, you may select once more the waveform to be output and select “REC” option again to record the whole selected waveforms. You may also record frozen waveforms by pressing the “REC/STOP” button on the front panel. If the recorder does not exist, selecting the “REC” option can only call out the prompt “Recorder does not exist” in the STATUS bar. For more detailed information about recording, please refer to the chapter “Recording”.

Chapter6 Recording

- General information on recording
- Instructions for configuring and recording
- Recording messages

6.1 General Information on Recording

A thermal dot matrices recorder with 48mm wide printout paper is used for the Monitor.

Performance of the Recorder

- Waveform record is printed out at a rate of 25 or 50 mm/s.
- It can record up to 2 waveforms.
- Output with grid selectable.
- English / Chinese printout.
- The real time recording time and waveform are user-configurable.
- Auto recording interval is set by the user, the waveform is in accordance with the real time recording.
- The alarm recording waveform is automatically selected by the monitor.

6.2 Recording Type

The monitor provides several stripe recording types:

- Continuous real-time recording
- 8 second real-time recording
- Auto 8 second recording
- Alarm recording
- Waveform freeze recording
- Trend graph/table recording
- ARR events review recording
- Alarm event recording
- NIBP review recording
- Monitor information recording
- Drug calculation titration recording

Real-time Recording

Real-time recording starts as you press the REC/STOP button on the recorder.

The waveforms for continuous real-time recording and continuous 8 second recording are automatically set by the monitor (usually the first two waveforms displayed on the screen). You can also configure it through the menu. Refer to related section for details.

In RECORD SETUP menu, the user can choose two waveforms to be printed out. The User can setup one waveform off. Thus, the real time record will print out one waveform. If two waveforms are off, the real time record will print out measure parameters only.

Note

If certain recording is in process, and another parameter demands alarm recording, it will only be executed after the earlier recording is finished.

Auto recording

The monitor starts the recorder for 8 seconds according to interval time set in the “TIMING REC TIME” of the “RECORD SETUP” menu. Refer to Chapter 3.4.8 Recorder Setup for details.

Alarm Recording

Parameter Alarm

The monitor records waveforms 4, 8, or 16 seconds prior to and after the alarm (totally 8, 16 or 32 seconds) (which can be selected in System Menu). All parameter values during the alarm will also be recorded.

When parameter alarm occurs, two recorded waveforms can be printed out.

In order to avoid repeated printout of alarm waveforms:

- If more than two parameter alarms are switched on and triggered simultaneously, the recorder will print out those of the highest level. If of the same alarm level, the latest alarm will be printed out.
- If an alarm occurs during the alarm of another parameter, it will be printed out after the current recording is finished.
- If many alarms occur at the same time, some of waveforms will be stored for printout in turn.

ST Segment Alarm

The monitor records 2-channel ECG waveforms 4, 8, or 16 seconds prior to and after the alarm (totally 8, 16, or 32 seconds) (which can be selected in the ECG SETUP menu). All parameter values during the alarm will also be recorded.

Arrhythmia Alarm

The monitor records 2-channel ECG waveforms 4 seconds prior to and after the alarm (totally 8 seconds). All measurement results during the alarm will also be recorded.

Freeze Waveform Recording

The monitor prints out the selected waveforms under the FREEZE mode. In this way you can snap the abnormal waveforms on the screen and record it.

Trend Graph / Table Recording

The monitor can print out the trend graph and table in the current TREND GRAPH or TREND TABLE window.

Arrhythmia Review Recording

The monitor can print out the alarm Arrhythmia event in the current ARR RECALL window.

Alarm Review Recording

The monitor can print out the alarm events include waves and parameters in the current ALARM RECALL window.

NIBP Review Recording

The monitor can print out all the NIBP review events in NIBP RECALL window.

Titration Table

The monitor can print out the messages in the current TITRATION window.

Notes on Recording

- Recording texts:
 - Real time Report
 - Periodic Report
 - Para Alarm Report: XXX (name of the alarm parameter)
 - Arrhythmia Report: XXX (Arrhythmia type)
 - Freeze Wave Report
 - Trend Graph
 - Trend Table
 - Para Alarm Review
 - NIBP Test Review
 - Titration Table
- Alarm parameters, alarm time and freeze time
- Patient bed number,sex, height, weight, date of birth, admission date
- Parameter name and value
- Recording time
- Waveform name
- Waveform scale (for ECG waveform)
- ECG lead, scale, filter mode, (if having ECG waveforms, it will be printed out within the first second or when changing the lead, gain and filter mode during real-time recording.)
- Date and time

6.3 Recording Startup

You can start the recording in the following ways:

Continuous real-time recording	Press REC/STOP to start/stop the recording.
8 second real-time recording	Press REC/STOP to start recording. It will automatically stop in 8 seconds.
Auto recording	Record the two waveforms selected in RECORD menu according to the setup time interval in RECORD menu.
Alarm recording	When alarm recording is set ON, it automatically starts when alarm occurs.
Frozen waveform recording	<p>---After accessing FREEZE menu, use knob to select two waveforms to be output. Then press REC button in the menu to print out the waveforms.</p>  <p>If two waveforms are off, the measure parameters in frozen are printed out only.</p>
Trend graph recording	Pick "REC" button in the "TREND GRAPH" menu when viewing the trend graph to print out the currently displayed tr-end graph.
Trend table recording	Pick "REC" button in the "TREND TABLE" menu when viewing the trend table to printout the currently displayed trend table.
Arrhythmia review recording	Access ARR RECALL window from ARR ANALYSIS of ECG SETUP

	menu and Pick "WAVE" button to access "ARR WAVE RECALL" menu. Then press "REC" button to output the Arr. Waveform and related information currently displayed on the screen.
Alarm review recording	Access the "ALM RECALL" window from "ALARM RECALL TIME" menu from "SYSTEM MENU" and pick "REC" button to print out the alarm review waveform and related information currently displayed in the "ALARM RECALL" window.
NIBP review recording	Access the "NIBP RECALL" window from "SYSTEM MENU" and pick "REC" button to print out the NIBP information currently displayed in the window.
Titration table recording	Access the "DRUG CALC" menu from the "SYSTEM MENU" menu. Pick the "TITRATION" button in the menu to access the "TITRATION" window. Pick the "REC" button to print out the titration currently displayed in the window.

Note

-
- You can press REC/STOP button on the recorder to stop the current recording process.
 - Access the "RECORD" menu from the "SYSTEM SETUP" menu. Then pick the "CLEAR REC TASK" button to stop all recording tasks, and clear all store of alarm.
-

6.4 Recorder Operations and Status Messages

Record Paper Requirement

Only standard 50 (+0/-1) mm thermosensitive record paper can be used, otherwise the recorder may not function, the recording quality may be poor, and the thermosensitive printhead may be damaged.

Function Properly

- When the recorder is working, the record paper goes out steadily. Do not pull the paper, or the recorder will be damaged.
- Do not operate the recorder without record paper.

Paper Out

When "RECORDER OUT OF PAPER" alarm is displayed, the recorder cannot start. Please insert record paper properly.

Inserting Paper

- Open the recorder catch.
- Insert a new roll of paper into the paper cassette, printing side facing the thermosensitive printhead.
- Give out the paper from the recorder outlet.
- Close the recorder catch.

Note

-
- Be careful when inserting paper. Avoid damaging the thermosensitive printhead. Unless when inserting paper or shooting troubles, do not leave the recorder catch open.
 - Removing Paper Jam.
 - When the recorder functions or sounds improperly, open the recorder catch to check for a paper jam. If the paper jam only re-insert the paper.
-

a) Recorder Status Message (Technical Alarms)

Message	Cause	Alarm Level	Remedy
RECORDER HEAD HOT	The thermal terminal is too hot.	Low	Stop operation
REC HEAD IN WRONG POS.	The thermal head is not in recording place.	Low	Push down the switch on the left axis of the recorder.
RECORDER OUT OF PAPER	Record paper runs out.	Low	Insert a new roll of record paper.
RECORDER COMM ERR	Operating status error	Low	Reset the recorder.
RECORDER PAPER JAM	Recording continuously for more than 30m.	Low	Re-insert paper.
RECORDER INITIALIZING	The recorder is in initialization process.	Low	Wait for the completion of initialization
TOO MANY REC TASKS	Too many alarm events take place simultaneously.	Low	Send recording order after a while.
RECORDER PAPER W.P.	The paper is in wrong position.	Low	Insert the record paper again.
RECORDER BUSY	In the status of printing out	Low	Wait for the completion of printing out
REC NOT AVAILABLE	Recorder stops working.	Low	Give recording order after the recorder restores to the normal status or the failure is removed.
RECORDER VLT HIGH	The voltage of the recorder is too high.	Low	Stop recording until the recorder restores normal status.
RECORDER VLT LOW	The voltage of the recorder is too low.	Low	Stop recording until the recorder restores normal status.
RECORDER S. COMM ERR	Unrecoverable serial port communication error.	Low	Shut down the monitor and re-start it again.
RECORDER SELFTTEST ERR	Possibly caused by the RAM, ROM, CPU or WATCHDOG.	Low	Reset the recorder.
RECORDER INIT ERR	Error occurs during initialization	Low	Shutdown and re-start
RECORDER INIT ERR1	Error occurs during initialization	Low	Shutdown and re-start
RECORDER INIT ERR2	Error occurs during initialization	Low	Shutdown and re-start
RECORDER INIT ERR3	Error occurs during initialization	Low	Shutdown and re-start
RECORDER INIT ERR4	Error occurs during initialization	Low	Shutdown and re-start
RECORDER INIT ERR7	Error occurs during initialization	Low	Shutdown and re-start
RECORDER INIT ERR8	Error occurs during initialization	Low	Shutdown and re-start

After shutdown and re-start, if error still exists, contact out service engineers.

Chapter7 Recall

The monitor provides 480-hour trend data of all parameters, storage of 4800 NIBP measurement results and 71 alarm events. This chapter gives detailed instruction for review of all data.

7.1 Trend Graph

- The latest 1-hour trend is displayed every 1 or 5 seconds;
- The latest 480-hour trend is displayed every 1, 5 or 10 minutes;

Pick "TREND GRAPH" in the SYSTEM MENU to call up the following menu:

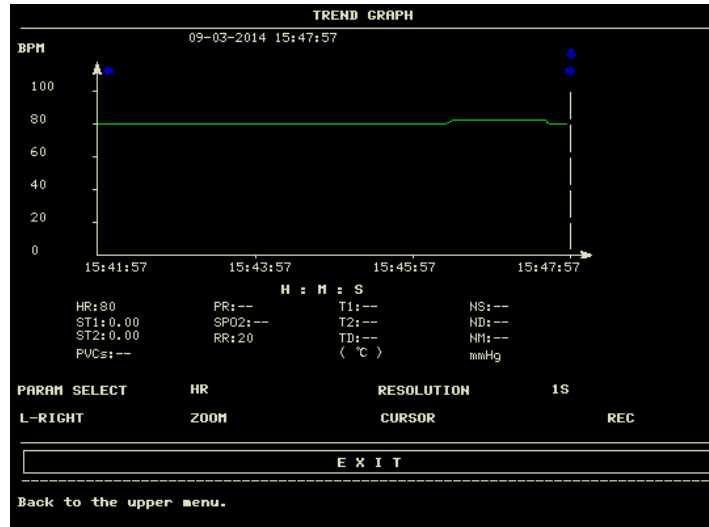

Figure 7-1 Trend Graph Menu

The uppermost part is the name of the parameter, in which y-axis stands for value and x-axis time.

"↓" Indicates the value of the parameter, which it points to, is below the x-axis, with corresponding time displayed beyond the trend graph. Other trends except NIBP trend are displayed as continuous curves. three symbols "*" indicate the position of the NIBP value, including systolic value, diastolic value, mean value.

To select trend graph of a specific parameter:

Pick PARAM SELECT item (the first selection of the upper line) and select a requested parameter name by turning the knob.

To select 1-hour or 480-hour trend graph:

Pick RESOLUTION item (the latter selection of the upper line), choose 1 or 5 sec for 1-hour trend graph and 1, 5 or 10 min for 480-hour trend graph.

To view other trend curves:

When "▶" appears on the right part of the screen, pick "L-RIGHT" (the button at the extreme left of the lower line), turn the knob clockwise to view later trend curves. When "◀" appears on the left part of the screen, pick the same item, turn the knob counterclockwise to view earlier trend curve.

To change the display scale

Pick the "ZOOM" button in the lower line to adjust the y-axis scale and thus change the trend curve in proportion. The value beyond maximum value will be represented by the maximum value.

To obtain trend data of a specific time

The time to which the cursor points will change as the knob is turned. Parameter at this time is displayed below the x-axis. When "▶" appears on the right part of the screen, the trend graph pages down for later trend curve as the cursor moves here. When "◀" appears on the left part of the screen, the trend graph pages up for earlier trend curve as the cursor moves here.

To print out the trend curve

Press REC button to print out the trend curve of current selected parameter.

Mark event

If an event is marked A, B, C, or D, then the corresponding event type will display on the axis time of the trend graph. The event sign (A, B, C or D) is displayed in a frame.

Operation example

To view the NIBP trend graph of the last 1 hour:

- Pick the MENU hot key lower right of the screen.
- Pick TREND GRAPH item.
- Pick the first item and switch to NIBP by turning the knob.
- Adjust the second item to be 1 or 5 sec.
- Pick the ZOOM button and turn the knob to view changes of the trend graph time and trend curve.
- Stop at requested trend time section for careful review. Pick the ZOOM button to adjust the display scale if necessary.
- For measurement result of a specific time, pick CURSOR to move the cursor to the point, corresponding time and value will display on above and below respectively.
- For printout of trend graph, pick REC to start report printing of NIBP trend of this hour.
- Pick EXIT to return to trend graph display.

7.2 Trend Table

- The latest 480-trend table data can be displayed at every 1, 5, 10, 30, or 60 minutes.

Pick TREND TABLE in the SYSTEM MENU to call up the following menu:

TIME	EVENT	HR (BPM)	PVCs (/min)	>
{03}15:53		80	--	
{03}15:52		80	--	
{03}15:51		80	--	
{03}15:50		80	--	
{03}15:49		80	--	
{03}15:48		80	--	
{03}15:47		80	--	
{03}15:46		83	--	
{03}15:45		80	--	
{03}15:44		80	--	
{03}15:43		80	--	
{03}15:42		80	--	

RESOLUTION: 1MIN UP/DOWN L-RIGHT REC REC ALL

EXIT

Back to the upper menu.

Figure 7-2 Trend Table Menu

Time in response to each group of trend data is displayed at the leftmost list with date in bracket. Marked event corresponds to marking time. Trend data of each parameter is divided into 8 groups.

- HR, PVCs
- ST1, ST2
- RR
- T1, T2, TD
- SpO₂, PR
- IBP1(S/D/M), IBP2(S/D/M)
- CO₂, INS, AwRR
- NIBP (S/M/D)

NIBP trend data presents different specificity. A certain NIBP measuring time is displayed below the TEST AT item, as well as the measurement value. For more than one measurement in one time, it can display only one group, and mark a "*" on the MORE to indicate two and above measurement results.

To choose trend table of different resolution

Pick the leftmost item and change the time interval of trend data.

To view other trend data:

When "↑" appears on the upper part of the screen, pick UP-DOWN button and turn the knob clockwise to view later trend data. When "↓" appears on the lower part of the screen, pick the same item and turn the knob counterclockwise to view earlier trend data.

To obtain trend data of different parameter

Pick L-RIGHT to select one from the 8 groups of parameters. A ">" by the rightmost item indicates following page available. And "<" by the leftmost item indicated previous page available.

To print out the trend data

Pick REC CUR to print out the trend data of current displayed parameter.

Mark event

If an event is marked A, B, C, or D, the corresponding event type will display on the axis time of the trend table.

Operation example

To view a NIBP trend table:

- Pick MENU button on the front panel of the monitor to access "SYSTEM MENU".
- Pick TREND TABLE.
- Pick L-RIGHT and switch to NIBP by turning the knob.
- Pick the first item from the left and select requested time interval.
- Pick UP-DOWN and turn the knob to view NIBP trend data of different time.
- For printout of trend table, pick REC ALL to start report printing of all NIBP
- Pick EXIT to return to SYSTEM MENU.

7.3 NIBP Recall

The monitor can review the latest 4800 NIBP measurement data.

Pick NIBP RECALL in the SYSTEM MENU to invoke the result and time of the latest 9 measurements, as shown in the figure below.

NIBP RECALL					
NS	NH	ND	TIME		
1	120	95	80	09-03-2014	15:50:57

NUM: 1 UNIT: mmHg UP/DOWN REC

EXIT

Back to the upper menu.

Figure 7-3 NIBP Recall

Data is listed chronologically from the latest to the earliest. 9 measurements can be displayed in one screen. Pick UP-DOWN to view other trend curve up to 4800 results. Pick REC to print out all measurement data of NIBP RECALL.

7.4 Alarm Event Recall

The monitor can display the latest 71 alarm events.

- Select "ALARM RECALL" in the SYSTEM MENU to access ALARM RECALL CONDITION menu as shown below.

ALARM RECALL CONDITION					
BEGIN TIME:					
2014	- 9	- 3	15	: 41	: 1
END TIME:					
2014	- 9	- 3	16	: 1	: 56
ALARM RECALL EVENT			ALL		
ALARM RECALL >>					
EXIT					
Back to the upper menu.					

Figure 7-4 Alarm Recall Condition Menu

In this menu, the user may select the conditions for alarm review, including:

1. Start and End time of review

The user may select the start time of review in the item of START.

Then the user may select the end time of review. Two selections are available: current time and the user-defined time. For user-defined end time, the user can use the knob to select.

2. ALARM RECALL EVENT

In the pull-down list of ALARM RECALL EVENT, the user can select the parameter whose alarm events he wants to review. The selections include ALL(alarm events of all parameters), ECG, RESP, SpO₂, NIBP, IBP,TEMP,CO₂.

After setting up all the review conditions, press the “ALARM RECALL” button to access “ALARM RECALL” window.

■ ALARM RECALL

The ALARM RECALL window is as shown below, in which following data are displayed:

- ① Time span (Format: month-day-year hour: minute- month-day-year hour: minute).
- ② Event type.
- ③ Serial number (Format: NO. xx of XX).
- ④ The value at the time of alarm. NIBP result is with time.
- ⑤ Two 8/16/32-second waveforms.

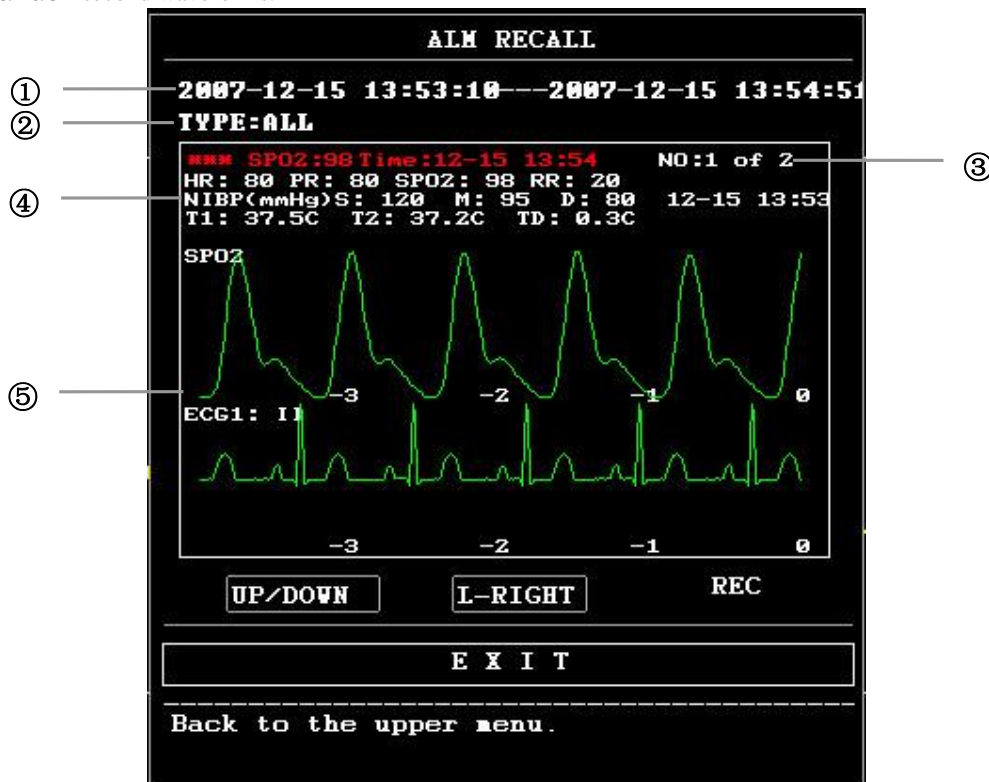

Figure 7-5 Alarm Recall Menu

To view all waveforms during the alarming process

Pick L-RIGHT and turn the knob to view all 8/16/32-second waveforms stored.

To view other alarm events

Events of up to 71 are listed chronologically from the latest to the earliest. Pick UP-DOWN button and turn the knob to view later or earlier events.

Recording

Pick REC to print out all data and waveform of this event.

7.5 SD Operate

The user can review patient data on the monitor or on PC by SD card. Here only introduce reviewing method on the monitor.

Prepare an empty SD card which capacity is at least 2G. The SD card mounted on the monitor can savetrend data respectively for HR,PVCs,ST1,SpO₂,PR,RR,T1,T2 ,TD and 72-hour waveform of ECG. The trend data's resolution is 1 minute.

Note

- Please first set the patient's information correctly before inserting SD CARD.
- Need to save different patient's data in one SD CARD, you should unmount SD CARD successfully, and then modify patient's information. Make sure that Patient No. is different.

1. Enter SD CARD OPERATE menu.

Press the key "MENU" on front panel to call up "SYSTEM MENU".



Figure 7-6 SYSTEM MENU

Select "SYS SETUP>>" in "SYSTEM MENU" to call up "SYSTEM SETUP" menu .

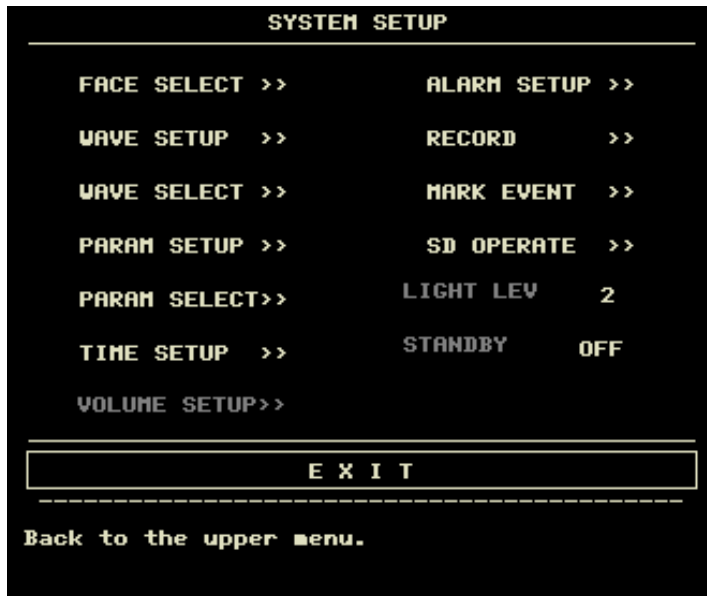

Figure 7-7 System Setup

Select "SD OPERATE>>" in the menu, "SD CARD OPERATE" menu pops up.

2. Insert SD CARD

If SD CARD has been inserted and works normal, the prompt "SD is found,please mount" appears.

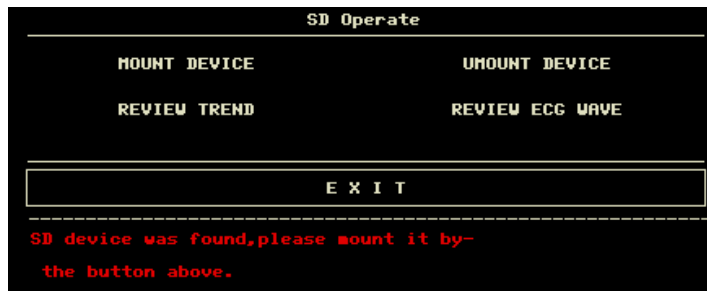

Figure 7-8 SD Card Operate

Note

- If information "SD device wasn't found,please enter SD card" will prompts, you should exit "SD CARD OPERATE" menu, check if SD CARD or USB interface is normal. If condition still exists, reboot the monitor.



Figure 7-9 SD Card Operate

3. Mount SD CARD

If the monitor has found SD CARD,press"MOUNT DEVICE",the system will display SD CARD state that if the SD CARD has been mounted successfully.

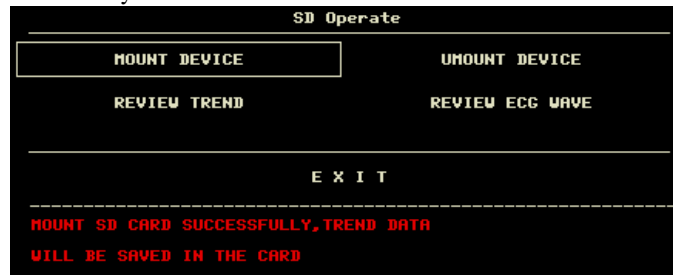

Figure 7-10 SD Card Operate

Note

- You can review trend or ECG waveform when SD CARD has been mounted successfully for 90 seconds . Otherwise the two button "REVIEW TREND" and "REVIEW ECGWAVE" are invalid.

4. Review trend

Select "REVIEW TREND" in SD OPERATE menu to call up the following menu. In this menu, you can select which patient you want to review.

```
SD CARD PATIENT NUMBER REVIEW
-----
NO.  PAT NO.  NAME      ADMIT / BIRTH
-----
1    DEF999    DFDRDGD   20130104   19630808
-----
PAGE UP  PAGE DOWN  LEFT      RIGHT     REVIEW    EXIT
```

Figure 7-11 Patient Number Review

From left to right is :list no /patient No. /patient name /admission date /birth date.

- PAGE UP/DOWN: Observe patient lists of other page
- LEFT/RIGHT: move the cursor to observe a specified patient's information
- REVIEW: press this button to call up the following menu.

5. Reading trend data's information

The menu displays the trend data's information according to the selected patient.

The first row, from left to right is:

- The current reviewed patient No.
- The patient's name
- Admission date
- Birth date

The second row, from left to right is:

- The list number
- The time that the patient data was reviewed.
- The size of data having been saved to the time that the patient data was reviewed.

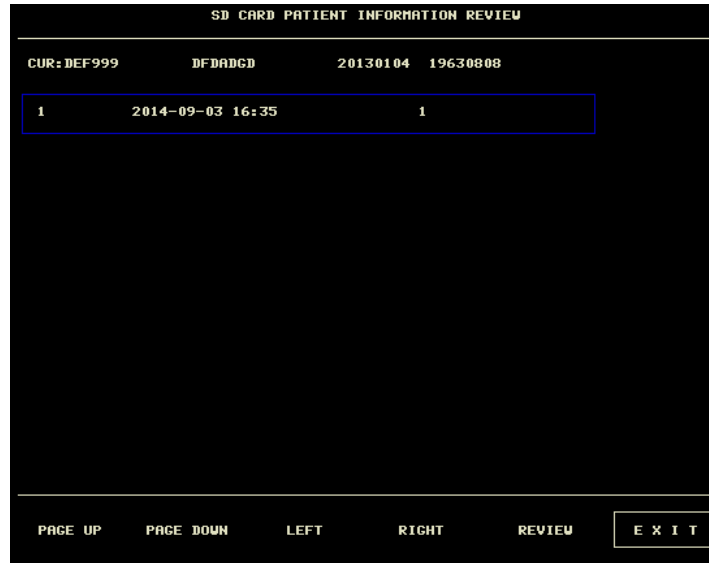

Figure 7-12 SD Card Information

6. Review trend data

Press "REVIEW" in the upper menu, the trend reviewing window pop up as Figure 7-13, you can review trend data in table way. The resolution is 1 minute.

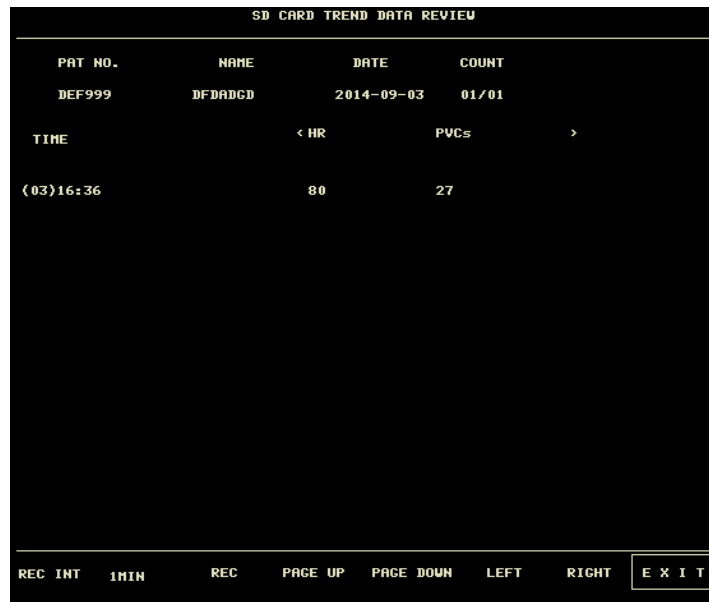

Figure 7-13 Trend Data Review

The table head is: Patient no. / Patient name /date of last reviewing SD card / (current page /sum page)

- Page UP-DOWN: press to view trend data of different time.
- L-RIGHT: press to view trend data of different parameter.
- REC(invalid).

7. REVIEW ECG WAVE

Need to review full-disclosure waveform of ECG, press "REVIEW ECG WAVE >>" in Figure 7-14, the following menu displays. In this menu, select a specified patient to review.

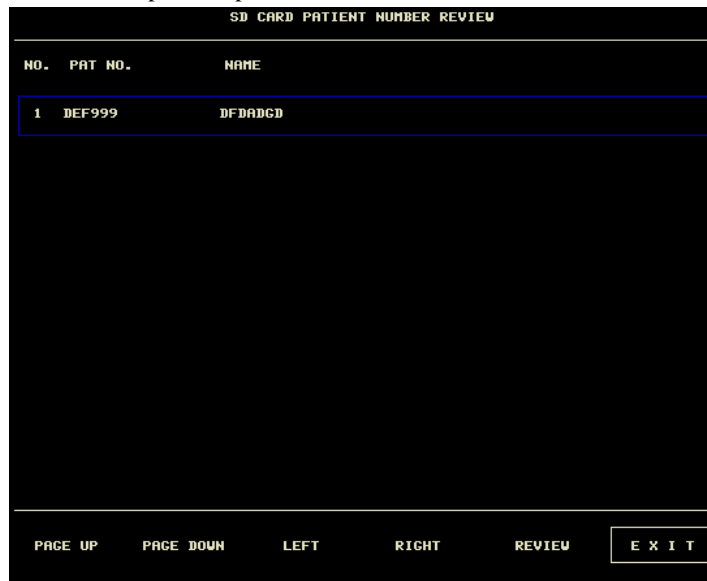

Figure 7-14 Patient Number Review

8. Select time span you want to review.

ECG data is saved in many different files. It needs to save ECG data in a new file per half an hour. "2010-12-27 13:51" represents ECG file name, it also indicates the starting time that the file is saved.

Operating to select time span:

- Want to review the ECG waveform about 2010-12-27 14:10
- By pressing cursor, select the first row "1 2010-12-27 13:51"
- Press "REVIEW".

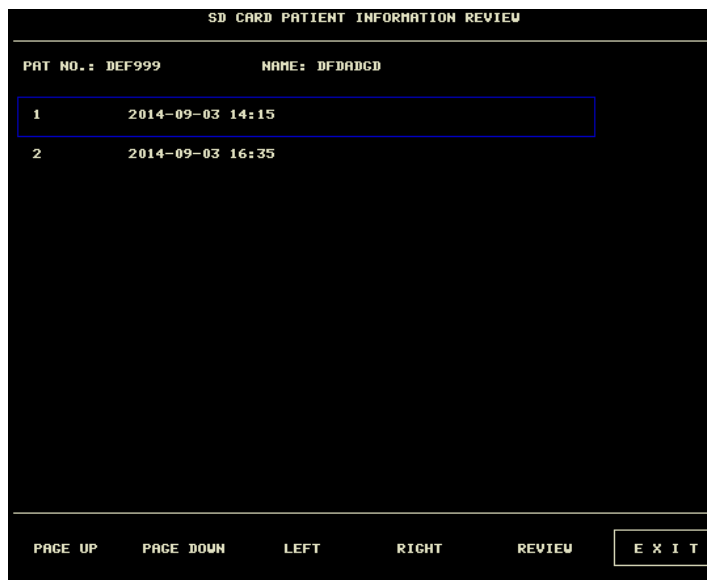

Figure 7-15 Select Time Span

9. Review ECG waveform

- The time span of one window is 5s.
- The window can display 3 channels ECG. When the lead type is 5, it displays I/II/V.

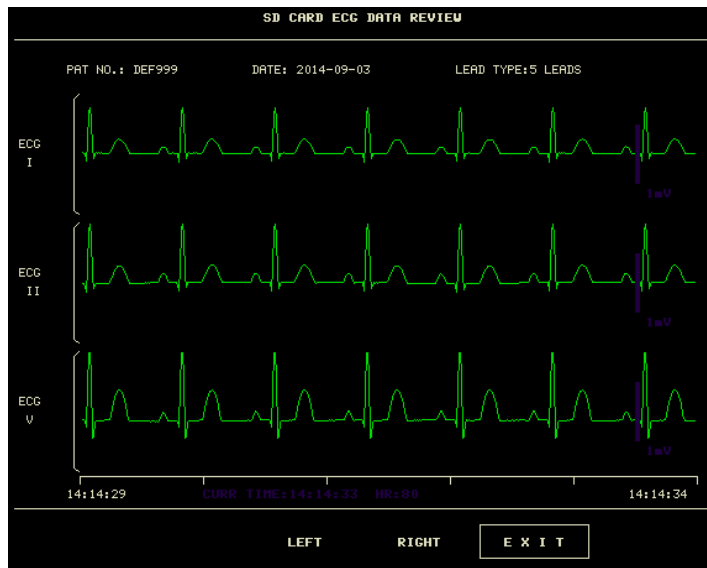

Figure 7-16 ECG Review For 5-lead

- When the lead type is 3, it can displays only one channel. The ECG lead name is the same to the one displaying on the main interface.

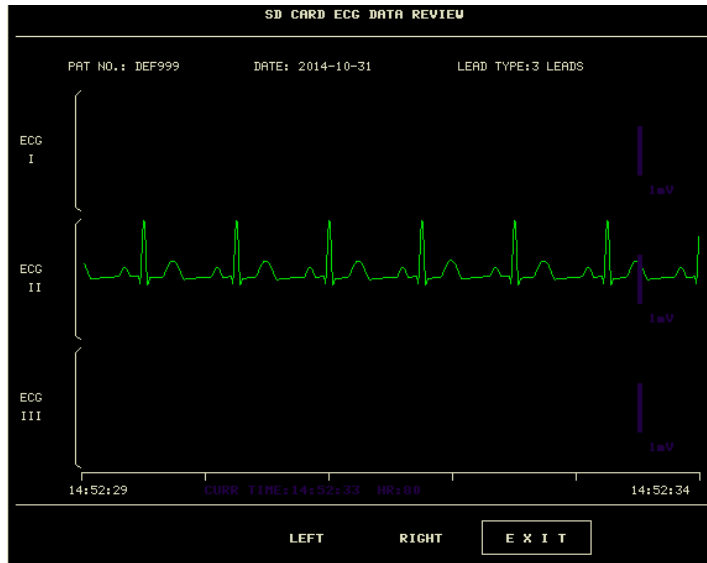

Figure 7-17 ECG Review For 3-lead

10. Unmount SD card

Enter "SD OPERATE" menu, press "UMOUNT DEVICE". You can take out SD card only when the window displays the prompt "unmount SD card successfully,you can take out the card now."

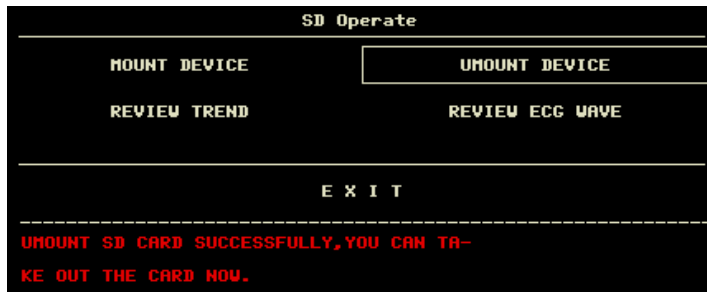

Figure 7-18 SD OPERATE

Chapter8 Drug Calculation and Titration Table

This Portable Patient Monitor provides Drug calculation and titration table display functions for fifteen drugs and outputs the content of titration table on the recorder.

8.1 Drug Calculation

The drug calculations that can be performed by the system are AMINOPHYLLINE, DOBUTAMINE, DOPAMINE, EPINEPHRINE, HEPARIN, ISUPREL, LIDOCAINE, NIPRIDE, NITROGLYCERIN and PITOCIN. Besides DRUG A, DRUG B, DRUG C, DRUG D and DRUG E are also provided to flexibly replace any of the drugs.

Select "DRUG CALC" in SYSTEM MENU, the following "DRUG CALC" display appears:

```
DRUG CALC
-----
DRUG NAME      Drug A      INF RATE      ---.--      ml/hr
WEIGHT         154.0      lb            DRIP RATE     ---.--      GTT/min
AMOUNT         ---.--      mg            DROP SIZE     ---.--      GTT/ml
VOLUME         ---.--      ml            DURATION      ---.--      hr
CONCENTRAT     ---.--      mg/ml
DOSE/min       ---.--      mcg
DOSE/hr        ---.--      mg
DOSE/kg/min    ---.--      mcg
DOSE/kg/hr     ---.--      mcg          TITRATION>>
-----
EXIT
-----
Back to the upper menu.
```

Figure 8-1 Drug CALC

The following formulas are applied for dose calculation:

Concentrat = Amount / Volume

INF Rate =DOSE/Concentrat

Duration = Amount / Dose

Dose = Rate × Concentrat

Operating method:

In the Drug Calculation window, the operator should first select the name of the drug to be calculated, and then confirm the patient weight. Afterwards, the operator should also enter other known values.

Turn the knob to select the value of the item to be calculated. Turn the knob to change the value. When it is the required value, press the knob to view the calculation result. Each item has its calculation range. If the result exceeds the range, display "---.--"

Note

- For the drug calculation, the prerequisite is that the operator must first of all enter the patient weight and drug name. The system first gives a group of random initial values, which cannot be used by the operator as the calculation reference. Instead, he should enter a new group of values at the doctor's instruction.
- Each drug has its fixed unit or unit series. Operator must select the proper unit at the doctor's instruction. If the result exceeds the system-defined range, it will display "---.--".
- After entering a value, a conspicuous prompt will appear in the menu warning the operator to confirm the correctness of the entered value. The correct value is the guarantee for the reliability and safety of the calculated results.
- In neonate mode, Drip Rate and Drop Size items are disabled.
- For each entered value, the system will always give a dialog box asking for the user's confirmation. You must be careful when answering each box. The calculated result is reliable only after the entered value is confirmed to be correct.

Select the drug name:

Turn the knob to pick the DRUG NAME item in DRUG CALC menu. The user may select the drug name in the pull-down list, including AMINOPHYLLINE, DOBUTAMINE, DOPAMINE, EPINEPHRINE, HEPARIN, ISUPREL, LIDOCAINE, NIPRIDE, NITROGLYCERIN, PITOCIN, Drug A, Drug B, Drug C, Drug D and Drug E. Calculation for only one type can be generated each time.

Note

- A,B,C,D,E are only codes for drugs instead of their real names. The units for these five drugs are fixed. The operator may select the appropriate units according to the convention of using these drugs. The rules for expressing the units are:
 - “mg” series units are fixedly used for drug A, B and C: g, mg, mcg.
 - “unit” series units are fixedly used for drug D: unit, k unit, m unit.
 - “mEq” is fixedly used for drug E.

Patient weight:

After accessing the DRUG CALC window, the operator should enter the patient weight into the first or the second item. The entered weight will be used as the independent data only for the calculation of drug concentration.

Note

- **This drug calculation function acts only as a calculator. That means the patient weight in Drug Calculation menu and the patient weight in Patient Information menu are independent from each other. Therefore if the Weight in Drug Calculation changes, the Weight in Patient Information does not change. In this way, we can say, the Drug Calculation menu is independent from other menus in the system. Any change of it will not affect other information about the patient being currently monitored.**

8.2 Titration Table

Access titration table:

Select TITRATION item in DRUG CALC menu to enter titration table display.

Titration table display for drug is as following:

TITRATION -- Drug A					
AMOUNT	400.00mg		VOLUME	250.00ml	
DOSE/min	2500.00mcg		INF RATE	93.75ml/hr	
WEIGHT	70.00kg		DRIP RATE	31.25GTT/min	
DOSE	INF RATE	DOSE	INF RATE	DOSE	INF RATE
0.00	0.00	10.00	0.38	20.00	0.75
1.00	0.04	11.00	0.41	21.00	0.79
2.00	0.08	12.00	0.45	22.00	0.83
3.00	0.11	13.00	0.49	23.00	0.86
4.00	0.15	14.00	0.53	24.00	0.90
5.00	0.19	15.00	0.56	25.00	0.94
6.00	0.23	16.00	0.60	26.00	0.98
7.00	0.26	17.00	0.64	27.00	1.01
8.00	0.30	18.00	0.68	28.00	1.05
9.00	0.34	19.00	0.71	29.00	1.09
BASIC	DOSE	STEP	1	DOSE TYPE	DOSE/min
UP-DOWN			REC		
EXIT					
Back to the upper menu.					

Figure 8-2 Titration

- Method to operate the titration table:
 1. In the TITRATION table, turn the knob to pick BASIC item. Press and turn the knob to select either INF RATE or DOSE or DRIP RATE.
 2. Then turn the knob to pick STEP item. Press and turn the knob to select step. 1 ~ 10 are available for selection with the increment being 1.
 3. Turn the knob to pick DOSE TYPE item. Press and turn the knob to select the unit in the pull-down list.
 4. Use UP-DOWN item in the table to view the data in previous or following pages.
 5. Turn the knob to pick REC item. After pressing the knob, the recorder prints out the data displayed in the current titration table.
 6. Turn the knob to pick EXIT to return to DRUG CALC menu.

Total amount, dose, volume, flow-rate, drop rate and patient weight and drug name are displayed on the top of the titration table. Meaning of each English identifier is:

- AMOUNT:drug amount
- VOLUME:liquid volume
- DOSE/min:drug dose
- INF RATE:inf rate
- DRIP RATE:drip rate
- WEIGHT:patient weight

Chapter9 Patient Safety

This Portable Patient Monitor is designed to comply with the International National Safety requirements for medical electrical equipment. This device has floating inputs and is protected against the effects of defibrillation and electrosurgery. If the correct electrodes are used and applied in accordance with the manufacturer instructions, the screen display will recover within 5 seconds after defibrillation.



This symbol indicates that the instrument is IEC 60601-1 Type CF equipment. The unit displaying this symbol contains an F-Type isolated (floating) patient applied part providing a high degree of protection against shock, and is suitable for use during defibrillation.



Warning

- **Do not touch the patient, bed or instrument during defibrillation.**
 - **Please use anti-defibrillation ECG cable during defibrillation.**
-

Environment

Follow the instructions below to ensure a completely safe electrical installation. The environment where the Monitor will be used should be reasonably free from vibration, dust, corrosive or explosive gases, extremes of temperature, humidity, and so on. For a cabinet mounted installation, allow sufficient room at the front for operation and sufficient room at the rear for servicing with the cabinet access door open.

The Monitor operates within specifications at ambient temperatures between 5°C and 40°C. Ambient temperatures that exceed these limits could affect the accuracy of the instrument and cause damage to the modules and circuits. Allow at least 2 inches (5cms) clearance around the instrument for proper air circulation.

Power Source Requirements

Refer to **chapter Production Specification.**

Grounding the Monitor

To protect the patient and hospital personnel, the cabinet of the Monitor must be grounded. Accordingly, the Monitor is equipped with a detachable 3-wire cable which grounds the instrument to the power line ground (protective earth) when plugged into an appropriate 3-wire receptacle. If a 3-wire receptacle is not available, consult the hospital electrician. If completeness of the protective grounding wire is in doubt, the equipment must be operated with internal power supply.



Warning

- **Do not use a 3-wire to 2-wire adapter with this instrument.**
-

Connect the grounding wire to the equipotential grounding terminal on the main system. If it is not evident from the instrument specifications whether a particular instrument combination is hazardous or not, for example due to summation of leakage currents, the user should consult the manufacturers concerned or else an expert in the field, to ensure that the necessary safety of all instruments concerned will not be impaired by the proposed combination.

Equipotential Grounding

Protection class 1 instruments are already included in the protective grounding (protective earth) system of the room by way of grounding contacts in the power plug. For internal examinations on the heart or the brain, the Monitor must have a separate connection to the equipotential grounding system. One end of the equipotential grounding cable (potential equalization conductor) is connected to the equipotential grounding terminal on the instrument rear panel and the other end to one point of the equipotential grounding system. The equipotential grounding system assumes the safety function of the protective grounding conductor if ever there is a break in the protective grounding system. Examinations in or on the heart (or brain) should only be carried out in medically used rooms incorporating an equipotential grounding system. Check each time before use that the instrument is in perfect working order. The cable connecting the patient to the instrument must be free of electrolyte.

 **Warning**

- **If the protective grounding (protective earth) system is doubtful, the monitor must be supplied by inner power only.**













Condensation









Make sure that during operation, the instrument is free of condensation. Condensation can form when equipment is moved from one building to another, thus being exposed to moisture and differences in temperature.

 **Warning**

- **Possible explosion hazard if used in the presence of flammable anesthetics.**

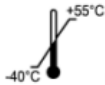
Explanation of Symbols in the Monitor

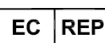
	This symbol means Refer to instruction manual/booklet
	Hazard or Warning - pay close attention
	This symbol indicates that the instrument is IEC 60601-1 Type CF equipment. The unit displaying this symbol contains an F-Type isolated (floating) patient applied part providing a high degree of protection against shock, and is suitable for use during defibrillation.
	Alternating current
	Stand-by
	USB interface
	Equipotential grounding system
	Serial number
	Date of manufacture
	Manufacturer
	WEEE (2002/96/EC)
	This way up

	<p>Fragile, handle with care</p>
	<p>Keep dry</p>
	<p>The same packing stacked up to 5-layers</p>
	<p>Atmospheric pressure limitation.</p>
	<p>Temperature limitation</p>
	<p>Humidity limitation.</p>
	<p>European Representative.</p>
	<p>This item is compliant with Medical Device Directive 93/42/EEC of June 14, 1993, a directive of the European Economic Community.</p>

Chapter10 Care / Cleaning

10.1 System Check

Before using the monitor, do the following:

- check if there is any mechanical damage;
- check all the outer cables, inserted modules and accessories;
- check all the functions of the monitor to make sure that the monitor is in good condition.

If you find any damage on the monitor, stop using the monitor on patient, and contact the biomedical engineer of the hospital or our Customer Service immediately.

The overall check of the monitor, including the safety check, should be performed only by qualified personnel once every 6 to 12 month, and each time after fix up.

You should check the synchronism of the defibrillator in the frequency described in the hospital regulations. At least every 3 months, it should be checked by a qualified customer service technician.

All the checks that need to open the monitor should be performed by qualified customer service technician. The safety and maintenance check can be conducted by persons from our company. You can obtain the material about the customer service contract from the local office.

The circuits diagrams, parts lists and calibration instructions of the monitor can be provided by the manufacturer.

Note

-
- **To ensure maximum battery life, it is recommended that, at least once a month, the monitor be run on battery until it turns itself off and then recharged.**
-
-



Warning

-
- **If the hospital or agency that is responding to using the monitor does not follow a satisfactory maintenance schedule, the monitor may become invalid, and the human health may be endangered.**
 - **Refer the battery replacement only to our service technician.**
-
-

10.2 General Cleaning



Warning

-
- **Before cleaning the monitor or the sensor, make sure that the equipment is switched off and disconnected from the power line.**
-
-

The Monitor must be kept dust-free.

Regular cleaning of the monitor shell and the screen is strongly recommended. Use only non-caustic detergents such as soap and water to clean the monitor shell.

Note

-
- **Please pay special attention to the following items:**
 1. **Avoid using ammonia-based or acetone-based cleaners such as acetone.**
 2. **Most cleaning agents must be diluted before use. Follow the manufacturer's directions carefully to avoid damaging the monitor.**
 3. **Don't use the grinding material, such as steel wool etc.**
 4. **Don't let the cleaning agent enter into the chassis of the system.**
 5. **Don't leave the cleaning agents at any part of the equipment.**
-
-

10.3 Cleaning Agents

Examples of disinfectants that can be used on the instrument casing are listed below:

- Diluted Ammonia Water
- Diluted Sodium Hypochlorite (Bleaching agent).

Note

- **The diluted sodium hypochlorite from 500ppm(1:100 diluted bleaching agent) to 5000ppm (1:10 bleaching agents) is very effective. The concentration of the diluted sodium hypochlorite depends on how many organisms (blood, mucus) on the surface of the chassis to be cleaned.**
 1. Diluted Formaldehyde 35% -- 37%
 2. Hydrogen Peroxide 3%
 3. Alcohol
 4. Isopropanol
 - **The monitor and sensor surface can be cleaned with hospital-grade ethanol and dried in air or with crisp and clean cloth.**
 - **Our company has no responsibility for the effectiveness of controlling infectious disease using these chemical agents. Please contact infectious disease experts in your hospital for details.**
-

10.4 Disinfection

To avoid long-term damage to the device, we suggest to disinfect the device only necessary during the maintenance plan. And we suggest to clean the device first before disinfection.

Advised disinfection material: ethanol group, aldehyde group

Please refer to relative chapters for the disinfection of ECG lead, SpO2 sensor, NIBP cuff and TEMP probe.

Caution

- **Do not use EtO gas or formaldehyde to disinfect the monitor.**
 - **Dilute the disinfectant according to manufacture's instruction or adopt the disinfectant with concentration as low as possible.**
 - **Do not let any liquid ingress into the device.**
 - **Do not immerse any part of the device in any liquid.**
 - **During disinfection, do not pour any liquid on the device.**
 - **Do not leave any disinfectant on the surface of device, wipe it up immediately with a wet cloth.**
-

Chapter11 ECG/RESP Monitoring

11.1 What is ECG Monitoring

Monitoring the ECG produces a continuous waveform of the patient's cardiac electric activity to enable an accurate assessment of his current physiological state. Only proper connection of the ECG cables can ensure satisfactory measurement. On the Normal Display, the monitor provides display of 2-channel ECG waveforms.

- The patient cable consists of 2 parts;
 - The cable that connects to the monitor;
 - The lead set that connects to the patient.
- Using a 5-lead set, the ECG can derive up to two waveforms from two different leads. For requested lead, you may choose from the left side of ECG waveform.
- The monitor displays the Heart Rate (HR), ST segment and Arrhythmia analysis.
- All of the parameters above can be set as alarm parameters.

Note

-
- **In the default settings of the monitor, the ECG waveforms are the first two waveforms from top in the Waveform Area.**
-

11.2 Precautions during ECG Monitoring



Warning

-
- **Do not touch the patient, table nearby, or the equipment during defibrillation.**
 - **Please use anti-defibrillation ECG cable during defibrillation.**
 - **Use only the original ECG cable for monitoring.**
 - **When connecting the cables and electrodes, make sure no conductive part is in contact with the ground. Verify that all ECG electrodes, including neutral electrodes, are securely attached to the patient.**
-

Note

-
- **Interference from a non-grounded instrument near the patient and ESU interference can cause inaccuracy of the waveform.**
-

11.3 Monitoring Procedure

11.3.1 Preparation

1. Prepare the patient's skin prior to placing the electrodes.
 - The skin is a poor conductor of electricity, therefore preparation of the patient's skin is important to facilitate good electrode contact to skin.
 - Shave hair from sites, if necessary.
 - Wash sites thoroughly with soap and water. (Never use ether or pure alcohol, because this increases skin impedance).
 - Rub the skin briskly to increase capillary blood flow in the tissues and remove skin scurf and grease.
2. Attach clip or snap to electrodes prior to placement.
3. Put the electrodes on the patient. Before attaching, apply some conductive jelly on the electrodes if the electrodes are not electrolyte self-supplied.
4. Connect the electrode lead to the patient's cable.
5. Make sure the monitor is ready with power supply.

Note

-
- **For protecting environment, the electrodes must be recycled or disposed of properly.**
-



Warning

-
- **Check everyday whether there is skin irritation resulted from the ECG electrodes. If so, replace electrodes every 24 hours or change their sites.**
-

- Verify lead fault detection prior to the start of monitoring phase. Unplug the ECG cable from the socket, the screen will display the error message “ECG LEAD OFF” and the audible alarm is activated.

11.3.2 Installing ECG lead

Placing the Electrodes for ECG Monitoring

Electrode placement for 5-lead set (Figure 11-1)

- Red (R) electrode - Be placed near the right shoulder, directly below the clavicle.
- Yellow (L) electrode - Be placed near the left shoulder, directly below the clavicle.
- Black (N) electrode - Be placed on the right hypogastrium.
- Green (F) electrode - Be placed on the left hypogastrium.
- White (C) electrode - Be placed on the chest as illustrated in the F Figure 11-2.

Note

- The following table gives the corresponding Electrode names used in Europe and America respectively. (Electrode names are represented by R, L, N, F and C respectively in Europe, whose corresponding Electrode names in America are RA, LA, RL, LL and V.)

America		Euro	
Electrode names	Color	Electrode names	Color
RA	White	R	Red
LA	Black	L	Yellow
LL	Red	F	Green
RL	Green	N	Black
V	brown	C	White

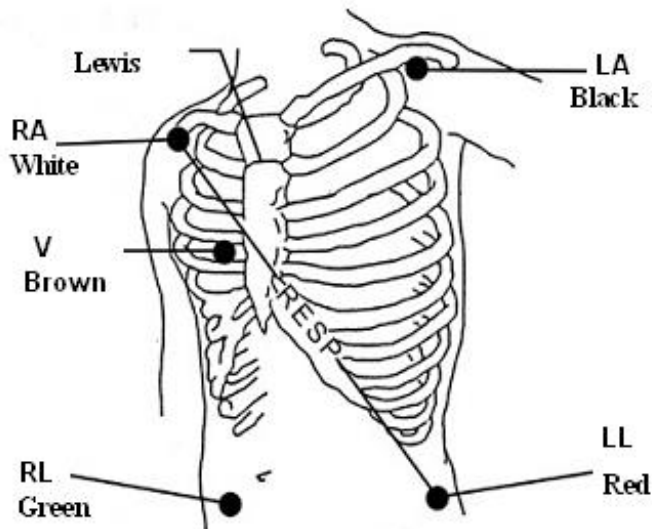

Figure 11-1 Electrode Placement for 5-lead Set

Note

- To ensure patient safety, all leads must be attached to the patient.

For 5-lead set, attach the C-electrode to one of the indicated positions as below (Figure 11-2):

- V1 On the 4th intercostal space at the right sterna margin.
- V2 On the 4th intercostal space at the left sterna margin.
- V3 Midway between V2 and V4 electrodes.
- V4 On the 5th intercostal space at the left clavicular line.

- V5 On the left anterior axillary line, horizontal with V4 electrode.
- V6 On the left middle axillary line, horizontal with V4 electrode.
- V3R-V7R On the right side of the chest in positions corresponding to those on the left.
- VE Over the xiphoid position.
- V7 On the 5th intercostal space at the left posterior axillary line of back.
- V7R On the 5th intercostal space at the right posterior axillary line of back.

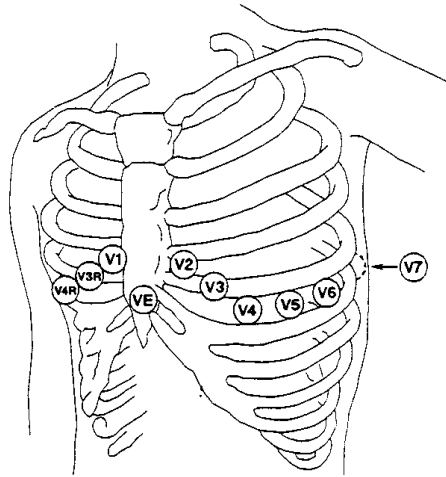

Figure 11-2 C-electrode Placement For 5-lead Set
Recommended ECG Lead Placement for Surgical Patients

The placing of the ECG leads will depend on the type of surgery that is being performed. For example, with open chest surgery the electrodes may be placed laterally on the chest or on the back. In the operating room, artifacts can sometimes affect the ECG waveform due to the use of ES (Electrosurgery) equipment. To help reduce this you can place the electrodes on the right and left shoulders, the right and left sides near the stomach, and the chest lead on the left side at mid-chest. Avoid placing the electrodes on the upper arms, otherwise the ECG waveform will be too small.

Warning

- When using Electrosurgery equipment, leads should be placed in a position in equal distance from Electrosurgery electrotome and the grounding plate to avoid cautery. Electrosurgery equipment wire and ECG cable must not be tangled up.
 - ECG cables can be damaged when connected to a patient during defibrillation. Check cables for functionality before using them again.
 - Pacemaker failure: During complete heart block or pacemaker failure to pace/capture, tall P-waves (greater than 1/5 of the average R-wave height) may be erroneously counted by the monitor, resulting in missed detection of cardiac arrest.
 - External pacing electrodes: When a pacemaker with external pacing electrodes is being used on a patient, arrhythmia monitoring is severely compromised due to the high energy level in the pacer pulse. This may result in the arrhythmia algorithm's failure to detect pacemaker non-capture or asystole.
 - During surgery: Use the special electrode ECG safety cable, for measuring ECG in the operating room. These cables have extra circuitry to protect the patient from burn and decrease electrical interference. This also reduces the hazard of burn in case of a defective neutral electrode at the HF device. These cables cannot be used for measuring respiration.
 - When using Electrosurgery equipment, never place an electrode near the grounding plate of the Electrosurgery device, otherwise there will be a great deal of interference with the ECG signal.
-

■ Using 5-lead ECG set

The default setting is ECG CH1 corresponding to Channel II, and ECG CH2 to Channel I, you can modify the setting to meet your needs. You can set them to correspond to any two from I, II, III, aVR, aVL, aVF, V. If you set both to the same value, one of them will be adjusted to another option automatically. (Figure 11-3)

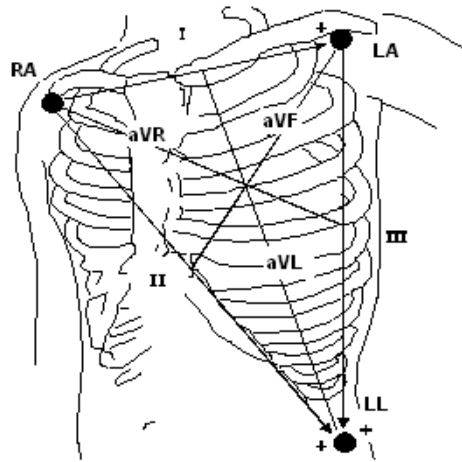

Figure 11-3 ECG Lead

Note

-
- If a ECG waveform is not accurate, while the electrodes are tightly attached, try to change the lead.
 - Interference from a non-grounded instrument near the patient and ESU interference can cause inaccuracy of the waveform.
-

Normal QRS complex should be:

- Tall and narrow with no notches.
- With tall R-wave completely above or below the baseline.
- With pacer spike no higher than R-wave height.
- With T-wave less than one-third of the R-wave height.
- With P-wave much smaller than the T-wave.

For getting 1 mv calibrated ECG wave, choose ECG CAL button in ECG SETUP menu. A message "when CAL, can't monitor!" prompts on the screen.

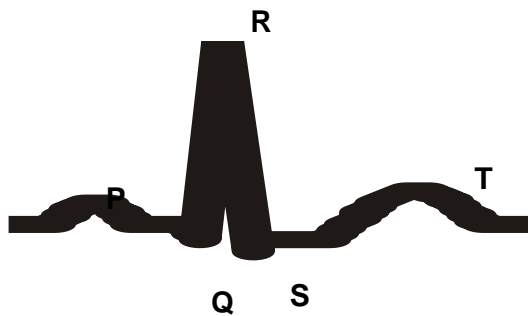

Figure 11-4 Standard ECG Waveform

Warning

- Do not touch the patient, table nearby, or the equipment during defibrillation.
-

11.4 ECG Screen Hot Keys



Figure 11-5 The Hot Key For ECG

① Leads of channel 1:

1) The selectable leads are I, II, III, aVR, aVL, aVF, V.

2) When the ECG is 5-lead, the selectable leads are: I, II, III, aVR, aVL, aVF; V. when ECG is 3-lead, the selectable leads are: I, II, III.

3) Leads on the ECG wave must not have the same name. Otherwise, the system will automatically change the ECG waveform name that has the same name as the waveform being currently adjusted to another name.

② Waveform gain of channel 1: used to adjust the size of ECG waveforms

Select gain value for each channel from $\times 0.25, \times 0.5, \times 1, \times 2, \times 4$. A 1mV scale displays on each ECG channel's one side. The height of 1mV bar is directly proportional to the waveform amplitude.

Note

- When the input signals are too large, the peak of the waveform may be not able to be displayed. In this case the user may manually change the setup method of ECG waveform according to the actual waveform so as to avoid the occurrence of the unfavorable phenomena.

③ Filter method: used for displaying clearer and more detailed waveform

There are three filter modes for selection. DIAGNOSTI, MONITOR and SURGERY modes may reduce perturbation and interference from Electrosurgery equipment. The filter method is the item applicable for both channels, which is always displayed at the waveform place of the channel 1 ECG waveform.

Note

- Only in Diagnosis mode, the system can provide non-processed real signals. In Monitor or Surgery mode, ECG waveforms may have distortion of different extent. In either of the latter two modes, the system can only show the basic ECG and the results of ST analysis may also be greatly affected. In Surgery mode, results of ARR analysis may be somewhat affected. Therefore, it is suggested that in the environment having relative small interference, you'd better monitor a patient in Diagnosis mode.

④ Leads of channel 2: refer to ① for detailed information.

⑤ Waveform gain of channel 2: refer to ② for detailed information.

Note

- Pacemaking signal detected is marked by a "|" above the ECG waveform.

11.5 ECG Menu

11.5.1 ECG SETUP Menu

Pick the ECG hot key on the screen, and the following menu will popup.

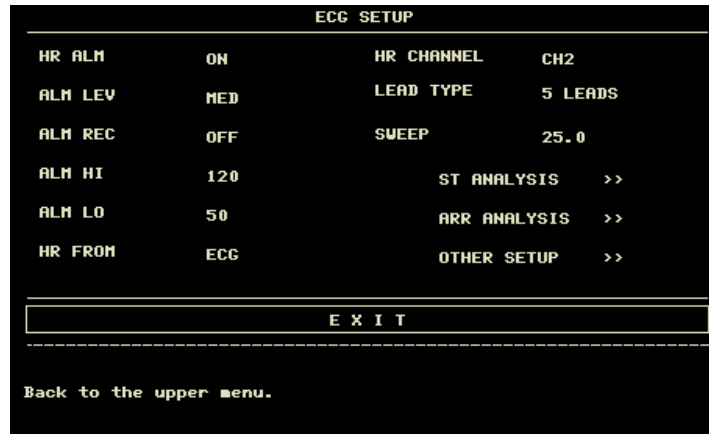



Figure 11-6 ECG Setup Menu

ECG alarm setting

- HR ALM: pick "ON" to enable prompt message and data record during the ECG alarm; pick "OFF" to disable the alarm function, and there will be a  beside "ECG".
- ALM LEV: selectable from HIGH, MED, LOW. Level HIGH represents the most serious case.
- ALM REC: pick "ON" to enable report printing upon ECG alarm.
- ALM HI: used to set up the upper limit of ECG alarm.
- ALM LO: used to set up the lower limit of ECG alarm.

ECG alarm is activated when the heart beat exceeds set ALM HI value or falls below ALM LO value.

HR alarm range:

Patient Type	MAX. ALM HI	MIN. ALM LO	Step
ADU	300	15	1
PED/NEO	350	15	1

Note

- **Please set the alarm limits according to clinical condition of individual patient. The upper limit shall not exceed 20 beat/min higher than the patient's heart rate.**

■ HR FROM

ECG, SpO₂, AUTO and BOTH may detect heart rate. AUTO distinguishes heart rate source according to the quality of signal. By picking ECG, the monitor prompts HR and activates HR beep. By picking SpO₂, the monitor prompts PULSE and activates pulse beep. BOTH mode displays HR and PR simultaneously, when this item is picked, PR parameter is displayed to the right side of SpO₂. As for the sound of HR or PR in BOTH mode, HR is given the priority, i.e., if HR is available, whose sound will be sent out, but if HR is not available, then the sound will be for PR.

■ HR CHANNEL

"CH1" to count the heart rate by CH 1 waveform

"CH2" to count the heart rate by CH 2 waveform

"AUTO" the monitor selects a channel automatically

■ LEAD TYPE: used to select either 5 LEADS or 3 LEADS.

■ SWEEP

Available options for ECG SWEEP are 12.5, 25.0, and 50.0 mm/s.

■ ST ANALYSIS

Pick this item to access ST ANALYSIS menu, the detailed information about the menu is to be discussed in the following section.

■ ARR ANALYSIS

Pick this item to access ARR ANALYSIS menu, the detailed information about the menu is to be discussed in the following section.

■ OTHER SETUP

Pick this item to access ECG SETUP menu as shown below:

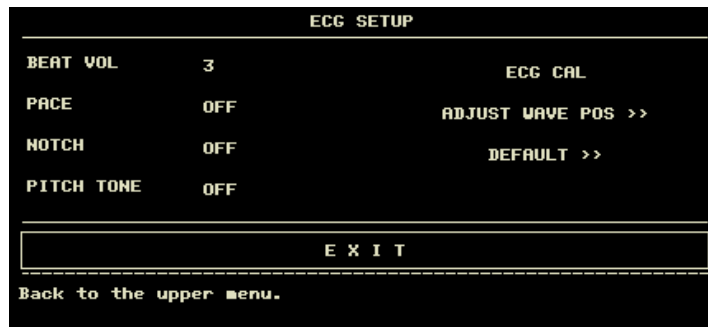

Figure 11-7 ECG Setup Menu

In the sub-menu, following functions are available:

- BEAT VOL

8 selections are available: OFF, 1~7. 7 indicates maximum volume. OFF indicates no sound.

- PACE

"ON" detected signal will be marked by a "|" above the ECG waveform

"OFF" for non-pacemaking patient

Note

- If monitoring a patient with the pacemaker, set "PACE" to On. If monitoring a patient without pacemaker, set "PACE" to Off.
- If "PACE" is on, the system will not perform some types of ARR analysis. For detailed information, please refer to the section: ARR ALARM. In the table, the ARR type marked by All types applies to the analysis in all situations, marked by Non-paced applies only to the analysis in the situation when the patient does not use pacemaker.

- NOTCH:ON/OFF.
- PITCH TONE:ON/OFF.
- ECG CAL: pick this item to start calibrating ECG. The method to end CAL: re-select the CAL key in the menu or re-select the lead name on the screen.
- DEFAULT: pick this item to access the ECG DEFAULT CONFIG dialog box, in which the user may select whether the FACTORY DEFAULT CONFIG or the USER DEFAULT CONFIG is to be used. After selecting any of the items and exiting the dialog box, the system will pop up the dialog box asking for the user's confirmation.

Warning

- For pacemaker patient, the pacing impulse analysis function must be switched on, otherwise, the pacing impulse may be counted as normal QRS complex, which results in failure of "ECG LOST" error detection. Do not rely entirely upon rate meter alarms. Keep pacemaker patients under close surveillance.

Note

- When calibrating ,Please set the filter way to "Diagnosis".
- For monitor with ST segment & Arrhythmia analysis software, refer to ST Segment Monitoring and Arrhythmia Analysis for details.
- When Pacer Switch is On, the Arrhythmia events related to PVCs will not be monitored. At the same time, the ST analysis will not be performed either.

11.6 ECG Alarm Information and Prompt

11.6.1 Alarm Message

Alarms occurring in the process of ECG measurement contain two types: physiological alarm and technical alarm. Prompt message may also appear in the mean time. For the audio and visual features during the appearance of these alarms and prompt messages in the process of ECG measurement, please refer to the related description in Chapter Alarm. In the screen, physiological alarm messages and the prompt messages able to trigger alarms (general alerts) all

displayed in the alarm area of the monitor while technical alarms and prompt messages unable to trigger alarms are then displayed in the information area of the monitor. This section does not describe the content about Arr. and ST analysis.

Among physiological alarms, those belonging to the type that the parameter has exceeded the limits may activate the recorder to automatically output the parameters and related measured waveforms when the alarms occur on the condition that the alarm record switch in the related menu is On.

Tables below describe respectively the possible various alarms those may occur during the measurement.

Physiological alarms:

Message	Cause	Alarm level
ECG LOST	No ECG signal of the patient is detected.	HIGH
HR TOO HIGH	HR measuring value is above the upper alarm limit	User-selectable
HR TOO LOW	HR measuring value is below the lower alarm limit	User-selectable

Technical alarms:

Message	Cause	Alarm level	Remedy
ECG LEAD OFF	ECG electrodes fall off the skin or ECG cables fall off the monitor.	LOW	Make sure that all electrodes, leads and patient cables are properly connected.
ECG V LEAD OFF or ECG C LEAD OFF			
ECG LL LEAD OFF or ECG F LEAD OFF			
ECG LA LEAD OFF or ECG L LEAD OFF			
ECG RA LEAD OFF or ECG R LEAD OFF			
ECG INIT ERR	ECG module failure	HIGH	Stop using measuring function provided by ECG module, notifies biomedical engineer or Our service staff.
ECG INIT ERR1			
ECG INIT ERR2			
ECG INIT ERR3			
ECG INIT ERR4			
ECG INIT ERR5			
ECG INIT ERR6			
ECG INIT ERR7			
ECG INIT ERR8			
ECG COMM STOP	Occasional communication failure	HIGH	If failure persists, notify biomedical engineer or Our service staff.
ECG COMM ERR	Occasional communication failure	HIGH	If failure persists, notify biomedical engineer or Our service staff.
HR ALM LMT ERR	Functional safety failure	HIGH	Stop using HR alarm function, notify biomedical engineer or Our service staff.
ECG NOISE	ECG measuring signal is greatly interfered.	LOW	Make sure the patient is quiet, the electrodes are properly connected and AC power system is well grounded.

Prompt messages (include general alerts):

Message	Cause	Alarm Level
HR EXCEED	HR measuring value exceeds the measurement range.	HIGH

11.7 ST Segment Monitoring

11.7.1 ST Segment Monitoring

■ The ST algorithm has been tested for accuracy of the ST segment data. The significance of the ST segment

changes needs to be determined by a clinician.

- ST segment monitoring function is shutoff by default. You can switch it to ON when necessary.

Note

- **When setting ST ANALYSIS on, the monitor will select “DIAGNOSTIC” mode. You can set it to “MONITOR” mode or “OPERATE” mode as required. However at this time ST value has been severely distorted.**

- It is available to measure the variance of ST segment with ST analysis at the waveform tracks for selected lead. The corresponding ST measurement result displays numerically at ST1 and ST2 in the Parameter Area. The trend can be viewed with table or graphic form.

- Measurement unit of ST segment: mV.

- Measurement symbol of ST segment: "+" = elevating, "-" = depressing.

- Measurement range of ST segment: -2.0 mV, ~ + 2.0 mV.

Pick the ST ANALYSIS item in the ECG SETUP menu to access the ST ANALYSIS sub-menu as shown below.

ST ANALYSIS menu

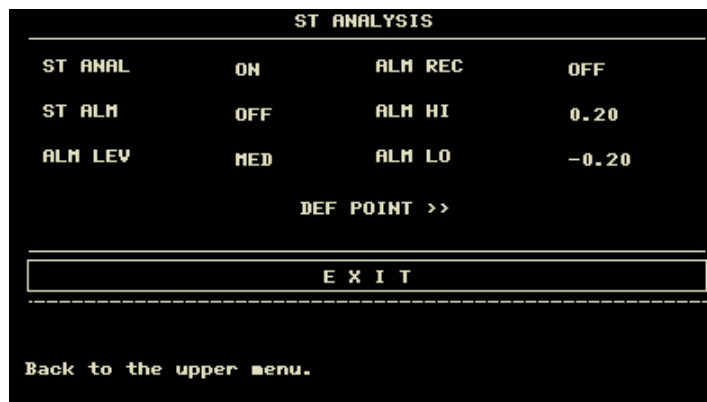



Figure 11-8 ST Analysis Menu

ST analysis alarm setting

- ST ANAL: the switch for ST analysis. Set it to ON to activate the ST analysis or OFF to disable the ST analysis.
- ST ALM: pick "ON" to enable prompt message and data record during the ST analysis alarm; pick "OFF" to

disable the alarm function, and there will be a  beside ST. ST alarm is activated when the result exceeds set ST HI value or falls below ST LO value.

- ALM LEV: used to set up the ST alarm level. There are three selections: HIGH, MED and LOW.
- ALM REC: pick "ON" to enable report printing upon ST analysis alarm.
- ALM HI: used to set up the upper limit of ST alarm. The max. higher limit is 2.0. The minimum higher limit is 0.1 larger than the set lower limit.
- ALM LOW: used to set up the lower limit of ST alarm. The minimum lower limit is -2.0. The max. lower limit is 0.1 lower than the set higher limit.

ST analysis alarm limits:

	Max. ST HI	Min. ST LO	Step
ST	2.0 mV	-2.0 mV	0.1

- DEF POINT pick this item to access the DEF POINT window, in which the position of ISO and ST point can be set up.

- ISO Base point.
- ST Measurement point.

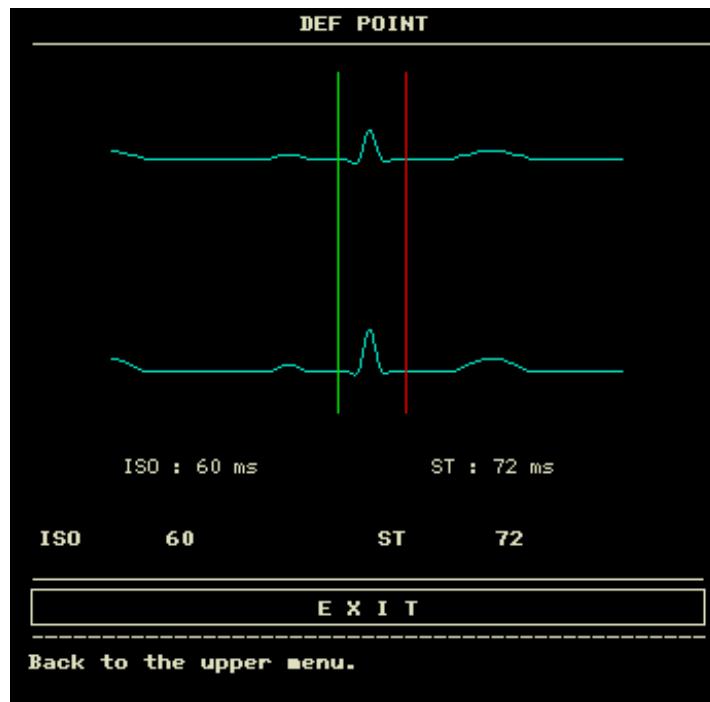

Figure 11-9 DEF Point Window

The operator can adjust the position of both ISO and ST measurement points.
The reference point is the position where the peak of R-wave locates (see Figure 11-10).

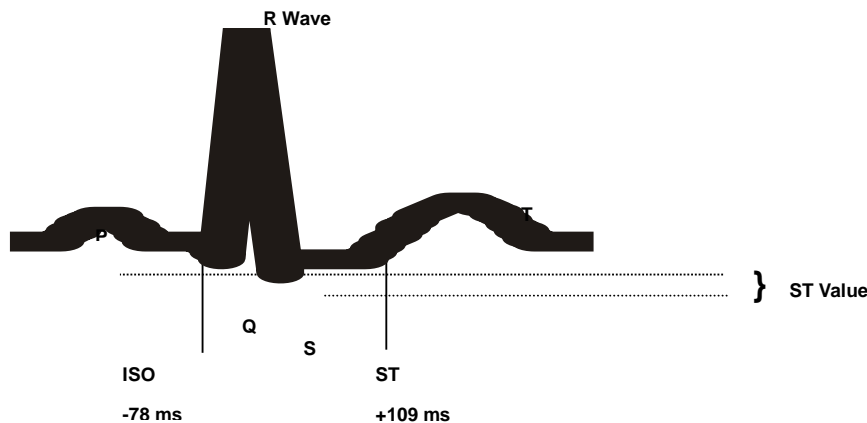

Figure 11-10 DEF Point

The ST measurement for each beat complex is the vertical difference between the two measurement points.

Note

- The ST measurement point should be adjusted if the patient's HR or ECG morphology changes significantly.

□ Adjusting ISO, ST

These two points can be adjusted turning the knob.

When adjusting ST measurement point, the system will show the ST Measurement Point Window. The QRS complex template displays in the window (If the template is not established, a horizontal line will display. If the channel is not at ON position, a horizontal line will also display). It is adjustable of the highlight bar in the window. You may select ISO or ST, then switch the knob left or right to move the cursor line. When the cursor is at the required position, you may select the base point or the measurement point.

Note

- Abnormal QRS complex is not considered in ST segment analysis.

- **ST Alarm Message**
- **The alarm limits for two ST measurements are identical. No setting of alarm limits can be made only for one channel.**

Among physiological alarms, those belonging to the type that the parameter has exceeded the limits may activate the recorder to automatically output the parameters and related measured waveforms when the alarms occur on the condition that the alarm record switch in the related menu is On.

Tables below describe the possible physiological alarms, technical alarms and prompt messages during ST measurement.

Physiological alarms:

Message	Cause	Alarm Level
ST1 TOO HIGH	ST measuring value of channel 1 is above the upper alarm limit.	User-selectable
ST1 TOO LOW	ST measuring value of channel 1 is below the lower alarm limit.	User-selectable
ST2 TOO HIGH	ST measuring value of channel 2 is above the upper alarm limit.	User-selectable
ST2 TOO LOW	ST measuring value of channel 2 is below the lower alarm limit.	User-selectable

Technical alarms:

Message	Cause	Alarm Level	Remedy
ST ALM LMT ERR	Functional safety failure	HIGH	Stop using ST alarming function, notify biomedical engineer or Our service staff.

Prompt messages (include general alerts):

Message	Cause	Alarm Level
ST1 EXCEED	ST measuring value of channel 1 exceeds the measurement range.	HIGH
ST2 EXCEED	ST measuring value of channel 2 exceeds the measurement range.	HIGH

11.8 Arr. Monitoring

11.8.1 Arrhythmia Analysis

The arrhythmia algorithm is used to monitor ECG of neonate and adult patient in clinical, detect the changing of heart rate and ventricular rhythm, and also save arrhythmia events and generate alarming information. Arrhythmia algorithm can monitor paced and non-paced patients. Qualified personnel can use arrhythmia analysis to evaluate patient's condition (such as heart rate, PVCs frequency, rhythm and ectopic beat) and decide the treatment. Besides detecting changing of ECG, arrhythmia algorithm can also monitor patients and give proper alarm for arrhythmia.

- The arrhythmia monitoring is shutoff by default. You can enable it when necessary.
- This function can call up the doctor's attention to the patient's heart rate by measuring and classifying the arrhythmia and abnormal heart beat and triggering the alarm.
- The monitor can conduct up to 13 different arrhythmia analyses.
- The monitor can store the latest 60 alarm events when taking arrhythmia analysis to a peculiar buffer. The operator can edit these arrhythmia events through the menu below.

Pick the item ARR ANALYSIS in ECG SETUP menu to access the ARR ANALYSIS sub-menu.

ARR ANALYSIS Menu



Figure 11-11 ARR Analysis Menu

- ARR ANAL: Pick "ON" during monitoring. Default set is "OFF".
- PVCs ALM: pick "ON" to enable prompt message and data record when alarm occurs; pick "OFF" to disable the

alarm function, and there will be a  beside "PVCs".

- ALM LEV: selectable from HI, MED, LO. Level HIGH represents the most serious case.
- ALM REC: pick "ON" to enable report printing upon PVCs alarm.
PVCs alarm is activated when the PVCs exceeds set PVCs ALM HI value.

PVCs alarm upper limits:

	Max	Min	Step
PVCs	30	0	1

PVCs alarm and prompt message:

Among physiological alarms, those belonging to the type that the parameter has exceeded the limits may activate the recorder to automatically output the parameters and related measured waveforms when the alarms occur on the condition that the alarm record switch in the related menu is On.

Tables below describe the possible physiological alarms, technical alarms and prompt messages occurring during pvc measurement.

Physiological alarms:

Message	Cause	Alarm Level
PVCs TOO HIGH	PVCs measuring value is above upper alarm limit.	User-selectable

Technical alarms:

Message	Cause	Alarm Level	Remedy
PVCs ALM LMT ERR	Functional safety failure	HIGH	Stop using PVCs alarming function, notify biomedical engineer or Our service staff.

- ARR RELEARN Pick this item to start a learning procedure.(unusable)
- ARR ALARM Pick this item to access the ARR ALARM dialog box to set arrhythmia alarm parameters.

Set ALM to ON/OFF to enable/disable the alarm function; Set REC to ON/OFF to enable/disable alarm record function, turn the knob under LEV column to set alarm level to HIGH, MED or LOW.

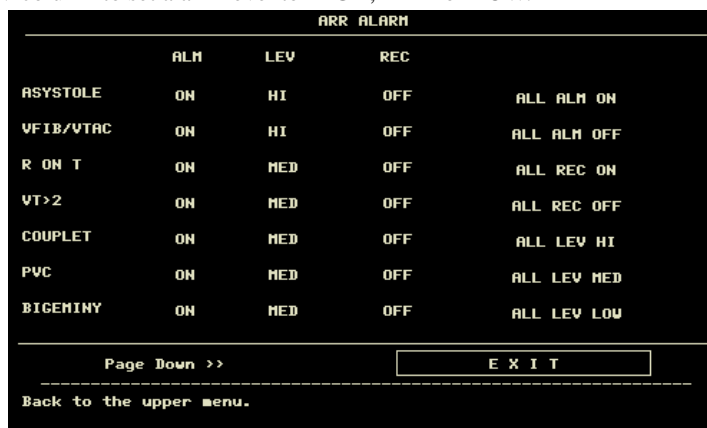

Figure 11-12 ARR Alarm Menu

You can pick ALL ALM ON to enable alarm function of all arrhythmia types and pick ALL ALM OFF to disable this function. Likewise, you can pick ALL REC ON to enable recording function for all arrhythmia types and pick ALL REC OFF to disable this function. Changing the ALM LEV can reset alarm level of all arrhythmia types to the same value.

- ARR RECALL Pick this item to review and edit the ARR analysis result.
The latest arrhythmia events (up to 60) are displayed.

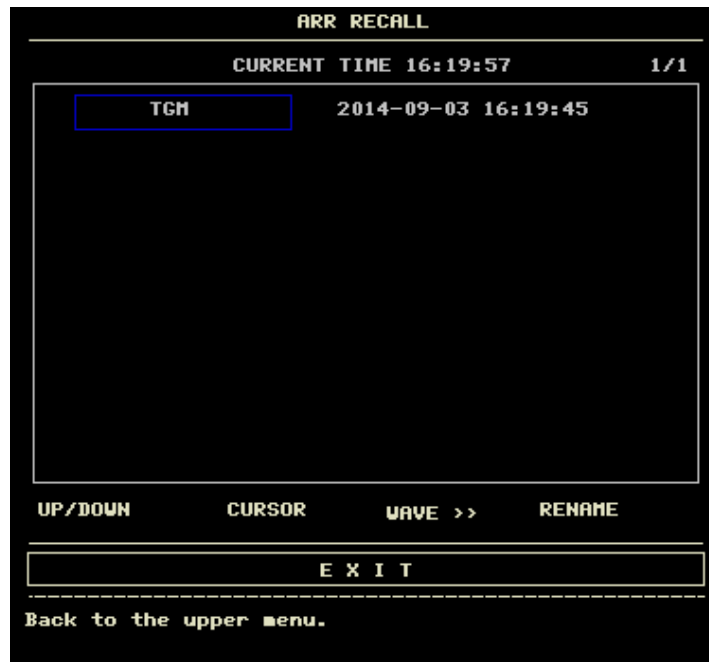

Figure 11-13 ARR Recall Menu

- UP-DOWN Observe other event lists of other page.
- CURSOR Select the Arr. event, whose name is displayed in a protruding frame.
- RENAME Rename the selected Arr. event, whose name is displayed in a sunken frame.
- WAVE Switch the knob until the name you want appears.
- WAVE To display the Arrhythmia waveform, time and parameter value.
 - UP-DOWN To observe waveforms of other Arrhythmia events.
 - RECORD To print out displayed Arrhythmia event.
 - EXIT To return to ARR RECALL menu of Arrhythmia event.

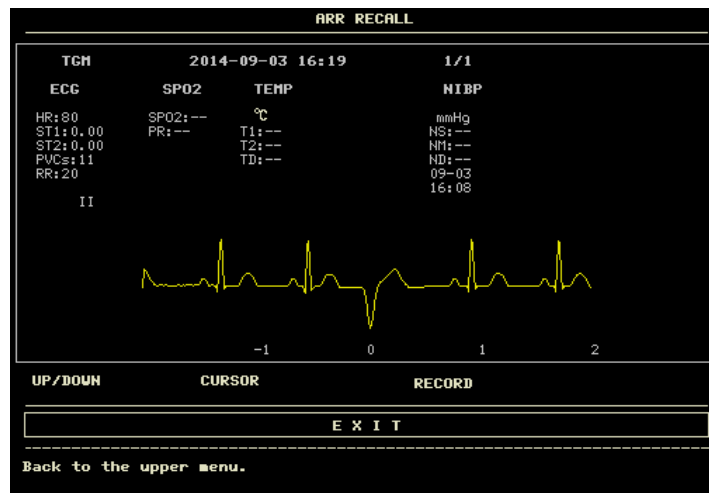

Figure 11-14 ARR Wave Recall Menu

Note

-
- If there are more than 60 Arrhythmia events, the latest will be retained.
-

ARR ALARM

The alarm is triggered when an Arrhythmia occurs. If the ALM is ON, the alarm sounds and the alarm indicator flashes. If the REC is ON, the alarm record will be printed out (4 seconds prior to and after the alarm, with the ECG waveforms of analysis channel).

Physiological alarms:

Prompt	Applicable Patient Type	Occurring Condition	Alarm Level
ASYSTOLE	All patients	No QRS is detected for 4 consecutive seconds	User-selectable
VFIB /VTAC	Without pacemaker	Fibrillatory wave for consecutive 4 seconds; or The number of continuous Vent beats is larger than the upper limit of cluster Vent beats (≥ 5). The RR interval is less than 600ms.	User-selectable
VT>2	Without pacemaker	$3 \leq$ the number of cluster PVCs < 5	User-selectable
COUPLET	Without pacemaker	2 consecutive PVCs	User-selectable
BIGEMINY	Without pacemaker	Vent Bigeminy	User-selectable
TRIGEMINY	Without pacemaker	Vent Trigeminy	User-selectable
R ON T	Without pacemaker	A type of single PVC under the condition that HR<100,R-R interval is less than 1/3 the average interval, followed by a compensating pause of 1.25X the average R-R interval(the next R wave advances onto the previous T wave).	User-selectable
PVC	Without pacemaker	Single PVCs not belonging to the type of above mentioned PVCs.	User-selectable
TACHY	All patients	5 consecutive QRS complex , RR interval is less than 500ms.	User-selectable
BRADY	All patients	5 consecutive QRS complex, RR interval is longer than 1.5s.	User-selectable
MISSED BEATS	Without pacemaker	When HR is less than 100 beats/min., no heart beat is tested during the period 1.75 times of the average RR interval; or When HR is larger than 100 beats/min., no beat is tested with 1 second.	User-selectable
PNP	With pacemaker	No QRS complex and pacing pulse are available during the period 1.75 times of the average R-R interval (only considering patients with pacemaker.)	User-selectable
PNC	With pacemaker	When pacing pulse is available, no QRS exists during the period 1.75 times of the average RR interval (only considering patients with pacemaker.)	User-selectable

Patient type:

All patients: refers to perform Arr.analysis on patients either with pacemakers or without pacemakers.

Without pacemaker: refers to perform Arr. Analysis only on the patients without pacemakers.

With pacemaker: refers to perform Arr. Analysis only on the patients with pacemakers.

Prompt message:

Message	Cause	Alarm Level
ARR LEARNING	The QRS template building required for Arr. Analysis is in process.	No alarm

Note

- **Arrhythmia name displays in the Alarm Message Area.**

11.9 Measuring RESP

11.9.1 How to measure RESP?

The monitor measures respiration from the amount of thoracic impedance between two ECG electrodes. The change of impedance between the two electrodes, (due to the thoracic movement), produces a respiratory waveform on the screen.

11.9.2 Setting Up RESP measurement

For RESP monitoring, it is not necessary for additional electrodes, however, the placing of electrodes is important.

Some patients, due to their clinical condition, expand their chest laterally, causing a negative intrathoracic pressure. In these cases it is better to place the two RESP electrodes laterally in the right axillary and left lateral chest areas at the maximum point of breathing movement to optimize the respiratory waveform.

Note

- **The RESP monitoring is not recommended to be used on patients who are very active, as this can cause false alarms.**

Checklist for RESP Monitoring

1. Prepare the patient's skin prior to placing the electrodes.
2. Attach snap or clip to the electrodes and attach the electrodes to the patient as described below.
3. Switch on the monitor.

11.9.3 Installing electrode for RESP measurement

Placing the Electrodes for Respiratory Monitoring:

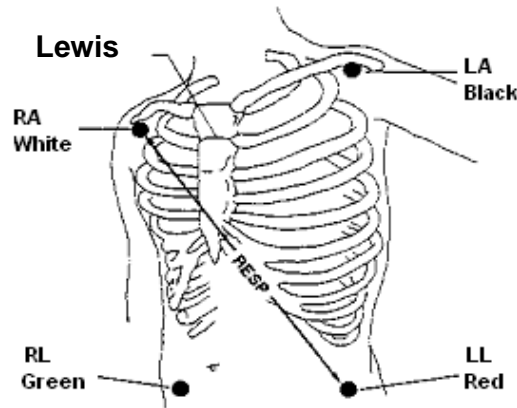

Figure 11-15 Electrodes Placement (5-lead)

Note

- **Place the red and green electrodes diagonally to optimize the respiration waveform. Avoid the liver area and the ventricles of the heart in the line between the RESP electrodes so as to avoid cardiac overlay or artifacts from pulsating blood flow. This is particularly important for neonates.**

11.9.4 RESP menu

RESP SETUP Menu

Pick RESP hot key on the screen to call up the following menu:

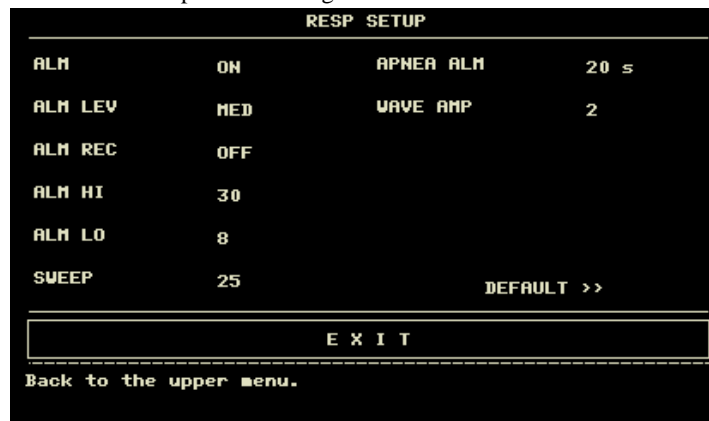



Figure 11-16 RESP Setup Menu

RESP alarm setting

- ALM: pick "ON" to enable prompt message and data record during the RESP alarm; pick "OFF" to disable the alarm function, and there will be a  beside "RESP".
- ALM REC: pick "ON" to enable report printing upon RESP alarm.
- ALM LEV: selectable from HI, MED and LO. Level HIGH represents the most serious case.

- ALM HI: used to set up the upper alarm limit.
- ALM LO: used to set up the lower alarm limit.

RESP alarm is activated when the respiration rate exceeds set ALM HI value or falls below ALM LO value.

RESP alarm limits:

	Max. RR HI	Min. RR LO	Step
RESP ADU	120	0	1
RESP NEO/PED	150	0	1

- APNEA ALM: to set the standard of judging an apnea case. It ranges from 10 to 40 seconds, increases / decreases by 5.
- SWEEP: Available options for RESP SWEEP are 6.25, 12.5 and 25.0 mm/s.
- WAVE AMP: The user may set up the displaying amplitude of the RESP waveform. The selections are $\times 0.25$, $\times 0.5$, $\times 1$, $\times 2$, $\times 4$.
- DEFAULT: pick this item to access the RESP DEFAULT CONFIG dialog box, in which the user may select whether the FACTORY DEFAULT CONFIG or the USER DEFAULT CONFIG is to be used. After selecting any of the items and exiting the dialog box, the system will pop up the dialog box asking for the user's confirmation

RESP Alarm Message

Among physiological alarms, those belonging to the type that the parameter has exceeded the limits may activate the recorder to automatically output the parameters and related measured waveforms when the alarms occur on the condition that the alarm record switch in the related menu is On.

Tables below describe the possible physiological alarms, technical alarms and prompt messages occurring during resp measurement.

Physiological alarms:

Message	Cause	Alarm Level
RR TOO HIGH	RESP measuring value is above upper alarm limit.	User-selectable
RR TOO LOW	RESP measuring value is below lower alarm limit.	User-selectable
RESP APNEA	RESP can not be measured within specific time interval.	HIGH

Technical alarms:

Message	Cause	Alarm Level	Remedy
RESP ALM LMT ERR	Functional safety failure	HIGH	Stop using RESP alarming function, notify biomedical engineer or Our service staff.

Prompt message (general alerts):

Message	Cause	Alarm Level
RR EXCEED	RR measuring value exceeds the measure range.	HIGH

11.10 Maintenance and Cleaning

11.10.1 Care and Cleaning

Warning

- **Before cleaning the monitor or the sensor, make sure that the equipment is switched off and disconnected from the power line.**

If there is any sign that the ECG cable may be damaged or deteriorated, replace it with a new one instead of continuing its application on the patient.

■ Cleaning:

Use fine-hair cloth moistened in mild soap liquid or cleaning agent containing 70% ethanol to clean the equipment.

■ Disinfection

To avoid long-term damage to the device, we suggest to disinfect the device only necessary during the maintenance plan. And we suggest to clean the device first before disinfection.

Advised disinfection material:

1. Ethanol group: 70% alcohol, 70% isopropanol
2. Aldehyde group

Chapter12 SpO₂ Monitoring

12.1 What is SpO₂ Monitoring

SpO₂ Plethysmogram measurement is employed to determine the oxygen saturation of hemoglobin in the arterial blood. If, for example, 97% hemoglobin molecules in the red blood cells of the arterial blood combine with oxygen, then the blood has a SpO₂ oxygen saturation of 97%. The SpO₂ numeric on the monitor will read 97%. The SpO₂ numeric shows the percentage of hemoglobin molecules which have combined with oxygen molecules to form oxyhemoglobin. The SpO₂/PLETH parameter can also provide a pulse rate signal and a plethysmogram wave.

How the SpO₂ / PLETH Parameter Works

- Arterial oxygen saturation is measured by a method called pulse oximeter. It is a continuous, non-invasive method based on the different absorption spectra of reduced hemoglobin and oxyhemoglobin. It measures how much light, sent from light sources on one side of the sensor, is transmitted through patient tissue (such as a finger or an ear), to a receiver on the other side.
- The sensor measurement wavelengths are nominally 660nm for the Red LED and 880nm for Infrared LED. Maximum optical power output for the Red LED is 6.65 mW and the Infrared LED is 6.75 mW.
- The amount of light transmitted depends on many factors, most of which are constant. However, one of these factors, the blood flow in the arteries, varies with time, because it is pulsating. By measuring the light absorption during a pulsation, it is possible to derive the oxygen saturation of the arterial blood. Detecting the pulsation gives a PLETH waveform and pulse rate signal.
- The SpO₂ value and the PLETH waveform can be displayed on the main screen.
- SpO₂ is a non-invasive measurement of the functional oxygen saturation.



Warning

- Pulse oximeter can overestimate the SpO₂ value in the presence of Hb-CO, Met-Hb or dye dilution chemicals.
 - ES (Electrosurgery) equipment wire and SpO₂ cable must not be tangled up.
 - Do not put the sensor on extremities with arterial catheter or venous syringe.
-

SpO₂ / Pulse Monitoring

Note

- Do not perform SpO₂ measuring and NIBP measuring on same arm at one time, because obstruction of blood flow during NIBP measuring may adversely affect the reading of SpO₂ value.
-

12.2 Precautions during SpO₂/Pulse Monitoring

Note

- Make sure the nail covers the light window;
 - The wire should be on the backside of the hand.
 - SpO₂ value is always displayed at the same position.
 - SpO₂ waveform is not proportional to the pulse volume.
 - Please read the measured value when the waveform on screen is equably and steady-going, This measured value is optimal value. And the waveform at the moment is the standard one.
-
- Pulse Rate will be displayed only under following situations:
 - ◆ Select HR FROM as "SpO₂" or "BOTH" in the ECG SETUP menu.
 - ◆ Select HR FROM as "AUTO" in the ECG SETUP menu and there is no ECG signal.
-



Warning

- Check if the sensor cable is in normal condition before monitoring. After unplugging the SpO₂ sensor cable from the socket, the system shall display the error message "SpO₂ SENSOR OFF" and give the audible alarm.
- When operating at the beginning, the operator inserts his finger, and setup the SpO₂ ALM HI lower than

the current measured value, then the machine will start alarm. The pulse rate alarm test is the same with the above.

- Do not use the SpO₂ sensor once the package or the sensor is found damaged. Instead, you shall return it to the vendor.
 - Prolonged and continuous monitoring may increase jeopardy of unexpected change of dermal condition such as abnormal sensitivity, rubescence, vesicle, repressive putrescence, and so on. It is especially important to check the sensor placement of neonate and patient of poor perfusion or immature dermogram by light collimation and proper attaching strictly according to changes of the skin. Check per 2~3 hours the sensor placement and move it when the skin deteriorates. More frequent examinations may be required for different patients.
-

12.3 Monitoring Procedure

SpO₂ plethysmogram measurement

1. Switch on the monitor.
2. Attach the sensor to the appropriate site of the patient finger.
3. Plug the connector of the sensor extension cable into the SpO₂ socket on the SpO₂ module.

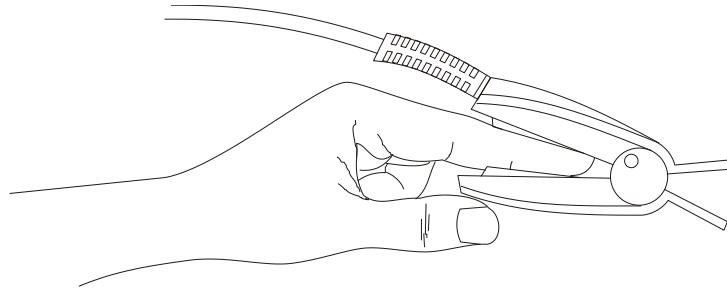

Figure 12-1 Mounting of the Sensor

■ Neonate SpO₂ Measurement

The process of measuring neonate SpO₂ is similar to that of measuring adult SpO₂. Below is the description of neonate SpO₂ sensor and its installation.

1. Neonate SpO₂ sensor

Neonate SpO₂ sensor consists of Y-form SpO₂ sensor and its sheath. Insert the LED and PD ends of the Y-form SpO₂ sensor respectively into the upper and lower grooves on the sheath (figure 12-2). Figure 12-3 shows us the neonate SpO₂ sensor after insertion.

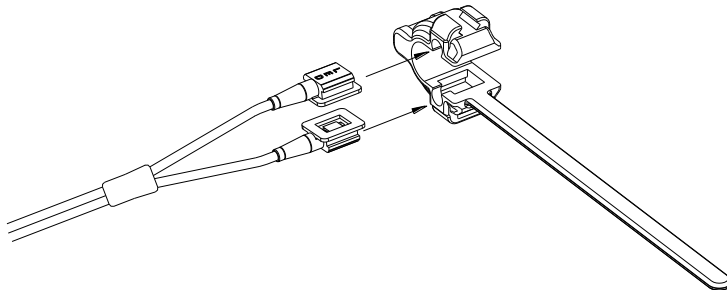

Figure 12-2 Neonate SpO₂ Sensor (1)

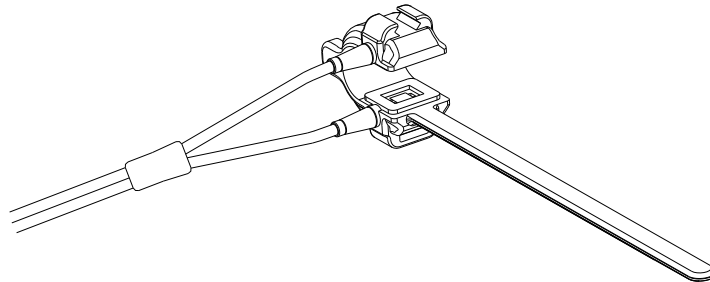

Figure 12-3 Neonate SpO₂ Sensor (2)

2. Attaching Neonate SpO₂ sensor

Wind the SpO₂ sensor around a hand or foot. Hold the sensor, pull the belt and fit one of its sides with “V” edge into the “V” groove on the corresponding side of the sheath. Appropriately elongate the belt (about 20mm) and fit the “V” edge of the other side of the belt into the “V” groove of the other side of the sheath and then loosen the belt. After the “V” edges of the two sides of the belt fit well into the “V” grooves on the two sides of the sheath, put the belt into the first lock bar to fasten the belt. See figure 12-4. If the belt is too much long, you may put it into the second lock bar. You must position the SpO₂ sensor in this way so as to make the photoelectric component face the correct position. In the mean time, note not to elongate the belt too much, which may lead to inaccurate measurement and also blocking the blood circulation severely.

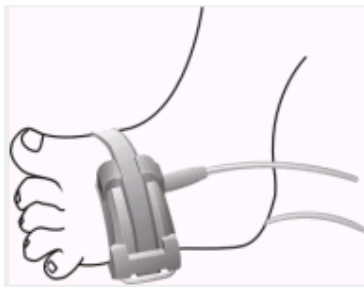

Figure 12-4

Note

-
- **If the sensor cannot be positioned accurately to the part to be measured, it may result in inaccurate SpO₂ reading, or even that the SpO₂ cannot be measured because no pulse is detected. If this is true, you must position the sensor again.**
 - **The excessive patient movement may result in inaccurate reading. In this situation, you must keep the patient quiet or change the part for monitoring to reduce the adverse influence of excessive movement.**
-

Warning

-
- **In the process of extended and continuous monitoring, you should check the peripheral circulation and the skin every 2 hours. If any unfavorable changes take place, you should change the measured position in time.**
 - **In the process of extended and continuous monitoring, you should periodically check the position of the sensor. In case that the position of the sensor moves during monitoring, the measurement accuracy may be affected.**
-

12.4 Limitations for Measurement

Measurement Limitations

In operation, the accuracy of oximeter readings can be affected by:

- High-frequency electrical noise, including noise created by the host system, or noise from external sources, such as electrosurgical apparatus connected to the system.
- Do not use oximeters and oximeter sensors during magnetic resonance imaging (MRI) scanning. Induced current could potentially cause burns.
- Intravascular dye injections
- Excessive patient movement
- External light radiation
- Improper sensor installation or incorrect contact position of the patient
- Sensor temperature (optimal temperature between 28°C and 42°C)
- Placement of the sensor on an extremity that has a blood pressure cuff, arterial catheter, or intravascular line.
- Significant concentrations of dysfunctional hemoglobin, such as carboxyhemoglobin and methemoglobin.
- SpO₂ too low
- Bad circular injection of the part being measured
- Shock, anemia, low temperature and application of vasomotor may all cause the arterial blood flow to reduce and hence make the measurement impossible.
- The absorption of oxyhemoglobin (HbO₂) and deoxyhemoglobin to the light of special wavelength may also affect SpO₂ measurement. If there exist other objects (carbon hemoglobin, methemoglobin, methylene blue and indigo carmine) absorbing the light of the same wavelength, they may result in false or low SpO₂ value.

- It is recommended to use SpO₂ sensors described in chapter Accessories and Ordering Information.

12.5 SpO₂ Menu

SpO₂ SETUP Menu

Turn the knob to move the cursor onto the SpO₂ hot key in the Parameter area, push the knob to access the SpO₂ SETUP menu.



Figure 12-5 SpO₂ SETUP menu

Warning

- **Setting the SpO₂ upper alarm limit to 100% is equivalent to switching off the alarm on upper limit. High oxygen levels may predispose a premature infant to retrolental fibroplasia. Therefore, the upper alarm limit for oxygen saturation must be carefully selected in accordance with commonly accepted clinical practices.**

SpO₂ alarm setting

- ALM: pick "ON", the system will give alarm prompt and store alarm information when SpO₂ alarm occurs; pick "OFF", the system will not give alarm and instead display a  beside "SpO₂".
- ALM REC: pick "ON", the system will command the recorder to output alarm information when SpO₂ alarm occurs.
- ALM LEV: used to set up alarm level, selectable from HI, MED and LO. HIGH represents the most serious case.
- SpO₂ ALM HI and SpO₂ ALM LO: SpO₂ alarm is activated when the result exceeds set SpO₂ ALM HI value or falls below SpO₂ ALM LO value.
- PR ALM HI and PR ALM LO: PR alarm is activated when the pulse rate exceeds set PR ALM HI value or falls below PR ALM LO value.

SpO₂ and PR alarm limits:

	Max. Upper Limit	Min. Lower Limit	Step
SpO ₂	100	0	1
PR	250	30	1

The default SpO₂ and PR alarm limits:

Parameters		Max. Upper Limit	Min. Lower Limit
SpO ₂	Adult	100	90
	Pediatric	100	90
	Neonatal	95	85
PR	Adult	120	50
	Pediatric	160	75

	Neonatal	200	100
--	----------	-----	-----

■ SWEEP

Available options are 12.5mm/s, 25.0 mm/s.

■ AVG TIME

4s, 8s, 16s represent times that SpO₂ average value is counted.

■ DEFAULT:

Pick this item to access the SpO₂ DEFAULT CONFIG dialog box, in which you can select FACTORY DEFAULT CONFIG or USER DEFAULT CONFIG. After selecting one item and exiting the dialog box, the system will pop up the dialog box asking for the your confirmation.

12.6 Alarm Description and Prompt

SpO₂ Alarm Message

When the alarm switches are set to ON in relevant menus, the physiological alarms caused by the parameter exceeding the alarm limit may possibly trigger the recorder to automatically output alarming parameter value and corresponding waveforms.

Tables below describe the possible physiological alarms, technical alarms and prompt messages occurring during SpO₂ measurement.

Physiological alarm:

Message	Cause	Alarm Level
SpO ₂ TOO HIGH	SpO ₂ measuring value is above upper alarm limit.	User-selectable
SpO ₂ TOO LOW	SpO ₂ measuring value is below lower alarm limit.	User-selectable
PR TOO HIGH	PR measuring value is above upper alarm limit.	User-selectable
PR TOO LOW	PR measuring value is below lower alarm limit.	User-selectable

Technical alarms:

Message	Cause	Alarm Level	Remedy
SpO ₂ SENSOR OFF	SpO ₂ sensor may be disconnected from the patient or the monitor.	LOW	Make sure that the monitor and the patient are in correct connection with the cables.
SpO ₂ INIT ERR	SpO ₂ module failure	HIGH	Stop using the measuring function of SpO ₂ module, notify biomedical engineer or our service staff.
SpO ₂ INIT ERR 1			
SpO ₂ INIT ERR 2			
SpO ₂ INIT ERR 3			
SpO ₂ INIT ERR 4			
SpO ₂ INIT ERR 5			
SpO ₂ INIT ERR 6			
SpO ₂ INIT ERR 7			
SpO ₂ INIT ERR 8			
SpO ₂ COMM STOP	SpO ₂ module failure or communication error	HIGH	Stop using the measuring function of SpO ₂ module, notify biomedical engineer or our service staff.
SpO ₂ COMM ERR	SpO ₂ module failure or communication error	HIGH	Stop using the measuring function of SpO ₂ module, notify biomedical engineer or our service staff.
SpO ₂ ALM LMT ERR	Functional safety failure	HIGH	Stop using the measuring function of SpO ₂ module, notify biomedical engineer or our service staff.
PR ALM LMT ERR	Functional safety failure	HIGH	Stop using the measuring function of SpO ₂ module, notify biomedical engineer or our service staff.

Prompt message (include general alerts):

Message	Cause	Alarm Level
SpO ₂ EXCEED	SpO ₂ measuring value exceeds the range.	HIGH
PR EXCEED	PR measuring value exceeds the range.	HIGH
SEARCH PULSE	SpO ₂ module is searching for pulse.	No alarm

NO PULSE	SpO ₂ module cannot detect SpO ₂ signal for a long time.	HIGH
----------	--	------

12.7 Maintenance and Cleaning

Care and Cleaning



Warning

- Turn off the monitor and disconnect the line power before cleaning the monitor or the sensor
 - Do not subject the sensor to autoclaving.
 - Do not immerse the sensor into any liquid.
 - Do not use any sensor or cable that may be damaged or deteriorated.
-

Cleaning:

- Use a cotton ball or a soft mull moistened with hospital-grade ethanol to wipe the surface of the sensor, and then dry it with a cloth. This cleaning method can also be applied to the luminotron and receiving unit.
- The cable can be cleaned with 3% hydrogen dioxide, 7% isopropanol, or other active reagent. However, connector of the sensor shall not be subjected to such solution.

Chapter13 NIBP Monitoring

13.1 Introduction

- Reference to the European standard EN 1060-1: Specification for Non-invasive sphygmomanometers Part 1, General requirements.
- The Non-invasive Blood Pressure (NIBP) module measures the blood pressure using the oscillometric method.
- It is applicable for adult, pediatric, and neonatal usage.
- There are three modes of measurement available: manual, automatic and continuous. Each mode displays the diastolic, systolic and mean blood pressure.
- In the MANUAL mode, only one measurement is conducted for each time.
- In the AUTO mode, the measurement is cycled; you can set the interval time to 1/ 2/ 3/ 4/ 5/ 10/ 15/30/60/90/120/240/480/960 minutes.
- In the continuous mode, the monitor measures the blood pressure as many times as possible in five minutes.



Warning

- **You must not perform NIBP measurements on patients with sickle-cell disease or under any condition which the skin is damaged or expected to be damaged.**
 - **For a thrombasthenia patient, it is important to determine whether measurement of the blood pressure shall be done automatically. The determination should be based on the clinical evaluation.**
 - **Ensure that the correct setting is selected when performing measurements on children. It may be dangerous for the children to use an over pressure level.**
-

13.2 NIBP Monitoring

13.2.1 NIBP Measuring



Warning

- **Before starting a measurement, verify that you have selected a setting appropriate for your patient (adult, pediatric or neonate.)**
 - **Do not apply the cuff to a limb that has an intravenous infusion or catheter in place. This could cause tissue damage around the catheter when infusion is slowed or blocked during cuff inflation.**
 - **Make sure that the air conduit connecting the blood pressure cuff and the monitor is neither blocked nor tangled.**
-

1. Plug in the air hose and switch on the system.
2. Apply the blood pressure cuff to the patient's arm or leg following the instructions below (Figure 13-1).
 - Ensure that the cuff is completely deflated.
 - Apply the appropriate size cuff to the patient, and make sure that the symbol "Φ" is over the appropriate artery. Ensure that the cuff is not wrapped too tightly around the limb. Excessive tightness may cause discoloration and eventual ischemia of the extremities.

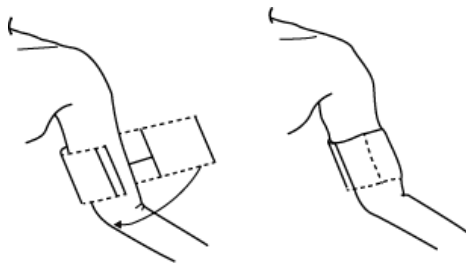

Figure 13-1 Applying Cuff

Note

- **The width of the cuff should be either 40% of the limb circumference (50% for neonates) or 2/3 of the upper arm length. The inflatable part of the cuff should be long enough to encircle 50-80% of the limb. The**

wrong size of cuff can cause erroneous readings. If the cuff size is in question, then use a larger cuff.

Size of reusable cuff for neonate/children/adult

Patient Type	Limb perimeter	Cuff width	Hose
Neonate	6~11cm	4.5cm	3 m
Infant	10 ~19 cm	8 cm	
Child	18 ~ 26 cm	10.6 cm	
Adult	25 ~ 35 cm	14 cm	
Large Adult	33 ~ 47 cm	17 cm	
Thigh	46 ~ 66 cm	21 cm	

- Make sure that the cuff edge falls within the range of mark <->. If it does not, use a larger or smaller cuff that fits better.
- 3. Connect the cuff to the air hose. The limb chosen for taking the measurement should be placed at the same level as the patient's heart. If this is not possible you should apply the following corrections to the measured values:
 - If the cuff is placed higher than the heart level, add 0.75 mmHg (0.10 kPa) for each inch of difference.
 - If it is placed lower than the heart level, deduct 0.75 mmHg (0.10 kPa) for each inch of difference.
- 4. Check whether the patient mode is appropriately selected. Access PATIENT SETUP menu from SYSTEM MENU and pick PAT TYPE item and turn the knob to select the required patient type.
- 5. Select a measurement mode in the NIBP SETUP menu. Refer to the following paragraphs Operation Hints for details
- 6. Press the START button on the front panel to start a measurement.

Operation Hints

1. To start auto measuring:

Access NIBP SETUP menu and pick the INTERVAL item, in which the user may choose the selections other than MANUAL to set up the time interval for auto measurement. After that, press START button on the front panel to start the auto measuring according to the selected time interval.

2. To stop auto measuring:

During auto measuring press START button on the front panel at any time to stop auto measurement.

3. To start a manual measuring:

- Access NIBP SETUP menu and pick the INTERVAL item. Select the MANUAL selection. Then press the START button on the front panel to start a manual measurement.

- During the idle period of auto measuring process, press the START button on the front panel at any time to start a manual measurement. Then press the START button on the front panel to stop manual measurement and the system continues executes auto-measuring program according to selected time interval.

4. To start a manual measuring during the AUTO mode

Press START button on the front panel.

5. To stop a manual measuring

Repress the START button on the front panel again.

6. To perform continuous measuring

Access NIBP SETUP menu and pick the CONTINUAL item to start the continuous measurement. The monitor will measure as many times of NIBP as possible within 5 minutes.

7. To stop continuous measuring

During continuous measuring press START button on the front panel at any time to stop continuous measurement.



Warning

- Prolonged non-invasive blood pressure measurements in Auto mode may be associated with purport, ischemia and neuropathy in the limb wearing the cuff. When monitoring a patient, examine the extremities of the limb frequently for normal color, warmth and sensitivity. If any abnormality is observed, stop the blood pressure measurements.
- Prolonged non-invasive blood pressure measurements in Continuous mode may be associated with purport, ischemia and neuropathy in the limb wearing the cuff. When monitoring a patient, examine the extremities of the limb frequently for normal color, warmth and sensitivity. If any abnormality is observed, stop the

blood pressure measurements.

- If liquid is inadvertently splashed on the equipment or its accessories, or may enter the conduit or inside the monitor, contact local Customer Service Center.

Note

-
- If you are in doubt about the accuracy of any reading(s), check the patient's vital signs by an alternative method before checking the functioning of the monitor.
-

Measurement Limitations

To different patient conditions, the oscillometric measurement has certain limitations. The measurement is in search of regular arterial pressure pulse. In those circumstances when the patient's condition makes it difficult to detect, the measurement becomes unreliable and measuring time increases. The user should be aware that the following conditions could interfere with the measurement, making the measurement unreliable or longer to derive. In some cases, the patient's condition will make a measurement impossible.

- **Patient Movement**

Measurements will be unreliable or may not be possible if the patient is moving, shivering or having convulsions. These motions may interfere with the detection of the arterial pressure pulses. In addition, the measurement time will be prolonged.

- **Cardiac Arrhythmia's**

Measurements will be unreliable and may not be possible if the patient's cardiac arrhythmia has caused an irregular heartbeat. The measuring time thus will be prolonged.

- **Heart-lung Machine**

Measurements will not be possible if the patient is connected to a heart-lung machine.

- **Pressure Changes**

Measurements will be unreliable and may not be possible if the patient's blood pressure is changing rapidly over the period of time during which the arterial pressure pulses are being analyzed to obtain the measurement.

- **Severe Shock**

If the patient is in severe shock or hypothermia, measurements will be unreliable since reduced blood flow to the peripheries will cause reduced pulsation of the arteries.

- **Heart Rate Extremes**

Measurements can not be made at a heart rate of less than 40 bpm and greater than 240 bpm.

13.2.2 NIBP monitoring screen

NIBP measurement result and corresponding message are displayed as follows:

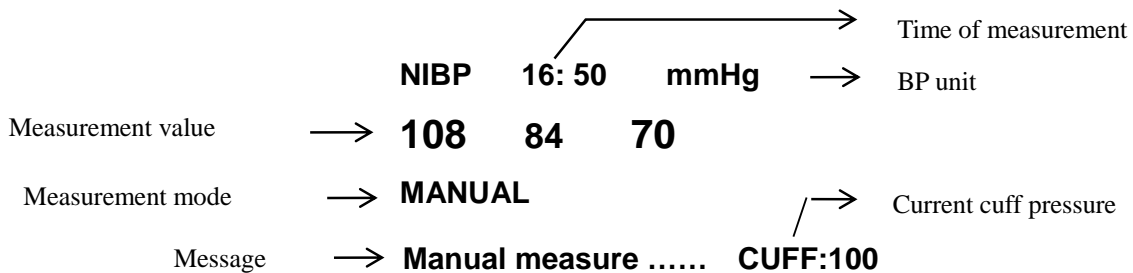

13.3 NIBP SETUP Menu

Pick the NIBP hot key on the screen to call up the NIBP menu shown as below:



Figure 13-2 NIBP SETUP Menu

NIBP alarm setting

- ALM: pick "ON" to enable prompt message and data record during the NIBP alarm; pick "OFF" to disable the alarm function, and there will be a  beside "NIBP".
- ALM LEV: selectable from HIGH, MED to LOW. HIGH represents the most serious case.
- ALM REC: pick "ON" to enable report printing upon NIBP alarm.
- SYS ALM HI, SYS ALM LOW, MEAN ALM HI, MEAN ALM LO, DIA ALM HI, DIA ALM LO are for the user to set up the alarm limit for each type of pressure. NIBP alarm is activated when the pressure exceeds set upper alarm limits or falls below lower alarm limits.

NIBP alarm limits

Adult Mode

SYS	40-270 mmHg
DIA	10-215 mmHg
Mean	20-235 mmHg

Pediatric Mode

SYS	40-200 mmHg
DIA	10-150 mmHg
Mean	20-165 mmHg

Neonatal Mode

SYS	40-135 mmHg
DIA	10-100 mmHg
Mean	20-110 mmHg

■ UNIT

Pick this item to set measurement unit. (Option: mmHg or kPa)

■ INTERVAL

Interval time for automatic measuring. Available selections: 1/2/3/4/5/10/15/30/60/90/120/240/480/960 minutes. Press START/STOP button on the NIBP module to start the first auto measuring.

Pick MANUAL selection in INTERVAL item to set up the measuring mode to MANUAL.

■ INFLATION

Can be set only for some customized module.

■ RESET

Restore measurement status.

Pick this item to restore initial settings of the pressure pump.

When the pressure does not work properly and the system fails to give message for the problem, pick this item to activate self-test procedure, thus restore the system from abnormal performance.

■ CONTINUAL

Start continuous measuring.

When this item is picked, the menu will disappear automatically.

■ CALIBRATE

Calibrate the cuff pressure reading with a calibrated reference manometer. Pick the CALIBRATE item to start the calibration and the item will change into STOP CAL, which if picked, the system will stop calibration.

Warning

- **The calibration of the NIBP measurement is necessary for every two years (or as frequently as dictated by your Hospital Procedures Policy). The performance should be checked according to the following details.**
-

Procedure of the Pressure Transducer Calibration:

Replace the cuff of the device with a rigid metal vessel with a capacity of 500 ml \pm 5%. Connect a calibrated reference manometer with an error less than 0.8 mmHg and a ball pump by means of a T-piece connector and hoses to the pneumatic system. Set the monitor in CALIBRATE mode. Inflate the pneumatic system to 0, 50 and 200 mmHg by ball pump separately. The difference between the indicated pressure of the reference manometer and the indicated pressure of the monitor will not exceed 3 mmHg. Otherwise, please contact our customer service.

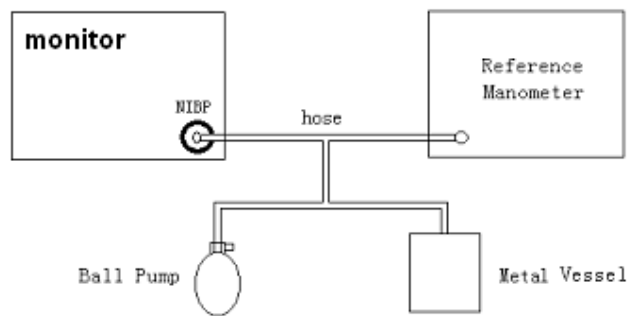

Figure Error. L'origine riferimento non è stata trovata.-3 Diagram of NIBP Calibration

■ PNEUMATIC

This item is used for air leakage test. Turn the knob to pick the item to start the air leakage test. Then the item will change into STOP PENUM, which if picked, the system will stop air leakage test.

Warning

- This pneumatic test other than being specified in the EN 1060-1 standard is to be used by the user to simply determine whether there are air leaks in the NIBP airway. If at the end of the test the system gives the prompt that the NIBP airway has air leaks, please contact the manufacturer for repair.
-

Procedure of the air leakage test:

- 1) Connect the cuff securely with the socket for NIBP air hole.
- 2) Wrap the cuff around the cylinder of an appropriate size.
- 3) Access the NIBP SETUP menu.
- 4) Turn the knob to the PNEUMATIC item and press the knob. Then the prompt "Pneum testing..." will appear on the bottom of the NIBP parameter area indicating that the system has started performing pneumatic test.
- 5) The system will automatically inflate the pneumatic system to about 180mmHg.
- 6) After 20 seconds or so, the system will automatically open the deflating valve, which marks the completion of a pneumatic measurement.
- 7) If no prompt appears on the bottom of the NIBP parameter area, it indicates that the airway is in good situation and no air leaks exist. However if the prompt "PNEUMATIC LEAK" appears in the place, it indicates that the airway may have air leaks. In this case, the user should check for loose connection. After confirming secure connections, the user should re-perform the pneumatic test. If the failure prompt still appears, please contact the manufacturer for repair.

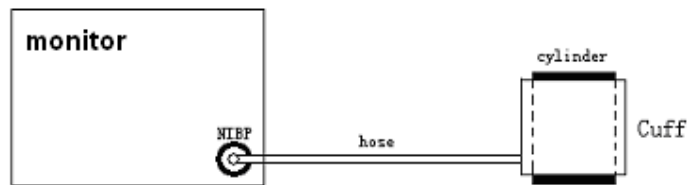

Figure 13-4 Diagram of NIBP Air Leakage Test

■ **DEFAULT**

Pick this item to access the NIBP DEFAULT CONFIG dialog box, in which the user may select whether the FACTORY DEFAULT CONFIG or the USER DEFAULT CONFIG is to be used. After selecting any of the items and exiting the dialog box, the system will pop up the dialog box asking for the user's confirmation.

13.4 NIBP Alarm Message

Among physiological alarms, those belonging to the type that the parameter has exceeded the limits may activate the recorder to automatically output the parameters and related measured waveforms when the alarms occur on the condition that the alarm record switch in the related menu is On.

Tables below describe the possible physiological alarms, technical alarms and prompt messages occurring during NIBP measurement.

Physiological alarms:

Message	Cause	Alarm Level
SYS TOO HIGH	NIBP SYS measuring value is above upper alarm limit.	User-selectable
SYS TOO LOW	NIBP SYS measuring value is below lower alarm limit.	User-selectable
DIA TOO HIGH	NIBP DIA measuring value is above upper alarm limit.	User-selectable
DIA TOO LOW	NIBP DIA measuring value is below lower alarm limit.	User-selectable
MEAN TOO HIGH	NIBP MAP measuring value is above upper alarm limit.	User-selectable
MEAN TOO LOW	NIBP MAP measuring value is below lower alarm limit.	User-selectable

Technical alarms 1: (display in information area)

Message	Cause	Alarm Level	Remedy
SYS ALM LMT ERR	Functional safety failure	HIGH	Stop using alarming functions of NIBP module and notify biomedical engineer or Our service staff.
MEAN ALM LMT ERR	Functional safety failure	HIGH	Stop using alarming functions of NIBP module and notify biomedical engineer or Our service staff.
DIA ALM LMT ERR	Functional safety failure	HIGH	Stop using alarming functions of NIBP module and notify biomedical engineer or Our service staff.

Technical alarms 2: (display in the area below the NIBP value)

Message	Cause	Alarm Level	Remedy
NIBP SELF TEST ERR	Sensor or other hardware of NIBP module is incorrect.	HIGH	Stop using measuring function of NIBP module, notify biomedical engineer or Our service staff.
NIBP COMM ERR	Communication with NIBP module is failed.	HIGH	If failure persists, stop using measuring function of NIBP module, notify biomedical engineer or Our service staff.
LOOSE CUFF	Cuff is no properly wrapped or no cuff exists.	LOW	Properly wrap the cuff
AIR LEAK	Cuff, hose or connector is damaged.	LOW	Check and replace the leaking parts, if required, notify biomedical engineer or Our service staff.
AIR PRESSURE ERROR	Stable pressure value is not available. e.g. hoses are tangled.	LOW	Check if the hoses are tangled, if failure persists, notify biomedical engineer or Our service staff.
WEAK SIGNAL	Cuff is too loose or patient pulse is too weak.	LOW	Use other method to measure blood pressure.

RANGE EXCEEDED	Measuring range exceeds the specified upper limit.	HIGH	Reset NIBP module, if failure persists, stop using measuring function of NIBP module, notify biomedical engineer or Our service staff.
EXCESSIVE MOTION	Affected by arm motion, signal noise is too large or pulse rate is not regular.	LOW	Make sure that the patient under monitoring is motionless.
OVER PRESSURE	Pressure has exceeded the specified upper safety limit.	HIGH	Measure again, if failure persists, stop using measuring function of NIBP module and notify biomedical engineer or Our service staff.
SIGNAL STURATED	Excessive motion	LOW	Stop the patient from moving.
PNEUMATIC LEAK	During pneumatic test, leak is detected.	LOW	Check and replace the leaking parts, if required, notify biomedical engineer or Our service staff.
NIBP SYSTEM FAILURE	Operation of blood pressure pump system is failed.	HIGH	Stop using measuring function of NIBP module, notify biomedical engineer or Our service staff.
CUFF TYPE ERR	Cuff type does not comply with the patient type.	LOW	Select appropriate cuff type
NIBP TIME OUT	Measuring time has exceeded 120 seconds (adult) or 90 seconds (neonatal).	HIGH	Measure again or use other measuring method.
NIBP ILLEGALLY RESET	Abnormal module reset	HIGH	Reset again
MEASURE FAIL	Problem happens when measuring the curve. The system cannot perform measurement, analysis or calculation.	HIGH	Check the cuff. Make sure that the patient under monitoring is motionless. Measure again.

Prompt message: (display in the prompt area below NIBP value)

Message	Cause	Alarm Level
Manual measure...	During manual measuring mode.	No alarm
Cont measuring...	During continuous measuring mode.	
Auto measuring...	During automatic measuring mode.	
Please start	After selecting interval between measurements in MENU	
Measurement over	Press START/STOP key during measuring to stop measurement	
Calibrating...	During calibrating	
Calibration over	Calibration over	
Pneum testing...	During pneumatic test	
Pneum test over	pneumatic test over	
Resetting...	NIBP module in resetting	
Reset failed	NIBP module reset failed	

13.5 Maintenance and Cleaning



Warning

- Do not squeeze the rubber tube on the cuff.
- Do not allow liquid to enter the connector socket at the front of the monitor.
- Do not wipe the inner part of the connector socket when cleaning the monitor.

- **When the reusable cuff is not connected with the monitor, or being cleaned, always place the cover on the rubber tube to avoid liquid permeation.**
-

Reusable Blood Pressure Cuff

The cuff can be sterilized by means of conventional autoclaving, gas, or radiation sterilization in hot air ovens or disinfected by immersion in decontamination solutions, but remember to remove the rubber bag if you use this method. The cuff should not be dry-cleaned.

The cuff can also be machine-washed or hand-washed, the latter method may prolong the service life of the cuff. Before washing, remove the latex rubber bag, and for machine-washing, close the Velcro fastening. Allow the cuff to dry thoroughly after washing, then reinsert the rubber bag.

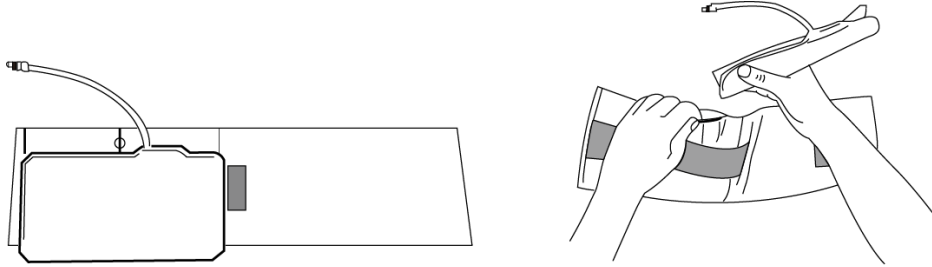

Figure 13-5 Replace Rubber Bag in Cuff

To replace the rubber bag in the cuff, first place the bag on top of the cuff so that the rubber tubes line up with the large opening on the long side of the cuff. Now roll the bag lengthwise and insert it into the opening on the long side of the cuff. Hold the tubes and the cuff and shake the complete cuff until the bag is in position. Thread the rubber tubes from inside the cuff, and out through the small hole under the internal flap.

Disposable Blood Pressure Cuffs

Disposable cuffs are intended for one-patient use only. Do not use the same cuff on any other patient. Do not sterilize or use autoclave on disposable cuffs. Disposable cuffs can be cleaned using soap solution to prevent infection.

Note

- **For protecting environment, the disposable blood pressure cuffs must be recycled or disposed of properly.**
-

Chapter14 TEMP Monitoring

14.1 TEMP Monitoring

Two TEMP probes can be used together to obtain 2 temperature data and compare them to work out the temperature difference.

TEMP monitoring setup

- If you are using disposable TEMP probes you need to plug the TEMP cable into the monitor and then connect the probe to the cable. With a reusable TEMP probe you can plug the probe directly into the monitor.
- Apply the TEMP probe(s) securely to the patient.
- Switch on the system.



Warning

- Verify probe cables fault detection before beginning of monitoring phase. Unplug the temperature probe cable of the channel 1 from the socket, the screen will display the error message “TEMP SENSOR1 OFF” and the audible alarm is activated. The other channel is the same.

The calibration of the temperature measurement is necessary for every two years (or as frequently as dictated by your Hospital Procedures Policy). When you need calibrate the temperature measurement, contact the manufacture please.

Note

- Disposable TEMP probe can only be used once for one patient.
 - The self-test of the temperature measurement is performed automatically once per hour during the monitoring. The test procedure lasts about 2 seconds and does not affect the normal measurement of the temperature monitoring.
-

14.2 TEMP SETUP Menu

Pick the TEMP hot key on the screen to call up the TEMP SETUP menu shown as below:

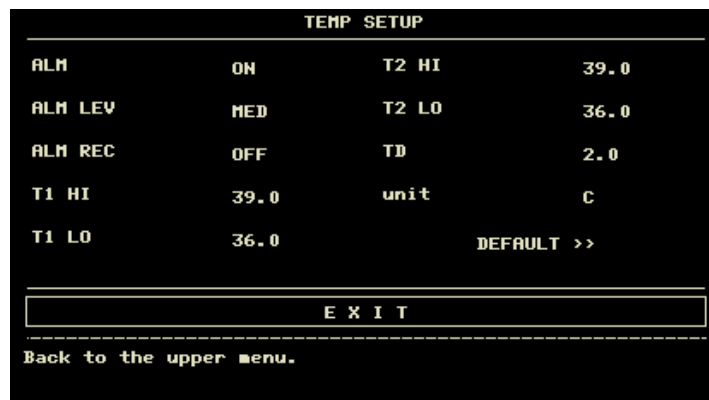



Figure 14-1 TEMP Setup Menu

TEMP alarm setting

- ALM: pick "ON" to enable prompt message and data record during the TEMP alarm; pick "OFF" to disable the alarm function, and prompt the  symbol beside TEMP numeric.
- ALM LEV: used to set up the alarm level, selectable from HIGH, MED or LOW.
- ALM REC: used to start/stop recording TEMP alarms. Pick "ON" to enable report printing upon TEMP alarm.
- Alarm for T1, T2 and TD occurs when the measured temperature exceeds set alarm high limit or falls below alarm low limit.

T1 is Channel-1 temperature, T2 is Channel-2 temperature, TD is the temperature difference between the above two.

TEMP alarm limits:

	Max. TEMP HI	Min. TEMP LO	Step
T1, T2	50	0	0.1
TD	50	0	0.1

- UNIT To set temperature unit (°C or °F).
- DEFAULT Pick this item to access the TEMP DEFAULT CONFIG dialog box, in which the user may select whether the FACTORY DEFAULT CONFIG or the USER DEFAULT CONFIG is to be used. After selecting any of the items and exiting the dialog box, the system will pop up the dialog box asking for the user's confirmation.

14.3 TEMP Alarm message

Among physiological alarms, those belonging to the type that the parameter has exceeded the limits may activate the recorder to automatically output the parameters and related measured waveforms when the alarms occur on the condition that the alarm record switch in the related menu is On.

Tables below describe the possible physiological alarms, technical alarms and prompt messages occurring during TEMP measurement.

Physiological alarms:

Message	Cause	Alarm Level
T1 TOO HIGH	Measuring value of channel 1 is above upper alarm limit.	User-selectable
T1 TOO LOW	Measuring value of channel 1 is below lower alarm limit.	User-selectable
T2 TOO HIGH	Measuring value of channel 2 is above upper alarm limit.	User-selectable
T2 TOO LOW	Measuring value of channel 2 is below lower alarm limit.	User-selectable
TD TOO HIGH	Difference between two channels is larger than upper limit.	User-selectable

Technical alarms:

Alarm Message	Cause	Alarm Level	Remedy
T1 SENSOR OFF	Temperature cable of channel 1 may be disconnected from the monitor.	LOW	Make sure that the cable is properly connected.
T2 SENSOR OFF	Temperature cable of channel 2 may be disconnected from the monitor.	LOW	Make sure that the cable is properly connected.
T1 ALM LMT ERR	Functional safety failure	HIGH	Stop using alarming function of TEMP module, notify biomedical engineer or Our service staff.
T2 ALM LMT ERR	Functional safety failure	HIGH	Stop using alarming function of TEMP module, notify biomedical engineer or Our service staff.
TD ALM LMT ERR	Functional safety failure	HIGH	Stop using alarming function of TEMP module, notify biomedical engineer or Our service staff.

Prompt message:

Message	Cause	Alarm Level
T1 EXCEED	Measuring value of channel 1 is beyond measuring range.	HIGH
T2 EXCEED	Measuring value of channel 2 is beyond measuring range.	HIGH

14.4 Care and Cleaning

Warning

- Before cleaning the monitor or the probe, make sure that the equipment is switched off and disconnected from the power line.

Reusable TEMP Probes

- 1 The TEMP probe should not be heated above 100°C (212°F). It should only be subjected briefly to temperatures between 80°C (176°F) and 100°C (212°F).
- 2 The probe must not be sterilized in steam.
- 3 Only detergents containing no alcohol can be used for disaffection.
- 4 The rectal probes should be used, if possible, in conjunction with a protective rubber cover.
- 5 To clean the probe, hold the tip with one hand and with the other hand rubbing the probe down in the direction of the connector using a moist lint-free cloth.

Note

-
- **Disposable TEMP probe must not be re-sterilized or reused.**
 - **For protecting environment, the disposable TEMP probe must be recycled or disposed of properly.**
-

Chapter15 IBP Monitoring(optional)

15.1 Introduction

The Monitor measures direct blood pressure (SYS, DIA and MAP) of one selected blood vessel through two channels, and displays two BP waveforms measures direct blood pressure (SYS, DIA and MAP).

The available pressure labels are:

Label	Definition
ART	Arterial Blood Pressure
PA	Pulmonary Arterial Pressure
CVP	Center Venous Pressure
RAP	Right Atrial Pressure
LAP	Left Atrial Pressure
ICP	Intracranium Pressure
P1-P2	Expand Pressure

15.2 Precautions during IBP Monitoring



Warning

- The operator should avoid contact with the conductive parts of the appurtenance when being connected or applied.
 - When the monitor is used with HF surgical equipment, the transducer and the cables must be avoided conductive connection to the HF equipment to protect against burns to the patient.
 - Disposable IBP transducer or domes should not be reused.
 - Verify transducer cables fault detection before beginning of monitoring phase. Unplug the transducer of the channel 1 from the socket, the screen will display the error message “IBP: SENSOR 1 OFF” and the audible alarm is activated. The other channel is the same.
 - If any kind of liquid, other than solution to be infused in pressure line or transducer, is splashed on the equipment or its accessories, or may enter the transducer or the monitor, contact the Hospital Service Center immediately.
-

Note

- Use only the pressure transducer listed in the Chapter Accessories and Ordering Information.
 - The specified transducer is designed to have the special ability to protect against the electricity shock (especially for the leak current allowed), and it is protected against the effects of a discharge of a cardiac defibrillator. It can be used in the surgical operation. When the patient is in the defibrillation, the waveform of the pressure maybe distorted temporarily. After the defibrillation, the monitoring will go on normally, the operation mode and the user configuration are not affected.
 - Calibrate the instrument either whenever a new transducer is used, or as frequently as dictated by your Hospital Procedures Policy.
-

15.3 Monitoring Procedure

Preparatory steps for IBP measurement:

1. Plug the pressure cable into corresponding socket and check that the monitor is switched on.
 2. Prepare the pressure line and transducer by flushing through the system with normal saline solution. Ensure that the system is free of air bubbles.
 3. Connect the patient catheter to the pressure line, making sure that there is no air present in the catheter or pressure line.
-



Warning

- If there are air bubbles in the pressure line or the transducer, you should flush the system with the solution

to be infused.

4. Position the transducer so that it is at the same level with the patient's heart, approximately mid-axillary line.
5. Check if you have selected the correct label name. See the next section for details.
6. Zero the transducer. See the next section for details.

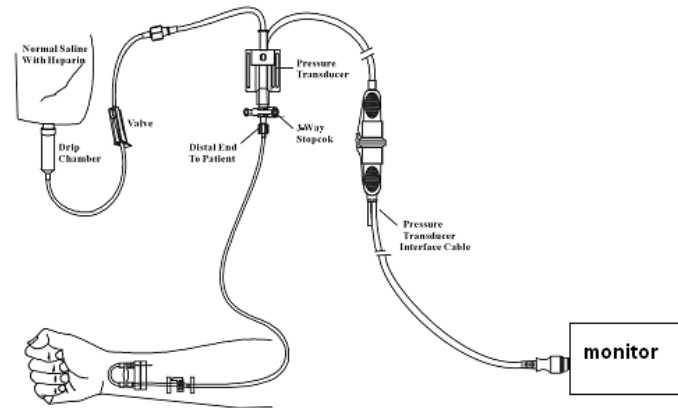

Figure Errore. L'origine riferimento non è stata trovata.-4 IBP Monitoring

15.4 IBP Menu

Pick the IBP hot key on the screen to access the IBP SELECT menu shown as following:



Figure Errore. L'origine riferimento non è stata trovata.-5 IBP SELECT Menu

Pick the IBP SETUP item to call up the IBP SETUP menu as following:

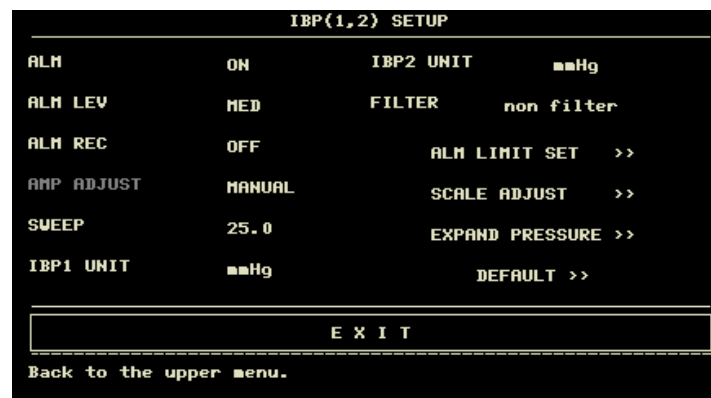



Figure Errore. L'origine riferimento non è stata trovata.-6 IBP SETUP Menu

The items to be set up in the menu include:

- ALM: Select "ON" to enable alarm prompt and data storage during IBP alarm. Select "OFF" to disable audio alarm and prompt the  symbol beside "IBP" numeric.
- ALM LEV: used to set up the alarm level. Three levels are available: HI, MED, LO.

- ALM REC: Select “ON” to enable recording during the IBP alarm or to OFF to disable the alarm recording function.
- SWEEP: used to select the scanning speed of the IBP wave. Two selections are available: 12.5 mm/s or 25 mm/s.
- IBP1 UNIT/IBP2 UNIT: used to select the pressure unit (mmHg / kPa / cmH2O).
- FILTER: non filter, smooth, normal.
- ALM LIMIT SET: used to access the sub-menu of IBP ALM LIMIT SET, in which the user may set up the upper and lower alarm limit of systolic pressure, diastolic pressure and mean pressure respectively for channel 1 and channel 2.
- SCALE ADJUST: used to access the sub-menu of IBP PRESS RULER ADJUST, in which the user may adjust the position of the high, reference and low scales for the two waveforms displayed on the screen.
- EXPAND PRESSURE: used to access the sub-menu of IBP EXPAND PRESS SET, in which the user may select the pressure name to be represented by P1, P2.
- DEFAULT: pick this item to access the IBP DEFAULT CONFIG dialog box, in which the user may select whether the FACTORY DEFAULT CONFIG or the USER DEFAULT CONFIG is to be used. After selecting any of the items and exiting the dialog box, the system will pop up the dialog box asking for the user’s confirmation.
- EXIT: used to exit the menu and return to the main screen.

 **Warning**

- Before set the alarm limits, confirm to choose the correct label.

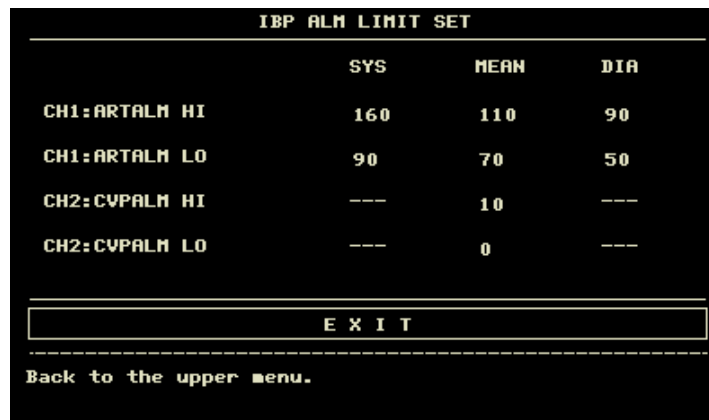

Figure Errore. L'origine riferimento non è stata trovata.-7 **IBP ALM LIMIT SETUP**

The alarm occurs when the value exceeds the set limits.

IBP alarm limits:

Pressure Label	Max. Alarm High (mmHg)	Min. Alarm Low (mmHg)	Step (mmHg)
ART	300	-10	1
PA	300	-10	1
CVP	300	-10	1
RAP	300	-10	1
LAP	300	-10	1
ICP	300	-10	1
P1	300	-10	1
P2	300	-10	1

IBP Transducer Zero

Press the IBP PRESSURE ZERO button on the IBP SELECT menu to call up IBP PRESSURE ZERO menu as shown below:



Figure Errore. L'origine riferimento non è stata trovata.-8 IBP PRESSURE ZERO

Note

- It is the responsibility of the user to ensure that a zero procedure has recently been done on the transducer, otherwise there will be no recent, valid zero value for the instrument to use, which may result in inaccurate measurement results.

Zero Calibration of Transducer

Select CH1, the system will zero IBP1. Select CH2, the system will zero IBP2.



Caution

- Turn off patient stopcock before you start the zero procedure.
- The transducer must be vented to atmospheric pressure before the zero procedure.
- The transducer should be placed at the same height level with the heart, approximately mid-axially line.
- Zero procedure should be performed before starting the monitoring and at least once a day after each disconnect-and-connect of the cable.

The prompt information related to zero, take CH1 for example.

- “SENSOR OFF, FAIL”

Make sure that transducer is not off, then proceed zeroing.

- “IN DEMO FAIL”

Make sure that the monitor is not in DEMO mode. Contact service technician if necessary.

- “PRESSURE OVER RANGE, FAIL”

Make sure that the stopcock is vented to atmosphere. If the problem persists, contact service technician.

- “PULSATILE PRESSURE, FAIL”

Make sure that the transducer is not attached to the patient and that the stopcock is vented to atmosphere. If the problem persists, contact service technician.

IBP Calibration

Press the IBP PRESSURE CALIBRATION button on the IBP SELECT menu to call up the IBP PRESSURE CALIBRATE menu as shown below:

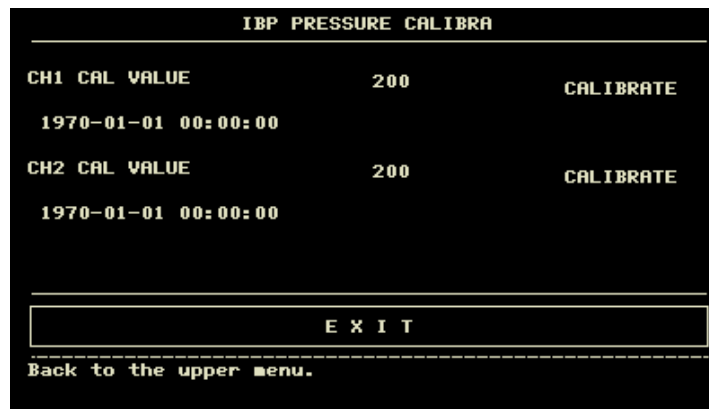

Figure Errore. L'origine riferimento non è stata trovata.-9 IBP Calibration Menu

Calibrate the transducer:

Turn the knob to select the item CH1 CAL VALUE, press and turn the knob to select the pressure value to be calibrated for channel 1. Then turn the knob to select the item CALIBRATE to start calibrating channel 1.

Turn the knob to select the item CH2 CAL VALUE, press and turn the knob to select the pressure value to be calibrated for channel 2. Then turn the knob to select the item CALIBRATE to start calibrating channel 2.

- The pressure calibration of the monitor

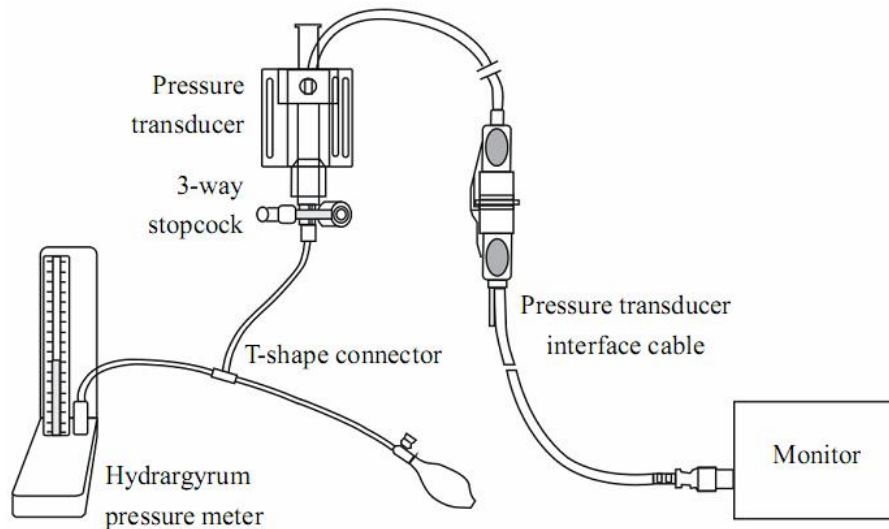

Figure Errore. L'origine riferimento non è stata trovata.-10 IBP Calibration

⚠ Caution

- Mercury calibration should be performed by the biomedical engineering department either whenever a new transducer is used, or as frequently as dictated by your Hospital Procedures Policy.
- The purpose of the calibration is to ensure that the system gives you accurate measurements.
- Before starting a mercury calibration, a zero procedure must be performed.
- If you need to perform this procedure yourself you will need the following pieces of equipment:
 1. Standard sphygmomanometer
 2. 3-way stopcock
 3. Tubing approximately 25 cm long
- The Calibration Procedure: (SEE Figure Errore. L'origine riferimento non è stata trovata.-10)

⚠ Warning

- You must never perform this procedure while patient is being monitored.

1. Close the stopcock that was open to atmospheric pressure for the zero calibration.
2. Attach the tubing to the sphygmomanometer.
3. Ensure that connection that would lead to patient is off.
4. Connect the 3-way connector to the 3-way stopcock that is not connected to the patient catheter.
5. Open the port of the 3-way stopcock to the sphygmomanometer.
6. Select the channel to be calibrated in the menu and select the pressure value to which the IBP is to be adjusted.
7. Inflate to make the mercury bar rise to the setup pressure value.
8. Adjust repeatedly until the value in the menu is equal to the pressure value shown by the mercury calibration.
9. Press the Start button, the device will begin calibrating.
10. Wait for the calibrated result. You should take corresponding measures based on the prompt information.
11. After calibration, disassemble the blood pressure tubing and the attached 3-way valve.

If the following messages prompt up, refer to relevant instructions (take channel-1 for instance):

- “SENSOR OFF, FALL”

Make sure that sensor is not off, then proceed calibration.

- “IN DEMO, FAIL”

Make sure that the monitor is not in DEMO mode. Contact service technician if necessary.

- “PRESSURE OVER RANGE, FAIL”

Make sure that you have selected transducer value in IBP CAL, then proceed calibration.

Changing the Label

- IBP SCALE ADJUST submenu:

IBP PRESS RULER ADJUST			
	HI	LO	VAL
CH1:ART	160	0	82
CH2:CVP	40	0	20
E X I T			
Back to the upper menu.			

Figure Errore. L'origine riferimento non è stata trovata.-11 IBP SCALE ADJUST Menu

The waveform and corresponding scale appears in the IBP Waveform Area with 3 dotted lines representing High Limit Scale, Reference Scale, and Low Limit Scale from the top to the bottom. Values of the three scales can be user-set according to the instruction given below.

- IBP label: selectable from ART, PA, CVP, RAP, LAP, ICP, P1, P2;
- HI: IBP value of High Limit scale, the range is the measuring range of the current pressure.

Note

- **The HI value must be higher than the LO value.**
LO: IBP value of Low Limit scale, the range is the measuring range of the current pressure.
- **The LO value must be lower than the HI value.**
VAL: IBP value of Reference scale (between HI and LO).
- **When change HI scale, Low scale or Reference scale of IBP waveform and the corresponding IBP waveforms are displayed under the menu window, the waveform will come penetratingly through the menu window for observing.**

15.5 Alarm Information and Prompts

Alarm Messages

Among physiological alarms, those belonging to the type that the parameter has exceeded the limits may activate the recorder to automatically output the parameters and related measured waveforms when the alarms occur on the condition that the alarm record switch in the related menu is On.

Tables below describe the possible physiological alarms, technical alarms and prompt messages occurring during IBP measurement.

Physiological alarms:

Message	Cause	Alarm Level
IS1 TOO HIGH	SYS measuring value of channel 1 is above upper alarm limit.	User-selectable
IS1 TOO LOW	SYS measuring value of channel 1 is below lower alarm limit.	User-selectable
ID1 TOO HIGH	DIA measuring value of channel 1 is above upper alarm limit.	User-selectable
ID1 TOO LOW	DIA measuring value of channel 1 is below lower alarm limit.	User-selectable
IM1 TOO HIGH	MAP measuring value of channel 1 is above upper alarm limit.	User-selectable
IM1 TOO LOW	MAP measuring value of channel 1 is below lower alarm limit.	User-selectable
IS2 TOO HIGH	SYS measuring value of channel 2 is above upper alarm limit.	User-selectable
IS2 TOO LOW	SYS measuring value of channel 2 is below lower alarm limit.	User-selectable
ID2 TOO HIGH	DIA measuring value of channel 2 is above upper alarm limit.	User-selectable
ID2 TOO LOW	DIA measuring value of channel 2 is below lower alarm limit.	User-selectable
IM2 TOO HIGH	MAP measuring value of channel 2 is above upper alarm limit.	User-selectable
IM2 TOO LOW	MAP measuring value of channel 2 is below lower alarm limit.	User-selectable

Technical alarms:

Message	Cause	Alarm Level	Remedy
IBP1 SENSOR OFF	IBP cable of channel 1 fails off from monitor.	LOW	Make sure that cable is properly connected.
IBP2 SENSOR OFF	IBP cable of channel 2 fails off from monitor.	LOW	Make sure that cable is properly connected.
IBP(1,2) INIT ERR	IBP module failure	HIGH	Stop using measuring function of IBP module, notify biomedical engineer or Our service staff.
IBP(1,2) INIT ERR1			
IBP(1,2) INIT ERR2			
IBP(1,2) INIT ERR3			
IBP(1,2) INIT ERR4			
IBP(1,2) INIT ERR5			
IBP(1,2) INIT ERR6			
IBP(1,2) INIT ERR7			
IBP(1,2) INIT ERR8			
IBP(1,2) COMM STOP	IBP(1,2) module failure or communication failure	HIGH	Stop using measuring function of IBP module, notify biomedical engineer or Our service staff.
IBP(1,2) COMM ERR	IBP(1,2) communication error	HIGH	Stop using measuring function of IBP module, notify biomedical engineer or Our service staff.
IBP1 ALM LMT ERR	Functional safety failure	HIGH	Stop using measuring function of IBP module, notify biomedical engineer or Our service staff.
IBP2 ALM LMT ERR	Functional safety failure	HIGH	Stop using measuring function of IBP module, notify biomedical engineer or Our service staff.

Prompt message (general alerts):

Message	Cause	Alarm Level
---------	-------	-------------

IBP1 SYS EXCEED	Systolic measuring value of channel 1 is beyond measurement range.	HIGH
IBP1 DIA EXCEED	Diastolic measuring value of channel 1 is beyond measurement range.	HIGH
IBP1 MEAN EXCEED	Mean measuring value of channel 1 is beyond measurement range.	HIGH
IBP2 SYS EXCEED	Systolic measuring value of channel 2 is beyond measurement range.	HIGH
IBP2 DIA EXCEED	Diastolic measuring value of channel 2 is beyond measurement range.	HIGH
IBP2 MEAN EXCEED	Mean measuring value of channel 2 is beyond measurement range.	HIGH
IBP1 NEED ZERO-CAL	Zero calibrating must be done before measuring in IBP channel 1.	LOW
IBP2 NEED ZERO-CAL	Zero calibrating must be done before measuring in IBP channel2.	LOW

15.6 Maintenance and Cleaning

15.6.1 Care and Cleaning

Warning

- **Before cleaning the monitor or the transducer, make sure that the equipment is switched off and disconnected from the power line.**
-

Cleaning of IBP Transducer (Reusable)

After the IBP monitoring operation is completed, remove the tubing and the dome from the transducer and wipe the transducer diaphragm with water. Soaking and/or wiping with soap can clean the transducer and cable and water or cleaning agents such as those listed below:

- Cetylcide
- Wavicide-01
- Wescodyne
- Cidex
- Lysol
- Vesphene

Do not immerse the connector in any liquid. After cleaning, dry the transducer thoroughly before storing. Slight discoloration or temporary increase of surface stickiness of the cable should not be considered abnormal. If adhesive tape residue must be removed from the transducer cable, double seal tape remover is effective and will cause a minimum of damage to the cable if used sparingly. Acetone, Alcohol, Ammonia and Chloroform, or other strong solvents are not recommended because over time the vinyl cabling will be damaged by these agents.

Note

- **The disposable transducers or domes must not be re-sterilized or re-used.**
- **For protecting environment, the disposable transducers or domes must be recycled or disposed of properly.**

Sterilization

■ Liquid Chemical Sterilization

Remove obvious contamination by using the cleaning procedure described previously. Select a sterilant that your hospital or institution has found to be effective for liquid chemical sterilization of operating room equipment. Buffered glutaraldehyde (e.g. Cidex or Hospisept) has been found to be effective. Do not use quaternary cationic detergents such as zephiran chloride. If the whole unit is to be sterilized, immerse the transducer but not the electrical connector into the sterilant for the recommended sterilizing period. Be sure that the dome is removed. Then rinse all transducer parts except the electrical connector with sterilized water or saline. The transducer must be thoroughly dried before storing.

■ Gas Sterilization

For more complete asepsis, use gas sterilization.

Remove obvious contamination by using the cleaning procedure described previously. To inhibit the formation of ethylene glycol when ethylene oxide gas is used as the disinfectant, the transducer should be completely dry.

Follow the operating instructions provided by the manufacturer of the gas disinfectant.



Warning

- **The sterilize temperature must not exceed 70°C (158°F). Plastics in the pressure transducer may deform or melt above this temperature.**
-
-

Chapter16 CO₂ Measuring(optional)

16.1 General

This chapter offers some relevant data concerning CO₂ monitoring.

The monitor provides two kinds of CO₂ measuring methods as per the requirements of users, which are MainStream and SideStream.

The module is used to monitor continuous carbon dioxide and report the End Tidal carbon dioxide (ETCO₂), Inspired CO₂ (InsCO₂) and Air Way Respiratory Rate(AWRR) values of the intubated and non-intubated adult, pediatric, infant and neonatal patient.

CO₂: EtCO₂

INS: Inspired Minimum CO₂(InsCO₂).

AWRR: Air Way Respiration (AwRR)(Resp. times/MIN).

Note

- Before use, if the measurement is MainStream, you must set the "work mode" to "measure" in the submenu "OTHER SET" of "CO₂ SETUP", otherwise the module will not work correctly.
- Don't use the device in the environment with flammable anesthetic gas.
- The device can only be operated by personnel having taken professional training and familiar with this manual.



Warning

- CO₂ module shall be avoided from crash and vibration.
- Do not operate the CO₂ Module when it is wet or has exterior condensation.
- Do not connect the exhaust tube to the ventilator circuit.
- This product and its accessories are latex free.
- DO NOT use device on patients that can not tolerate the withdrawal of 50 ml/min +/- 10 ml/min from the airway or patients that can not tolerate the added dead space to the airway.

16.2 Monitoring Procedure

16.2.1 Principle of operation

The measurement of this module is based on the feature that the CO₂ molecule absorbs 4.3um infrared ray. The measurement procedure is as follows: send the CO₂ to a measurement chamber inside the module through the airway system, and then irradiate infrared ray at one side of the chamber and use the sensor to measure the attenuation degree of the received infrared ray at the other side. Since the attenuation degree of the infrared ray is proportional to the concentration of CO₂, the CO₂ concentration is calculated.

The relation between the partial pressure and the CO₂ concentration is given below:

CO₂ partial pressure (mmHg) = CO₂ concentration (%) × Pamp (ambient pressure, mmHg)

Of CO₂ MainStream and CO₂ SideStream modules, whichever is selected by the user, autorun measuring mode is adopted.

16.2.2 Operation for CO₂ Measurement

■ Sidestream



Figure 16-1 Sample Canula



Figure 16-2 SideStream Module

1. The Sidestream module can be used for intubated and non-intubated patient.
2. Insert LEMO interface to socket(CO₂) of the monitor
3. Connect the sample cell to the module,the sampling pump automatically turns on.Perform sample cell zero.
4. Place the sampling line on the patient. Removal the sample cell automatically turns sampling pump off.
5. Capnogram displayed in less than 20 seconds, at an ambient temperature of 25°C, full specifications within 2 minutes.

■ **Mainstream**



Figure 16-3 MainStream Module

1. The mainstream module can only be used for intubated patient.
2. Set the "WORK MODE" to "MEASUREMENT" in the submenu "OTHER SET" of "CO₂ MENU".
3. Connect the module to the monitor.
4. Place the module above on the adapter.
5. Perform airway adapter zero.
6. Connect the airway adapter into the patient's airway.
7. Capnogram, displayed in less than 15 seconds at an ambient temperature of 25°C, full specifications within 2 minutes.

⚠ Warning

- Do not use the accessory if the packaging or the internal accessory is damaged. Return it to the manufacturer.
 - The sidestream sampling line is disposable. It should not be disinfected for reuse or cross-used by different patients.
 - In the long-term use, dust or other substances may lower the air permeability of the filter material in the sample cell and may block the airway. In this situation, the sampling line must be replaced.
 - No routine user calibration required. For mainstream,an airway adapter zero is required when changing to a different style of airway adapter.
-

16.3 CO₂ Menu

16.3.1 Parameter Setup and Adjustment

Turn the knob to select and press CO₂ hot key on the screen to activate “CO₂ Setup” menu as shown below:

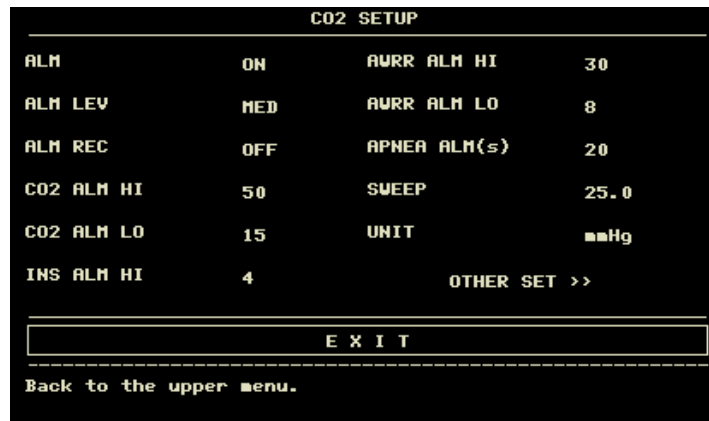



Figure Errore. L'origine riferimento non è stata trovata.-4 CO₂ Setup Menu

Following functions can be realized via CO₂ SETUP menu.

- ALM: select “ON” to enable and store alarm prompt when CO₂ parameters have alarms. Select “OFF” to disable alarm and display  beside CO₂. The default is “ON”.
- ALM LEV: select from HI, MED and LO. Level HIGH represents the most serious alarm, followed by Level MED and Level LOW with a decrease of seriousness. Change in “ALM LEV” can only affect the physiological alarm levels of CO₂ parameters including EtCO₂ upper limit, EtCO₂ lower limit, InsCO₂ upper limit, AwRR upper limit and AwRR lower limit. The default alarm level is “MED”.
- ALM REC: select “ON” to generate output from the recorder ever since CO₂ parameter alarm occurs. The default is “OFF”.
- CO₂ ALM HI: to adjust the upper alarm limit of EtCO₂. If the measuring value is larger than CO₂ upper alarm limit, “CO₂ TOO HIGH” appears on the screen. After the measuring value returns to the normal one, the information disappears.
- CO₂ ALM LO: to adjust the lower alarm limit of EtCO₂. If the measuring value is smaller than CO₂ lower alarm limit, “CO₂ TOO LOW” appears on the screen. After the measuring value returns to the normal one, the information disappears.
- INS ALM HI: to adjust the upper alarm limit of InsCO₂. If the measuring value is larger than InsCO₂ upper alarm limit, “INS TOO HIGH” appears on the screen. After the measuring value returns to the normal one, the information disappears.
- AWRR ALM HI: to adjust the upper alarm limit of AwRR. If the measuring value is larger than the upper alarm limit of AwRR, “AWRR TOO HIGH” appears on the screen. After the measuring value returns to the normal one, the information disappears.
- AWRR ALM LO: to adjust the lower alarm limit of AwRR. If the measuring value is smaller than the lower alarm limit of AwRR, “AWRR TOO LOW” appears on the screen. After the measuring value returns to the normal one, the information disappears.
- APNEA ALM: After selecting the alarm time for APNEA alarm (having 7 levels, which are 10S, 15S, 20S, 25S, 30S, 35S, and 40S), the “CO₂ APNEA” information will appear on the screen after the corresponding selected time. The alarm level is HIGH.
- SWEEP: to adjust the display rate of CO₂ waveforms with “6.25 mm/s”, “12.5 mm/s”, or “25.0 mm/s” selectable.
- UNIT: to change the display units of CO₂ and InsCO₂ parameters. “mmHg” and “kPa” are available for selection.
- Exit: to close CO₂ SETUP menu.

Note

-
- “APNEA ALM” cannot be closed.
-
- OTHER SET: pick this item in the menu to call up CO₂ more setup sub-menu.



Figure 16-5 CO₂ More Setups Menu

Now we introduce you to the functions of each item in CO₂ SETUP submenu.

- **WAVE SCALE:** to adjust full scale size of CO₂ waveform display area with “LO” or “HI” selectable. The default value is “LO”.
- **WORK MODE:** in the MainStream measurement ,you must set the work mode to " MEASUREMENT".
- **ATMOS:**This setting is used to set current Barometric Pressure.
Resolution:1 mmHg(400mmHg~850mmHg), Default:760mmHg.
- **O2 COMPENSATE:**Use this setting to correct for the compensation of the gas mixture administered to the patient.
Resolution:1%(0~100%), Default:16%.
- **BALANCE GAS:** Use this setting to correct for the compensation of the gas mixture administered to the patient.
"room air", "N₂O", "Helium" Will be selected. Default:"room air".
- **ANEA:** Use this setting to correct for the compensation of the gas mixture administered to patient.
Resolution:0.1%(0.0~20.0%), Default:0.0%.

Note

- **Anesthetic agent is ignored when the balance gas is set to helium.**
- Zero: A “Sample Cell Zero “is a quick process that allows the module to accommodate the optical characteristics of each of the different adapter type ..A Sample Cell Zero should be performed whenever the type of adapter being used with the module is changed. For optimal accuracy , a Sample Cell Zero should also be performed whenever the module is connected to the host system.

Note

- **No routine calibration required.An airway adapter zero is required when changing to a different style of airway adapter.**
- To perform a Sample Cell Zero:
 1. Set the Host to the zeroing function.
 2. Connect the CO₂ Module and, if necessary, wait for the sensor warm-up message to clear.
 3. Connect a Sampling accessory to the module ,and make certain that the accessory is exposed to room air and away from all sources of CO₂,including the ventilator ,the patient’s breath and your own.
 4. Start the Sample Cell Zero .The maximum time is 40 seconds .The typical time for a zero is 15-20 seconds.
- **When not using CO₂ monitoring function, it is suggested that the “ WORK MODE” should be adjusted to “STANDBY” .**
- **DEFAULT:** pick this item to access the CO₂ DEFAULT CONFIG dialog box, in which the user may select whether the FACTORY DEFAULT CONFIG or the USER DEFAULT CONFIG is to be used. After selecting any of the items and exiting the dialog box, the system will pop up the dialog box asking for the user’s confirmation.

EtCO₂ upper alarm limit: when parameter value exceeds this limit, there will be alarm for exceeding the upper limit.

Default:
 Adult: 50 mmHg
 Pediatric: 50 mmHg
 Neonatal: 45 mmHg

EtCO₂ lower alarm limit: when parameter value is smaller than the lower limit, there will be alarm for exceeding lower limit.

Default:
 Adult: 15 mmHg

Pediatric: 20 mmHg
 Neonatal: 30 mmHg
 InsCO₂ upper alarm limit: when parameter value exceeds this limit, there will be alarm for exceeding upper limit.
 Default:
 Adult: 4 mmHg
 Pediatric: 4 mmHg
 Neonatal: 4 mmHg
 AwRR upper alarm limit: when parameter value exceeds this limit, there will be alarm for exceeding upper limit.
 Default:
 Adult: 30 rpm
 Pediatric: 30 rpm
 Neonatal: 100 rpm
 AwRR lower alarm limit: when parameter value is smaller than the limit, there will be alarm for exceeding lower limit.
 Default:
 Adult: 8 rpm
 Pediatric: 8 rpm
 Neonatal: 30 rpm
 APNEA Time: Selections are 10S to 40S,
 Default: 20S.
 Work Mode: Standby, Measurement.
 Unit: mmHg/kPa.
 Default: mmHg
 Waveform Sweep: 25.0/12.5/6.25 (mm/s)
 Default: 25.0 mm/s
 Waveform Scale: LOW/HIGH
 Default: LOW

Besides, for alarm function of CO₂ module, refer to Chapter Alarm, for its recording function, refer to Chapter Recording, and for information about alarm event review, graphic and tabular trend of CO₂ parameters, refer to Chapter Trend and Event.

16.4 Alarm Information and Prompt

Among physiological alarms, those belonging to the type that the parameter has exceeded the limits may activate the recorder to automatically output the parameters and related measured waveforms when the alarms occur on the condition that the alarm record switch in the related menu is On.

Tables below describe the possible physiological alarms, technical alarms and prompt messages occurring during CO₂ measurement.

Physiological alarms:

Message	Cause	Alarm Level
CO ₂ TOO HIGH	EtCO ₂ measuring value is above upper alarm limit.	User-selectable
CO ₂ TOO LOW	EtCO ₂ measuring value is below lower alarm limit.	User-selectable
INS TOO HIGH	InsCO ₂ measuring value is above alarm limits.	User-selectable
AWRR TOO HIGH	AwRR measuring value is above upper alarm limit.	User-selectable
AWRR TOO LOW	AwRR measuring value is below lower alarm limit.	User-selectable
CO ₂ APNEA	In specific time interval, no RESP can be detected using CO ₂ module.	HIGH

Technical alarms:

Message	Cause	Alarm Level	Remedy
CO ₂ Sensor Faulty	The Sensor Source Current Failure	HIGH	Check that the sensor is properly plugged in. Reinsert or reseal the sensor if necessary. If error persists, return sensor to factory for servicing.
CO ₂ Sensor Over temp	The sensor temperature is greater than 40°C	HIGH	Make sure sensor is not exposed to extreme heat. If error persists, return sensor to factory for servicing.

CO ₂ Check Sampling Line	This error occurs whenever the pneumatic pressure is outside the expected rang	LOW	Check that the sampling line is not occluded or kinked.
CO ₂ Zero Error	An error was found during Zero	LOW	To clear, check airway adapter and clean if necessary. If this does not correct the error, perform an adapter zero.
CO ₂ Out of Range	The value being calculated is greater than the upper CO ₂ limit.	LOW	If error persists, perform a zero.
CO ₂ Check Airway Adapter	Usually caused when the airway adapter is removed from the sensor or when there is an optical blockage on the windows of the airway adapter. May also be caused by failure to perform Zero to When adapter type is changed.	LOW	To clear, clean airway adapter if mucus or moisture is seen. If the adapter is clean, perform a Zero.
CO ₂ not initialized	Barometric Pressure or gas compensations have not been set since power on.	LOW	Set the Barometric Pressure and gas compensations to clear this error.

Prompt message:

Message	Cause	Alarm Level
CO ₂ Zero in Progress	A Zero is currently in progress	No alarm
CO ₂ Sensor Warm Up	Shows that the sensor is in warming-up stage.	No alarm
CO ₂ Check Adapter		No alarm
CO ₂ Zero Required		No alarm
CO ₂ Sample Line Disconnected	This is no sidestream sampling set connected to the CO ₂ sensor	No alarm

16.5 Maintenance and Cleaning

Care and Maintenance

1. Sample line is for one-off use in SideStream module.Do not sterilize or clean for reuse on another patient.
2. Airway adapter is for one-off use in MainStream module..Do not sterilize or clean for reuse on another patient.
3. When the sample system of SideStream module occurring occlusion,first check kinks for sampling line.If no kinks are found,then check water trap after disconnecting sample line from the Watertrap.If the occlusion message on the screen disappears,the sampling line must be replaced.If the occlusion message on the screen remains,the Watertrap must be replaced.
4. No routine calibration required in both MainStream and SideStream CO₂ module.

Chapter17 Accessories and Ordering Information

This chapter lists the recommendation accessories used in this device.



Warning

- The accessories list below are specified to be used in this device of our company. The device will be possibly damaged or lead some harm if any other accessories are used.

17.1 ECG Accessories

Part Number	Accessories	Type	Remark
1.4.07.00002	ECG electrodes, adult, 20 pieces	Disposable	/
1.4.07.00003	ECG electrodes, child, 20 pieces		
2.3.04.00213	Integrated 5-lead, type B, AHA, TPU, snap	Reusable	/
2.3.04.00214	Integrated 5-lead, type B, ICU, TPU, snap		
2.3.04.00240	Integrated 5-lead, type B, AHA, Defib, PVC, snap		
2.3.04.00241	Integrated 5-lead, type B, ICU, Defib, PVC, snap		
2.3.04.00211	Integrated 5-lead, type B, AHA, PVC, child, clip		
2.3.04.00212	Integrated 5-lead, type B, ICU, PVC, child, clip		
2.3.04.00225	Integrated 3-lead, type B, AHA, PVC, snap		
2.3.04.00226	Integrated 3-lead, type B, ICU, PVC, snap		
2.3.04.00227	Integrated 3-lead, type B, AHA, PVC, child, clip		
2.3.04.00228	Integrated 3-lead, type B, ICU, PVC, child, clip		

17.2 SpO₂ Accessories

Part Number	Accessories	Type	Remark
2.3.08.00004	Digital 5-pin adult finger-clip SpO ₂ sensor (3M)	Reusable	/
2.3.08.00007	Digital 5-pin child finger-clip SpO ₂ sensor (3M)		
2.3.08.00020	Digital 5-pin adult fingertip SpO ₂ sensor (3M)		
2.3.08.00025	Digital 5-pin old fashion adult finger-clip SpO ₂ sensor (3M)		
2.3.09.00001	Digital SpO ₂ extension cable (2M)		
2.3.08.00003	Digital DB7 adult finger-clip SpO ₂ sensor (1M)	Reusable (equipped with extension cable)	
2.3.08.00016	Digital DB7 child finger-clip SpO ₂ sensor (1M)		
2.3.08.00017	Digital DB7 adult fingertip SpO ₂ sensor (1M)		
2.3.08.00029	Digital DB7 adult integrated bundled SpO ₂ sensor (1M)		

17.3 NIBP Accessories

Part Number	Accessories	Type	Remark
2.3.11.00001	Neonate capsule single tube repeatable cuff (6-11CM)	Reusable	/
2.3.11.00002	Infant capsule single tube repeatable cuff (10-19CM)		
2.3.11.00003	Child capsule single tube repeatable cuff (18-26C)		
2.3.11.00004	Adult capsule single tube repeatable cuff (25-35C)		
2.3.11.00005	Adult Plus capsule single tube repeatable cuff (33-47CM)		
2.3.11.00006	Adult leg capsule single tube repeatable cuff (46-66CM)		
2.3.11.00007	NIBP extension tube, 85A Grey, TPU, quick connector (negative) at both ends		

17.4 TEMP Accessories

Part Number	Accessories	Type	Remark
2.3.06.00001	R25=2.252K TEMP probe, skin type, 6.3 single positive, PVC, L=3M	Reusable	/
2.3.06.00002	R25=2.252K TEMP probe, intracavitary type, 6.3 single positive, PVC, L=3M		
2.3.06.00017	R25=2.252K TEMP probe, skin type, 6.3 single positive, PVC, L=3M		
2.3.06.00018	R25=2.252K TEMP probe, intracavitary type, 6.3 single positive, PVC, L=3M		

17.5 IBP Accessories

Part Number	Accessories	Type	Remark
2.3.02.00001	IBP integrated module	Reusable	Ancillary use
2.3.07.00026	Spacelabs and ABBOTT Transducer Adapter Cable		
1.4.11.00007	IBP sensor/PT-01	Disposable	

17.6 CO₂ Accessories

CO₂ Module

Part Number	Accessories	Type	Remark
2.3.02.00031	CO ₂ module/CO ₂ -M02, mainstream	Reusable	/
2.3.02.00068	CO ₂ module/CO ₂ -M01, sidestream , Green,		
2.3.02.00069	CO ₂ module/import sidestream (1022054), Green		
2.3.02.00070	CO ₂ module/import mainstream (1015928) Green,		
2.3.02.00072	CO ₂ module/home mainstream (C500), Green,		
1.4.11.00019	Single patient use adult airway adapter Mainstream / P/N-6063-00	Disposable	Mainstream
1.4.11.00020	Single patient use neonatal airway adapter Mainstream / P/N-6312-00		
1.4.11.00006	Adult nasal sampling cannula / 3468ADU-00	Disposable	Sidestream
1.4.11.00013	Pediatric/Adult airway adapter kit /3472ADU-00		

1.4.11.00014	Pediatric/Adult airway adapter kit with dehumidification tubing / 3473ADU-00		
1.4.11.00021	Pediatric nasal sampling cannula / 3468PED-00		
1.4.11.00022	Infant nasal sampling cannula / 3468INF-00		
1.4.11.00024	Adult nasal sampling cannula with dehumidification tubing / DM-3100-LT	Disposable	Mainstream
1.4.11.00025	Adult airway adapter kit with dehumidification tubing / DM7700-LT		

Chapter18 Default Settings Appendix

This appendix documents the most important default settings of your monitor as it is delivered from the factory. For a comprehensive list and explanation of default settings, see the Configuration Guide supplied with your monitor. The monitor's default settings can be permanently changed in Configuration Mode.

Note

- If your monitor has been ordered preconfigured to your requirements, the settings at delivery will be different from those listed here.

18.1 Country-Specific Default Settings

Certain default settings are specific to a particular country. These are listed here for all countries alphabetically.

Country-Description	Line Frequency	Units Weight	Units Height	ECG Cable Color
	50/60 [Hz]	kg, lb	in, cm	IEC, AAMI
Afghanistan	50	kg	cm	AAMI
Åland Islands	50	kg	cm	IEC
Albania	50	kg	cm	IEC
Algeria	50	kg	cm	IEC
American Samoa	60	lb	in	AAMI
Andorra	60	lb	in	AAMI
Angola	50	kg	cm	IEC
Anguilla	60	lb	in	AAMI
Antarctica	60	lb	in	AAMI
Antigua and Barbuda	50	kg	cm	AAMI
Argentina	50	kg	cm	AAMI
Armenia	50	kg	cm	IEC
Aruba	60	kg	cm	AAMI
Australia	50	kg	cm	AAMI
Austria	50	kg	cm	IEC
Azerbaijan	50	kg	cm	IEC
Bahamas, The	60	kg	cm	AAMI
Bahrain	50	kg	cm	AAMI
Bangladesh	60	lb	in	AAMI
Barbados	50	kg	cm	AAMI
Belarus	50	kg	cm	IEC
Belgium	50	kg	cm	IEC
Belize	60	lb	in	AAMI
Benin	60	lb	in	AAMI
Bermuda	60	kg	cm	AAMI
Bhutan	60	lb	in	AAMI
Bolivia	50	kg	cm	AAMI
Bosnia and Herzegovina	50	kg	cm	IEC
Botswana	50	kg	cm	IEC
Bouvet Island	60	lb	in	AAMI
Brazil	60	kg	cm	AAMI
British Indian Ocean Territory	60	lb	in	AAMI
Brunei Darussalam	50	kg	cm	AAMI
Brunei	50	kg	cm	IEC
Bulgaria	50	kg	cm	IEC
Burkina Faso	50	kg	cm	IEC
Burundi	50	kg	cm	IEC
Cambodia	50	kg	cm	IEC

Cameroon	50	kg	cm	IEC
Canada	60	kg	cm	AAMI
Cape Verde	60	lb	in	AAMI
Cayman Islands	60	kg	cm	AAMI
Central African Republic	50	kg	cm	IEC
Chad	60	lb	in	AAMI
Chile	50	kg	cm	AAMI
China	50	kg	cm	IEC
Christmas Islands	60	lb	in	AAMI
Cocos Keeling Islands	60	lb	in	AAMI
Colombia	60	kg	cm	AAMI
Comoros	60	lb	in	AAMI
Congo	50	kg	cm	IEC
Congo, Democratic Republic of the	50	kg	cm	IEC
Cook Islands	60	lb	in	AAMI
Costa Rica	60	kg	cm	AAMI
Côte d'Ivoire	50	kg	cm	IEC
Croatia	50	kg	cm	IEC
Cuba	60	kg	cm	IEC
Cyprus	50	kg	cm	IEC
Czech Republic	50	kg	cm	IEC
Denmark	60	lb	in	AAMI
Djibouti	50	kg	cm	IEC
Dominica	50	kg	cm	AAMI
Dominican Republic	60	kg	cm	AAMI
Ecuador	60	kg	cm	AAMI
Egypt	50	kg	cm	IEC
El Salvador	60	kg	cm	AAMI
Equatorial Guinea	50	kg	cm	IEC
Eritrea	50	kg	cm	IEC
Estonia	50	kg	cm	IEC
Ethiopia	50	kg	cm	IEC
Falkland Islands, Malvinas	60	lb	in	AAMI
Faroe Islands	60	lb	in	AAMI
Fiji	60	lb	in	AAMI
Finland	50	kg	cm	IEC
France	50	kg	cm	IEC
French Guiana	50	kg	cm	IEC
French Polynesia	60	lb	in	AAMI
French Southern Territories	60	lb	in	AAMI
Gabon	50	kg	cm	IEC
Gambia, The	50	kg	cm	IEC
Georgia	60	lb	in	AAMI
Germany	50	kg	cm	IEC
Ghana	50	kg	cm	IEC
Gibraltar	60	lb	in	AAMI
Greece	50	kg	cm	IEC
Greenland	60	lb	in	AAMI
Grenada	50	kg	cm	AAMI
Guadeloupe	50	kg	cm	IEC
Guam	60	lb	in	AAMI
Guatemala	60	kg	cm	AAMI
Guernsey	50	kg	cm	IEC
Guinea	60	lb	in	AAMI
Guinea-Bissau	60	lb	in	AAMI
Guyana	60	kg	cm	AAMI

Haiti	60	kg	cm	AAMI
Heard Island and McDonald Islands	60	lb	in	AAMI
Holy See, Vatican City State	60	lb	in	AAMI
Honduras	60	kg	cm	AAMI
Hong Kong	50	kg	cm	IEC
Hungary	50	kg	cm	IEC
Iceland	50	kg	cm	IEC
India	50	kg	cm	IEC
Indonesia	50	kg	cm	IEC
Iran, Islamic Republic of	50	kg	cm	AAMI
Iraq	50	kg	cm	AAMI
Ireland	50	kg	cm	IEC
Isle of Man	50	kg	cm	IEC
Israel	50	kg	cm	IEC
Italy	50	kg	cm	IEC
Jamaica	50	kg	cm	AAMI
Japan	60	kg	cm	IEC
Jersey	50	kg	cm	IEC
Jordan	50	kg	cm	AAMI
Kazakhstan	50	kg	cm	IEC
Kenya	50	kg	cm	IEC
Kiribati	60	lb	in	AAMI
Korea, Democratic People's Republic of	60	lb	in	AAMI
Korea, Republic of	60	kg	cm	AAMI
Kuweit	50	kg	cm	AAMI
Kyrgyzstan	60	lb	in	AAMI
Lao People's Democratic Republics	50	kg	cm	IEC
Latvia	50	kg	cm	IEC
Lebanon	50	kg	cm	AAMI
Lesotho	50	kg	cm	IEC
Liberia	50	kg	cm	IEC
Libyan Arab. Jamahiriya	60	lb	in	AAMI
Liechtenstein	60	lb	in	AAMI
Lithuania	50	kg	cm	IEC
Luxembourg	50	kg	cm	IEC
Macao	60	lb	in	AAMI
Macedonia, The former Yugoslav. Rep. of	50	kg	cm	IEC
Madagascar	50	kg	cm	IEC
Malawi	50	kg	cm	IEC
Malaysia	50	kg	cm	IEC
Maldives	60	lb	in	AAMI
Mali	50	kg	cm	IEC
Malta	50	kg	cm	IEC
Marshall Islands	60	lb	in	AAMI
Martinique	60	kg	cm	IEC
Mauritania	50	kg	cm	IEC
Mauritius	60	lb	in	AAMI
Mayotte	60	lb	in	AAMI
Mexico	60	kg	cm	AAMI
Micronesia, Fed. States of	60	lb	in	AAMI
Moldova, Republic of	60	lb	in	AAMI
Monaco	60	lb	in	AAMI
Mongolia	60	lb	in	AAMI
Montenegro	50	kg	cm	IEC
Montserrat	50	kg	cm	AAMI

Morocco	50	kg	cm	IEC
Mozambique	50	kg	cm	IEC
Myanmar	60	lb	in	AAMI
Namibia	50	kg	cm	IEC
Nauru	60	lb	in	AAMI
Nepal	60	lb	in	AAMI
Netherlands	50	kg	cm	IEC
Netherlands Antilles	50	kg	cm	AAMI
New Caledonia	60	lb	in	AAMI
New Zealand	50	kg	cm	AAMI
Nicaragua	60	kg	in	AAMI
Niger	50	kg	cm	IEC
Nigeria	50	kg	cm	IEC
Niue	60	lb	in	AAMI
Norfolk Islands	60	lb	in	AAMI
Northern Mariana Islands	60	lb	in	AAMI
Norway	50	kg	cm	IEC
Oman	50	kg	cm	AAMI
Pakistan	50	kg	cm	IEC
Palau	60	lb	in	AAMI
Palestinian Territory	50	kg	cm	AAMI
Panama	60	lb	in	AAMI
Papua New Guinea	60	lb	in	AAMI
Paraguay	50	kg	cm	AAMI
Peru	60	kg	cm	AAMI
Philippines	60	kg	cm	AAMI
Pitcairn	60	lb	in	AAMI
Poland	50	kg	cm	IEC
Portugal	50	kg	cm	IEC
Puerto Rico	60	lb	in	AAMI
Qatar	50	kg	cm	AAMI
Reunion	60	lb	in	AAMI
Romania	50	kg	cm	IEC
Russian Federation	50	kg	cm	IEC
Rwanda	50	kg	cm	IEC
Saint Helena	60	lb	in	AAMI
Saint Kitts and Nevis	60	kg	cm	AAMI
Saint Lucia	50	kg	cm	AAMI
Saint Pierre and Miquelon	60	lb	in	AAMI
Saint Vincent and the Grenadines	50	kg	cm	AAMI
Samoa	60	lb	in	AAMI
San Marino	60	lb	in	AAMI
Sao Tome and Principe	60	lb	in	AAMI
Saudi Arabia	50	kg	cm	AAMI
Senegal	50	kg	cm	IEC
Serbia	50	kg	cm	IEC
Serbia & Montenegro	50	kg	cm	IEC
Seychelles	60	lb	in	AAMI
Sierra Leone	50	kg	cm	IEC
Singapore	50	kg	cm	IEC
Slovakia	50	kg	cm	IEC
Slovenia	50	kg	cm	IEC
Solomon Islands	60	lb	in	AAMI
Somalia	50	kg	cm	IEC
South Africa	50	kg	cm	IEC

South Georgia and the South Sandwich Islands	60	lb	in	AAMI
Spain	50	kg	cm	IEC
Sri Lanka	60	lb	in	AAMI
Sudan	50	kg	cm	IEC
Suriname	60	kg	cm	AAMI
Svalbard and Jan Mayen	60	lb	in	AAMI
Swaziland	60	lb	in	AAMI
Sweden	50	kg	cm	IEC
Switzerland	50	kg	cm	IEC
Syrian Arab Rep	50	kg	cm	AAMI
Taiwan, Province of China	60	kg	cm	AAMI
Tajikistan	60	lb	in	AAMI
Tanzania, United Republic of	60	lb	in	AAMI
Thailand	50	kg	cm	AAMI
Timor-Leste	60	lb	in	AAMI
Togo	60	lb	in	AAMI
Tokelau	60	lb	in	AAMI
Tonga	60	lb	in	AAMI
Trinidad and Tobago	60	lb	in	AAMI
Tunisia	50	kg	cm	IEC
Turkey	50	kg	cm	IEC
Turkmenistan	60	lb	in	AAMI
Turks and Caicos Islands	60	kg	cm	AAMI
Tuvalu	60	lb	in	AAMI
Uganda	60	lb	in	AAMI
Ukraine	60	lb	in	AAMI
UK	50	kg	cm	IEC
United Arab Emirates	50	kg	cm	AAMI
United Kingdom	50	kg	cm	IEC
United States	60	lb	in	AAMI
United States Minor Outlying Islands	60	lb	in	AAMI
Uruguay	50	kg	cm	AAMI
Uzbekistan	60	lb	in	AAMI
Vanuatu	60	lb	in	AAMI
Venezuela	60	lb	in	AAMI
Viet Nam	50	kg	cm	IEC
Virgin Islands (British)	50	kg	cm	AAMI
Virgin Islands (US)	60	lb	in	AAMI
Wallis and Futuna Islands	60	lb	in	AAMI
Western Sahara	50	kg	cm	IEC
Yemen	50	kg	cm	AAMI
Zambia	60	lb	in	AAMI
Zimbabwe	60	lb	in	AAMI

18.2 Alarm and Measurement Default Settings

Settings are only entered once per table row if they are the same for all patient categories ¹.

18.2.1 Alarm Default Settings

Alarm Settings	Factory Default
ALARM VOL	1
ALM REC TIME	32 S
ALM PAUSE TIME	2 MIN
ALM TYPE	UNLATCH
KEYVOL	1

18.2.2 ECG, Arrhythmia, ST Default Settings

ECG Settings	Factory Defaults		
	Adult	Pedi	Neo
HR ALM	ON		
ALM LEV	MED		
ALM REC	OFF		
ALM HI	120 bpm	160 bpm	200 bpm
ALM LO	50 bpm	75 bpm	100 bpm
HR FROM	AUTO		
HR CHANNEL	CH1		
LEAD TYPE	5 LEADS		
SWEEP	25.0mm/s		

Arrhythmia Settings	Factory Defaults		
	Adult	Pedi	Neo
ARR ANAL	OFF		
PVCS ALM	OFF		
ALM LEV	MED		
ALM REC	OFF		
ALM HI	10		

Lead-independent ST Settings	Factory Defaults		
	Adult	Pedi	Neo
ST ANAL	OFF		
ST ALM	OFF		
ST ALM LEV	MED		
ST ALM SEC	OFF		
ST ALM HI	0.20		
ST ALM LO	-0.20		

18.2.3 Pulse Default Settings

Pulse Settings	Factory Defaults		
	Adult	Pedi	Neo
PR ALM	ON		
PR ALM HI	120 bpm	160 bpm	200 bpm
PR ALM LO	50 bpm	75 bpm	100 bpm
SWEEP	25mm/s		
AVG TIME	4S		

18.2.4 Respiration Default Settings

Respiration Settings	Factory Defaults		
	Adult	Pedi	Neo
ALM	ON		
ALM LEV	MED		
ALM REC	OFF		
ALM HI	30 rpm		100 rpm
ALM LO	8 rpm		30 rpm
SWEEP	25mm/s		
APENA ALM	20 s		
WAVE AMP	X1		

18.2.5 SpO₂ Default Settings

SpO ₂ Default Settings	Factory Defaults		
	Adult	Pediatric	Neonatal
SpO ₂ ALM	ON		
ALM LEV	HI		
SpO ₂ REC	OFF		
SpO ₂ ALM HI	100	100	95
SpO ₂ ALM LOW	90	90	80

18.2.6 NIBP Default Settings

NIBP Settings	Factory Defaults		
	Adult	Pedi	Neo
ALM	ON		
ALM LEV	MED		
ALM REC	OFF		
SYS ALM HI	160mmHg	120mmHg	90mmHg
SYS ALM LO	90mmHg	70mmHg	40mmHg
MEAN ALM HI	110mmHg	90mmHg	70mmHg
MEAN ALM LO	60mmHg	50mmHg	25mmHg
DIA ALM HI	90mmHg	70mmHg	60mmHg
DIA ALM LO	50mmHg	40mmHg	20mmHg
UNIT	mmHg		
INTERVAL	MANUAL		
INFLATION	150mmHg	100mmHg	70mmHg

18.2.7 Temperature Default Settings

Temp Settings	Factory Defaults		
	Adult	Pedi	Neo
ALM	ON		
ALM LEV	MED		
ALM REC	OFF		
T1 HI	39.0		
T1 LO	36.0		
T2 HI	39.0		
T2 LO	36.0		
TD	2.0		
UNIT	°C		

18.2.8 IBP Default Settings

IBP Settings	Factory Defaults		
	Adult	Pedi	Neo
ALM	ON		
ALM LEV	MED		
ALM REC	OFF		
SWEEP	25.0mm/s		
IBP1 UNIT	mmHg		
IBP2 UNIT	mmHg		

18.2.9 CO₂ Default Settings

CO ₂ Settings	Factory Defaults		
	Adult	Pedi	Neo
ALM	ON		
ALM LEV	MED		
ALM REC	OFF		
CO ₂ ALM HI	45		
CO ₂ ALM LO	30		
INS ALM HI	4		
AWRR ALM HI	100		
AWRR ALM LO	30		
APNEA ALM(S)	20		
SWEEP	25.0mm/s		
UNIT	mmHg		

Appendix I Product Specification

1 Classification

Anti-electroshock type	Class I equipment and internal powered equipment
EMC type	Class A
Anti-electroshock degree	ECG(RESP), SpO ₂ , NIBP, IBP,TEMP,CO ₂ CF
Harmful liquid proof degree	Ordinary equipment (sealed equipment without liquid proof)
Disinfection/sterilizing method	Refer to Chapter 11 ~ Chapter 16 for details.
Working system	Continuous running equipment

2 Specifications

2.1 Size and Weight

Size	Monitor	314 x 145 x 264 mm
Weight	Monitor	3.9 kg

2.2 Environment

Temperature		
	Working	+5°C ~ +40 °C
	Transport and Storage	-40°C ~ +55 °C
Humidity		
	Working	30% ~75%
	Transport and Storage	≤95 % (no coagulate)
Barometric		
	Working	700hPa ~ 1060hPa
	Transport and Storage	500hPa ~ 1060hPa
Power Supply		
		100-240V~ 50/60Hz
		Pmax=150VA
		FUSE T1.6AL250V

2.3 Display

Device	12.1 in. Color TFT, 3 LED Resolution:800*600
Messages	8 Waveforms Maximum 1 Alarm LED (Orange/Red) 1 Power LED (Green) 1 Battery Charge LED (Yellow) 3 Sound Mode corresponding Alarm Mode

2.4 Battery

Rechargeable 3500mAh 7.4V Li battery
 Operating time under the normal use and full charge greater than 90 minutes
 Operating time after the first alarm of low battery will be about 5 minutes
 Charging: up to 90% after charging 4 hours, fully charged after 5 hours

2.5 Recorder (Optional)

Record Width	48 mm
Paper Speed	25/50 mm/s
Trace	2
Recording types:	Continuous real-time recording 8 second real-time recording Auto 8 second recording Parameter alarm recording Waveform freeze recording Trend graph/table recording ARR events review recording Alarm event review recording NIBP review recording Drug Calculation and titration table recording

2.6 Recall

Trend Recall	
Short	1 hrs, 1 Second Resolution

Long 480 hrs, 1 Min. Resolution
 Alarm Event Recall
 71 alarm events of all parameters and 8/16/32seconds of corresponding waveform.
 NIBP Measurement Recall
 At least 4800 NIBP measurement data.
 SD card
 72 hrs ECG waveform
 TREND review

2.7 ECG

Lead Mode	5 Leads (R, L, F, N, C or RA, LA, LL, RL, V)
Lead selection	I, II, III, aVR, aVL, aVF, V,
Waveform	2 ch
Lead mode	3 Leads (R, L, F or RA, LA, LL)
Lead selection	I, II, III,
Waveform	1 ch
Gain	2.5mm/mV, 5.0mm/mV, 10mm/mV, 20mm/mV, 40mm/mV
Scan speed	12.5mm/s, 25mm/s, 50mm/s
HR	
Measure and Alarm Range	
Adult	15 ~ 300 bpm
Neonate/Pediatric	15 ~ 350 bpm
Accuracy	±1% or ±1bpm, which great
Resolution	1 bpm
Sensitivity	> 200 uV P-P
Differential Input Impedance	> 5 MΩ
CMRR	
Monitor	≥ 100dB
Operation	≥ 100 dB
Diagnosis	≥60dB
Electrode offset potential	±300mV
Leakage Current	< 10 μA
Baseline Recovery	≤ 5 s After Defi.
Input bias current (lead off detection)	≤ 0.1 μA (driver lead ≤ 1 μA)
ECG Signal Range	±8 mV (Vp-p)
Notch	50Hz/60Hz(Notch filter can be turned on or off manually)
Bandwidth	
Surgery	1 ~ 20 Hz(+0.4dB,-3dB)
Monitor	0.5Hz~40Hz(+0.4dB,-3dB)
Diagnostic	0.05Hz~75Hz(+0.4dB,-3dB);76Hz~150Hz(+0.4dB,-4.5dB)
Calibration Signal	1 mV (Vp-p), ±5% Accuracy
ST Segment Monitoring Range	
Measure and Alarm	-2.0 ~ +2.0 mV
Accuracy	-0.8 ~ +0.8mV ±0.04mV or ±10% which is greater
Other	unspecified
ARR Detecting	
Type	ASYSTOLE, VFIB/VTAC, COUPLET, BIGEMINY, TRIGEMINY, RONT, VT>2, PVC, TACHY, BRADY, MISSED BEATS, PNP, PNC
Alarm	Available
Review	Available
Tall T-wave rejection capability	1.2mV
Heart rate averaging	the average value of the latest 6 R-R intervals which have ignored the maximum and minimum
Updating rate of the display	1s
Heart rate meter accuracy and response to irregular rhythm:	
Bigeminy ventricular	80±1bpm
Bigeminy ventricular alternative lente	60±1bpm
Bigeminy ventricular alternative rapid	120±1bpm
Systoles bidirectional	90±1bpm
Response time to heart rate meter to change in heart rate	

80 to 120bpm < 8s
 80 to 40bpm < 8s

Time to ALARM for tachycardia

Tachycardia ventricular:amplitude =1mV(p-v),heart rate = 206bpm

Amplitude	Average(s)	Range (s)
×1	2.7	2.2~ 2.9
×0.5	3.8	3.5~4.0
×2	3.8	3.5~4.0

Tachycardia ventricular :amplitude =2mV(p-v),heart rate = 195bpm

Amplitude	Average(s)	Range (s)
×1	2.3	2.0~3.0
×0.5	3.3	3.0~4.0
×2	2.2	2.0~3.0

Pace Pulse

Pulse indicator	Pulse is marked if the requirements of ANSI/AAMI EC13:2002,Sect.4.1.4.1 are met: Amplitude: ±2mV ~ ±700mV Width: 0.1ms ~ 2ms
Pulse Rejection	Pulse is rejected if the requirements of ANSI/AAMI EC13-2002:Sect.4.1.4.1 are met: Amplitude: ±2mV ~ ±700mV Width: 0.1ms ~ 2ms

2.8 RESPIRATION

Method	Impedance between R-F(RA-LL)
Differential Input Impedance	>2.5 MΩ
Measuring Impedance Range:	0.3~5.0Ω
Base line Impedance Range:	0.1 KΩ– 2.5 KΩ
Bandwidth	0.3 ~ 2.5 Hz
Scan speed	6.25mm/s, 12.5mm/s, 25mm/s
Resp Rate	
Measuring and Alarm Range	
Adult	0 ~ 120 rpm
Neonate/Pediatric	0 ~ 150 rpm
Resolution	1 rpm
Accuracy	±2 rpm
Apnea Alarm	10 ~ 40 s

2.9 NIBP

Method	Oscillometric
Mode	Manual, Auto, STAT
Measuring Interval in AUTO Mode	1, 2, 3, 4, 5, 10, 15, 30, 60, 90,120,240,480,960 Min
Measuring Period in STAT Mode	5 Min
Alarm Type	SYS, DIA, MEAN
Measuring and alarm Range	
Adult Mode	
SYS	40 ~ 270 mmHg
DIA	10 ~ 215 mmHg
MEAN	20 ~ 235 mmHg
Pediatric Mode	
SYS	40 ~ 200 mmHg
DIA	10 ~ 150 mmHg
MEAN	20 ~ 165 mmHg
Neonatal Mode	
SYS	40 ~ 135 mmHg
DIA	10 ~ 100 mmHg
MEAN	20 ~ 110 mmHg
Resolution	
Pressure	1mmHg
Accuracy	

Pressure		
Mean error		±5mmHg
Maximum Standard deviation		8mmHg
Software Overpressure Protection		
Adult Mode		297±3 mmHg
Pediatric Mode		240±3 mmHg
Neonatal Mode		147±3 mmHg
2.10 SpO₂		
Measuring Range		0 ~ 100%
Alarm Range		0 ~ 100 %
Resolution		1 %
Accuracy		70% ~ 100% ±2 % 0% ~ 69% unspecified
Actualization interval		about 1Sec.
Alarm Delay		10 Sec.
Scan speed		12.5mm/s, 25mm/s
Pulse Rate		
Measuring and Alarm Range		30~250bpm
Resolution		1bpm
Accuracy		±2bpm
2.11 TEMPERATURE		
Channel		2
Measuring and Alarm Range		0 ~ 50 °C
Resolution		0.1°C
Accuracy		±0.1°C
Actualization interval		about 1 Sec.
Average Time Constant		< 10 Sec.
2.12 IBP		
Channel		2
Label		ART, PA, CVP, RAP, LAP, ICP, P1, P2
Measuring and alarm range		-10~300mmHg
Press Sensor		
Sensitivity		5 uV/V/mmHg
Impedance		300-3000Ω
Resolution		1mmHg
Accuracy		±2% or 1mmHg which great
Actualization Interval		about 1 Sec
2.13 CO₂		
Method		Infra-red Absorption Technique
Measuring mode		MainStream and Sidestream
Side-stream mode sampling gas flow rate		50ml/Min±10ml/Min
Measuring range		
CO ₂		0~150mmHg
INSCO ₂		0~150mmHg
AwRR		2~150 BPM
Resolution		
CO ₂		0.1mmHg(0~69mmHg) 0.25mmHg(70~150mmHg)
INSCO ₂		0.1mmHg(0~69mmHg) 0.25mmHg(70~150mmHg)
Accuracy		
CO ₂		±2mmHg 0~40mmHg ±5% of reading 41~70mmHg ±8% of reading 71~100mmHg ±10% of reading 101~150mmHg
AwRR		±1 rpm

Initialization Time	Mainstream	Capnogram displayed in less than 15 seconds at an ambient temperature of 25°C, full specifications within 2 minutes.
	Sidestream	Capnogram displayed in less than 20 seconds at an ambient temperature of 25°C, full specifications within 2 minutes.
Mainstream Rise Time		Less than 60ms-Adult Reusable or Single-Patient-Use Airway Adapter Less than 60ms-Infant Reusable or Single-Patient-Use Airway Adapter
Actualization interval		about 1 Sec
Sidestream Delay Time:		2~3Sec
Alarm range		
	CO ₂	0~150 mmHg
	InsCO ₂	0~150 mmHg
	AwRR	2 ~ 150 BPM
Suffocation Alarm Delay		
	AwRR	10~60 Sec.

Appendix II System Alarm Prompt

PROMPT	CAUSE	MEASURE
"XX TOO HIGH"	XX value exceeds the higher alarm limit.	Check if the alarm limits are appropriate and the current situation of the patient.
"XX TOO LOW"	XX value is below the lower alarm limit.	
XX represents the value of parameter such as HR, ST1, ST2, RR, SpO ₂ , IBP, NIBP, etc in the system.		
"ECG WEAK SIGNAL"	The ECG signal of the patient is too small so that the system can not perform ECG analysis.	Check if the electrodes and lead wires are connected correctly and the current situation of the patient.
"NO PULSE"	The pulse signal of the patient is too small so that the system can not perform pulse analysis.	Check the connection of the sensor and the current situation of the patient.
"RESP APNEA"	The respiration signal of the patient is too small so that the system cannot perform RESP analysis.	Check the connection of the linking wire and the current situation of the patient.
"CO ₂ APNEA"	The respiration signal of the patient is too small so that the system cannot perform RESP analysis.	Check the connection of CO ₂ sensor and the current situation of the patient.
"ASYSTOLE"	Patient suffers from Arr. Of ASYSTOLE.	Check the current situation of the patient. Check the connection of the electrodes and lead wires.
"VFIB/VTAC"	Patient suffers from Arr. of VFIB/VTAC.	Check the current situation of the patient. Check the connection of the electrodes and lead wires.
"COUPLET"	Patient suffers from Arr. of COUPLET.	Check the current situation of the patient. Check the connection of the electrodes and lead wires.
"BIGEMINY"	Patient suffers from Arr. Of BIGEMINY.	Check the current situation of the patient. Check the connection of the electrodes and lead wires.
"TRIGEMINY"	Patient suffers from Arr. of TRIGEMINY.	Check the current situation of the patient. Check the connection of the electrodes and lead wires.
"R ON T"	Patient suffers from Arr. of R ON T.	Check the current situation of the patient. Check the connection of the electrodes and lead wires.
"PVC"	Patient suffers from Arr. of PVC.	Check the current situation of the patient. Check the connection of the electrodes and lead wires.
"TACHY"	Patient suffers from TACHY.	Check the current situation of the patient. Check the connection of the electrodes and lead wires.
" BRADY"	Patient suffers from BRADY.	Check the current situation of the patient. Check the connection of the electrodes and lead wires.
"VT>2"	Patient suffers from Arr. of VT>2.	Check the current situation of the patient. Check the connection of the electrodes and lead wires.
"MISSED BEATS"	Patient suffers from Arr. of MISSED BEATS.	Check the current situation of the patient. Check the connection of the electrodes and lead wires.
"PNP"	The pacemaker is not paced.	Check the connection of the pacemaker.

		Check the connection of electrodes and lead wires. Check the current situation of the patient.
"PNC"	No pacemaker signal is captured.	Check the connection of the pacemaker. Check the connection of electrodes and lead wires. Check the current situation of the patient.
"ECG LEAD OFF"	ECG lead is not connected correctly.	Check the connection of ECG lead wire.
"ECG V LEAD OFF";	The V lead wire of ECG is not connected correctly.	Check the connection of V lead wire.
"ECG LL LEAD OFF";	The LL lead wire of ECG is not connected correctly.	Check the connection of LL lead wire.
"ECG LA LEAD OFF";	The LA lead wire of ECG is not connected correctly.	Check the connection of LA lead wire.
"ECG RA LEAD OFF";	The RA lead wire of ECG is not connected correctly.	Check the connection of RA lead wire.
"ECG C LEAD OFF";	The C lead wire of ECG is not connected correctly.	Check the connection of C lead wire.
"ECG F LEAD OFF";	The F lead wire of ECG is not connected correctly.	Check the connection of F lead wire.
"ECG L LEAD OFF";	The L lead wire of ECG is not connected correctly.	Check the connection of L lead wire.
"ECG R LEAD OFF";	The R lead wire of ECG is not connected correctly.	Check the connection of R lead wire.
SpO ₂ SENSOR OFF	SpO ₂ sensor may be disconnected from the patient or the monitor.	Make sure that the monitor and the patient are in correct connection with the cables.
SpO ₂ INIT ERR	SpO ₂ module failure	Stop using the measuring function of SpO ₂ module, notify biomedical engineer or our service staff.
SpO ₂ INIT ERR 1		
SpO ₂ INIT ERR 2		
SpO ₂ INIT ERR 3		
SpO ₂ INIT ERR 4		
SpO ₂ INIT ERR 5		
SpO ₂ INIT ERR 6		
SpO ₂ INIT ERR 7		
SpO ₂ INIT ERR 8		
SpO ₂ COMM STOP	SpO ₂ module failure or communication error	Stop using the measuring function of SpO ₂ module, notify biomedical engineer or our service staff.
SpO ₂ COMM ERR	SpO ₂ module failure or communication error	Stop using the measuring function of SpO ₂ module, notify biomedical engineer or our service staff.
SpO ₂ ALM LMT ERR	Functional safety failure	Stop using the measuring function of SpO ₂ module, notify biomedical engineer or our service staff.
PR ALM LMT ERR	Functional safety failure	Stop using the measuring function of SpO ₂ module, notify biomedical engineer or our service staff.
Alarm information:		
SpO ₂ NO SENSOR	Sensor not fully inserted into the connector.	May be an incorrect sensor, or a defective sensor or cable. Insert sensor into the connector. Disconnect and reconnect sensor. Refer to the instructions for the sensor being used.

	Sensor inserted upside down.	Disconnect and reconnect the sensor with the logos matching.
SpO ₂ SENSOR OFF	SpO ₂ sensor may be disconnected from the patient or the monitor.	Disconnect and reconnect the sensor. Reattach sensor.
SpO ₂ SENSOR FAULT	This message appears when the sensor is faulty	Stop using the measuring function of SpO ₂ module, notify biomedical engineer or our service staff.
SpO ₂ UNRECOGNIZED SENSOR	board does not recognize the sensor.	Make sure that the monitor and the patient are in correct connection with the cables.
SpO ₂ INCOMPATIBLE SENSOR	This message is displayed when the sensor is finding incompatible sensor.	Make sure that the monitor use incompatible sensor.
SpO ₂ INTERFERENCE	Outside signal or energy preventing reading.	Remove outside interference.
SpO ₂ PULSE SEARCH	Unit is searching for the patients pulse.	If values are not displayed within 30 seconds, disconnect and reconnect sensor. If pulse search continues, remove sensor and replace on a better perfused site.
SpO ₂ LOW PERFUSION	Signal too small.	Move sensor to better perfused site.
SpO ₂ TOO MUCH LIGHT	Too much light on patient(sensor). Inadequate tissue covering sensor detector.	Remove or reduce lighting. Cover sensor from light. Reposition sensor.
SpO ₂ LOW SIGNAL IQ	Low signal quality.	Ensure proper sensor application. Mover sensor to a better perfused site.
SpO ₂ BOARD FAULT	This message appears when the Set board malfunctions.	Stop using the measuring function of SpO ₂ module, notify biomedical engineer or our service staff.
SpO ₂ COMMUNICATION ERROR	This message is displayed when the front end module is having problems communicating (ie: framing errors or bad checksums) with the board.	Stop using the measuring function of SpO ₂ module, notify biomedical engineer or our service staff.
SpO ₂ COMMUNICATION STOP	This message is displayed when the host can not receive the data from board for 5 seconds	Stop using the measuring function of SpO ₂ module, notify biomedical engineer or our service staff.
SpO ₂ INIT ERR	This message is displayed when the SpO ₂ module initialization error happened.	Stop using the measuring function of SpO ₂ module, notify biomedical engineer or our service staff.
"TEMP1 SENSOR OFF"	TEMP1 sensor is not connected correctly.	Check the connection of TEMP1 sensor.
"TEMP2 SENSOR OFF"	TEMP2 sensor is not connected correctly.	Check the connection of TEMP2 sensor.
"TEMP1 SENSOR OFF"	TEMP1 sensor is not connected correctly.	Check the connection of TEMP1 sensor.
"TEMP2 SENSOR OFF"	TEMP2 sensor is not connected correctly.	Check the connection of TEMP2 sensor.
"IBP1 LEAD OFF"	IBP1 sensor is not connected correctly.	Check the connection of IBP1 sensor.
"IBP2 LEAD OFF"	IBP2 sensor is not connected correctly.	Check the connection of IBP2 sensor.
"IBP1 NEED ZERO-CAL"	Zero calibrating must be done	Do zero calibrating for IBP1

	before measuring in IBP1	
"IBP2 NEED ZERO-CAL"	Zero calibrating must be done before measuring in IBP2	Do zero calibrating for IBP2
"TB SENSOR OFF"	TB sensor is not connected correctly.	Check the connection of TB sensor.
"ECG NOISE"	Rather large interference signals appear in the ECG signals.	Check the connection of ECG lead wire. Check the current situation of the patient. Check if the patient moves a lot.
"XX INIT ERR X"	XX has error X during initialization.	Re-start up the monitor or re-plug in/out the module. If the error still exists, contact the manufacturer.
"XX COMM STOP"	XX cannot communicate with the host.	
"XX COMM ERR"	XX cannot communicate normally with the host.	
XX represents all the parameter modules in the system such as ECG, NIBP, SpO ₂ , IBP module, etc.		
"XX ALM LMT ERR"	The alarm limit of XX parameter is modified by chance.	Contact the manufacturer for repair.
"XX RANGE EXCEEDED"	The measured value of XX parameter has exceeded the measuring range of the system.	Contact the manufacturer for repair.
XX represents the parameter name in the system such as HR, ST1, ST2, RR, SpO ₂ , IBP, NIBP, etc.		
"CO ₂ Sensor Faulty"	The Sensor Source Current Failure	Check that the sensor is properly plugged in. Reinsert or reseal the sensor if necessary. If error persists, return sensor to factory for servicing.
"CO ₂ Sensor Over temp"	The sensor temperature is greater than 40°C	Make sure sensor is not exposed to extreme heat. If error persists, return sensor to factory for servicing.
"CO ₂ Check Sampling Line"	This error occurs whenever the pneumatic pressure is outside the expected rang	Check that the sampling line is not occluded or kinked.
"CO ₂ Zero Error"	An error was found during Zero	To clear, check airway adapter and clean if necessary. If this does not correct the error, perform an adapter zero.
"CO ₂ Out of Range"	The value being calculated is greater than the upper CO ₂ limit.	If error persists, perform a zero.
"CO ₂ Check Airway Adapter"	Usually caused when the airway adapter is removed from the sensor or when there is an optical blockage on the windows of the airway adapter. May also be caused by failure to perform Zero to When adapter type is changed.	To clear, clean airway adapter if mucus or moisture is seen. If the adapter is clean, perform a Zero.
"CO ₂ not initialized"	Barometric Pressure or gas compensatins have not been set since power on.	Set the Barometric Pressure and gas compensations to clear this error.
"REAL CLOCK NEEDSET"	When the system displays 2000-1-1, the system gives this prompt reminding the user that the current system time is not right.	Re-set up the system time. It is better to set up the time just after the start-up and prior to monitoring the patient. After modifying the time, the user had better re-start up the monitor to avoid storing error time.
"REAL CLOCK NOT EXIST"	The system has no cell battery or the battery has run out of the capacity.	Install or replace the rechargeable battery.

"SYSTEM WD FAILURE"	The system has serious error.	Re-start up the system. If the failure still exists, contact the manufacturer.
"SYSTEM SOFTWARE ERR"		
"SYSTEM CMOS FULL"		
"SYSTEM CMOS ERR"		
"SYSTEM EPGA FAILURE"		
"SYSTEM FAILURE2"		
"SYSTEM FAILURE3"		
"SYSTEM FAILURE4"		
"SYSTEM FAILURE5"		
"SYSTEM FAILURE6"		
"SYSTEM FAILURE7"		
"SYSTEM FAILURE8"		
"SYSTEM FAILURE9"		
"SYSTEM FAILURE10"		
"SYSTEM FAILURE11"		
"SYSTEM FAILURE12"		
"KEYBOARD NOT AVAILABLE";	The keys on the keyboard cannot be used.	Check the keys to see whether it is pressed manually or by other object. If the key is not pressed abnormally, contact the manufacturer for repair.
"KEYBOARD COMM ERR";	The keyboard has failure, which cannot be used.	Contact the manufacturer for repair.
"KEYBOARD ERROR";		
"KEYBOARD ERR1";		
"KEYBOARD ERR2";		
"NET INIT ERR(G.)"	The network part in the system has failure. The system cannot be linked to the net.	Contact the manufacturer for repair.
"NET INIT ERR(Ram)"		
"NET INIT ERR(Reg)"		
"NET INIT ERR(Mii)"		
"NET INIT ERR(Loop)"		
"NET ERR(Run1)"		
"NET ERR(Run2)"		
"NET ERR(Run3)"		
"5V TOO HIGH"	The power part of the system has failure.	If the prompt appears repeatedly, contact the manufacturer for repair.
"5V TOO LOW"		
"POWER ERR3"		
"POWER ERR4"		
"12V TOO HIGH"		
"12V TOO LOW"		
"POWER ERR7"		
"POWER ERR8"		
"3.3V TOO HIGH"		
"3.3V TOO LOW"		
"CELL BAT TOO HIGH"	Cell battery has problem.	Replace the battery. If the failure still exists, contact the manufacturer.
"CELL BAT TOO LOW"	The cell battery has low capacity or the cell battery is not installed or the connection is loose.	
"RECORDER SELFTEST ERR"	During the selftest, the system fails connecting with the recorder module.	Execute 'Clear Record Task' function in the recorder setup menu to re-connect the host and the recorder. If the failure still exists, contact the manufacturer for repair.
"RECORDER VLT HIGH"	The recorder module has voltage failure.	Contact the manufacturer for repair.
"RECORDER VLT LOW"		

"RECORDER HEAD HOT"	The continuous recording time may be too long.	After the recorder becomes cool, use the recorder for output again. If the failure still exists, contact the manufacturer for repair.
"REC HEAD IN WRONG POSITION"	The handle for pressing the paper is not pressed down.	Press down the recorder handle for pressing the paper.
"RECORDER OUT OF PAPER"	No paper is in the recorder.	Place the paper into the recorder.
"RECORDER PAPER JAM"	The paper in the recorder is jammed.	Place the recorder correctly and try again.
"RECORDER COMM ERR"	The communication of the recorder is abnormal.	In the recorder setup menu, execute the function of clearing record task. The function can make the host and the recorder connect again. If the failure still exists, contact the manufacturer for repair.
"RECORDERS. COMM ERR"		
"RECORDER PAPER W.P."	The paper roll of the recorder is not placed in the correction position.	Place the paper roll in the correct position.
"REC NOT AVAILABLE"	Cannot communicate with the recorder.	In the recorder setup menu, execute the function of clearing record task. The function can make the host and the recorder connect again. If the failure still exists, contact the manufacturer for repair.
"NIBP INIT ERR"	NIBP initialization error	Execute the reset program in the NIBP menu. If the failure still exists, contact the manufacturer for repair.
"NIBP SELFTEST ERR"		
"NIBP ILLEGALLY RESET"	During NIBP measurement, illegal reset occurs.	Check the airway of NIBP to see if there are clogs. Then measure again, if the failure still exists, contact the manufacturer for repair.
"NIBP COMM ERR"	The NIBP communication part has problem.	Execute the reset program in the NIBP menu. If the failure still exists, contact the manufacturer for repair.
"LOOSE CUFF"	The NIBP cuff is not connected correctly.	Re-connect the NIBP cuff.
"AIR LEAK"	The NIBP cuff is not connected correctly or there are leaks in the airway.	Check the connection of each part or replace with a new cuff. If the failure still exists, contact the manufacturer for repair.
"AIR PRESSURE ERROR"	Problem happens when measuring the curve. The system cannot perform measurement, analysis or calculation.	Check the connection of each part or replace with a new cuff. If the failure still exists, contact the manufacturer for repair.
"WEAK SIGNAL"	Problem happens when measuring the curve. The system cannot perform measurement, analysis or calculation.	Check if the setup of patient type is correct. Check the connection of each part or replace with a new cuff. If the failure still exists, contact the manufacturer for repair
"RANGE EXCEEDED"	Problem happens when measuring the curve. The system cannot perform measurement, analysis or calculation.	Check the connection of each part or replace with a new cuff. If the failure still exists, contact the manufacturer for repair.
"EXCESSIVE MOTION"	The patient arm moves.	Check the connection of each part and the patient situation. Measure again, if the failure still exists, contact the manufacturer for repair.
"OVER PRESSURE"	Perhaps folds exist in the airway.	Check for the smoothness in the airway and patient situation. Measure

		again, if the failure still exists, contact the manufacturer for repair.
"SIGNAL SATURATED"	Problem happens when measuring the curve. The system cannot perform measurement, analysis or calculation.	Check the connection of each part and the patient situation. Measure again, if the failure still exists, contact the manufacturer for repair.
"NIBP TIME OUT"	Problem happens when measuring the curve. The system cannot perform measurement, analysis or calculation.	Check the connection of each part and the patient situation. Measure again, if the failure still exists, contact the manufacturer for repair.
"CUFF TYPE ERR"	Perhaps the used cuff does not fit the setup patient type.	Check if the patient type is set up correctly. Check the connection of each part or replace with a new cuff. If the failure still exists, contact the manufacturer for repair.
"PNEUMATIC LEAK"	NIBP airway has leaks.	Check the connection of each part or replace with a new cuff. If the failure still exists, contact the manufacturer for repair.
"MEASURE FAIL"	Problem happens when measuring the curve. The system cannot perform measurement, analysis or calculation.	Check the connection of each part and the patient situation. Measure again, if the failure still exists, contact the manufacturer for repair.
"NIBP SYSTEM FAILURE"	Problem happens when measuring the curve. The system cannot perform measurement, analysis or calculation.	Check the connection of each part and the patient situation. Measure again, if the failure still exists, contact the manufacturer for repair.

Appendix III
Guidance and manufacture's declaration-electromagnetic emission
for all EQUIPMENT and SYSTEMS

Guidance and manufacture's declaration –electromagnetic emission		
The <i>WE-9001 Patient Monitor</i> is intended for use in the electromagnetic environment specified below The customer of the user of the <i>WE-9001</i> should assure that it is used in such and environment.		
Emission test	compliance	Electromagnetic environment-guidance
RF emissions CISPR 11	Group 1	The <i>WE-9001 Patient Monitor</i> uses RF energy only for its internal function. Therefore, its RF emissions are very low and are not likely to cause any interference in nearby electronic equipment.
RF emissions CISPR 11	Class A	The <i>WE-9001 Patient Monitor</i> is suitable for use in all establishments, other than domestic establishments and those directly connected to the public low-voltage power supply network that supplies buildings used for domestic purposes.
Harmonic emissions IEC 61000-3-2	Class A	
Voltage fluctuations/ flicker emission IEC 61000-3-3	Complies	

**Guidance and manufacture's declaration-electromagnetic immunity-
for all EQUIPMENT and SYSTEMS**

Guidance and manufacture's declaration-electromagnetic immunity			
The <i>WE-9001 Patient Monitor</i> is intended for use in the electromagnetic environment specified below The customer or the user of <i>WE-9001 Patient Monitor</i> should assure that it is used in such an environment.			
Immunity test	IEC60601 test level	Compliance level	Electromagnetic environment-guidance
Electrostatic discharge (ESD) IEC 61000-4-2	±6kV contact ±8kV air	±6kV contact ±8kV air	Floors should be wood, concrete or ceramic tile. If floor are covered with synthetic material, the relative humidity should be at least 30%.
Electrical fast transient/burst IEC 61000-4-4	±2kV for power supply lines ±1kV for input /output signal	±0.5kV for power supply lines ± 1 kV for input /output signal	Mains power quality should be that of a typical commercial or hospital environment.
Surge IEC 61000-4-5	±1kV differential mode ±2kV common mode	±1kV differential mode ±2kV common mode	Mains power quality should be that of a typical commercial or hospital environment.
Power frequency (50/60Hz) magnetic field IEC 61000-4-8	3A/m	3A/m	Power frequency magnetic fields should be at levels characteristic of a typical location in a typical commercial or hospital environment
Voltage dips,short interruptions and voltage variations on power supply input lines IEC 61000-4-11	<5% U _T (>95% dip in U _T) for 0.5 cycle 40% U _T (60% dip in U _T) for 5 cycle 70% U _T (30% dip in U _T) for 25 cycle <5% U _T (>95% dip in U _T) for 5 sec	<5% U _T (>95% dip in U _T) for 0.5 cycle 40% U _T (60% dip in U _T) for 5 cycle 70% U _T (30% dip in U _T) for 25 cycle <5% U _T (>95% dip in U _T) for 5 sec	Mains power quality should be that of a typical commercial or hospital environment. If the user of the <i>WE-9001 Patient Monitor</i> requires continued operation during power mains interruptions, it is recommended that the <i>WE-9001 Patient Monitor</i> be powered from an uninterruptible power supply or a battery
NOTE U _T is the a.c. mains voltage prior to application of the test level.			

**Guidance and manufacture's declaration-electromagnetic immunity
for EQUIPMENT and SYSTEMS that are not LIFE-SUPPORTING**

Guidance and manufacture's declaration-electromagnetic immunity			
The <i>WE-9001 Patient Monitor</i> is intended for use in the electromagnetic environment specified below The customer or the user of <i>WE-9001 Patient Monitor</i> should assure that it is used in such an environment			
Immunity test	IEC60601 test level	Compliance level	Electromagnetic environment -guidance
<p>Conducted RF IEC61000-4-6</p> <p>Radiated RF IEC61000-4-3</p>	<p>3V_{rms} 150KHz to 80MHz</p> <p>3V/m 80MHz to 2.5GHz</p>	<p>1V_{rms}</p> <p>1V/m(80-800 MHz) 3V/m(800-250 0MHz)</p>	<p>Portable and mobile RF communications equipment should be used no closer to any part of the <i>WE-9001 Patient Monitor</i>, including cables, than the recommended separation distance calculated from the equation applicable to the frequency of the transmitter.</p> <p>Recommended separation distance</p> $d = 3.5\sqrt{P}$ $d = 3.5\sqrt{P} \text{ 80MHz to 800MHz}$ $d = 2.3\sqrt{P} \text{ 800MHz to 2.5GHz}$ <p>Where <i>P</i> is the maximum output power rating of the transmitter in watts (W) according to the transmitter manufacturer and <i>d</i> is the recommended separation distance in meters (m).</p> <p>Field strengths from fixed RF transmitters, as determined by an electromagnetic site survey, ^a should be less than the compliance level in each frequency range.^b</p> <p>Interference may occur in the vicinity of equipment marked with the following symbol:</p> 
NOTE 1 At 80MHz and 800 MHz, the higher frequency range applies.			
NOTE 2 These guidelines may not apply in all situations. Electromagnetic propagation is affected by absorption and reflection from structures, objects and people.			
^a Field strengths from fixed transmitters, such as base stations for radio (cellular/cordless) telephones and land mobile radios, amateur radio, AM and FM radio broadcast and TV broadcast cannot be predicted theoretically with accuracy. To assess the electromagnetic environment due to fixed RF transmitters, an electromagnetic site survey should be considered. If the measured field strength in the location in which the <i>WE-9001 Patient Monitor</i> is used exceeds the applicable RF compliance level above, the <i>WE-9001 Patient Monitor</i> should be observed to verify normal operation. If abnormal performance is observed, additional measures may be necessary, such as reorienting or relocating the <i>WE-9001 Patient Monitor</i> .			
^b Over the frequency range 150 KHz to 80 MHz, field strengths should be less than 1V/m(80-800MHz)&3V/m(800-2500MHz).			

Recommended separation distances between portable and mobile RF communications equipment and the EQUIPMENT or SYSTEM for EQUIPMENT or SYSTEM that are not LIFE-SUPPORTING

Recommended separation distances between portable and mobile RF communications equipment and the WE-9001 Patient Monitor			
The <i>WE-9001 Patient Monitor</i> is intended for use in the electromagnetic environment in which radiated RF disturbances are controlled. The customer or the user of the <i>WE-9001 Patient Monitor</i> can help prevent electromagnetic interference by maintaining a minimum distance between portable and mobile RF communications equipment (transmitters) and the <i>WE-9001 Patient Monitor</i> as recommended below according to the maximum output power of the communications equipment.			
Rated maximum output power of transmitter (W)	Separation distance according to frequency of transmitter (m)		
	150KHz to 80MHz $d = 3.5\sqrt{P}$	80MHz to 800MHz $d = 3.5\sqrt{P}$	800MHz to 2.5GHz $d = 2.3\sqrt{P}$
0.01	0.3500	0.3500	0.2334
0.1	1.1068	1.1068	0.7378
1	3.5000	3.5000	2.3334
10	11.0860	11.0860	7.3786
100	35.0000	35.0000	23.3334
For transmitters rated at a maximum output power not listed above, the recommended separation distanced in meters (m) can be estimated using the equation applicable to the frequency of the transmitter, where P is the maximum output power rating of the transmitter in watts (W) according to the transmitter manufacturer.			
NOTE 1 At 80MHz and 800MHz, the separation distance for the higher frequency range applies.			
NOTE 2 These guidelines may not apply in all situations. Electromagnetic propagation is affected by absorption and reflection from structures, objects and people.			

Appendix IV SpO₂ Clinical Information

Clinical Result information for each sensor

The table below shows ARMS values measured using SpO sensor (S5RCH300) with WE-9001 Patient Monitor in a clinical study.

Hemoximeter SaO ₂ Range			70-80	80-90	90-95	95-100	Total
Effective Count	Data Point		85	149	82	84	400
Exclusion Count	Data Point		89	156	91	97	433
Mean			0.01	0.19	0.17	-0.07	0.10
Standard Deviation			1.27	1.35	1.55	1.40	1.39
Upper/lower 95% limit			2.50/-4.27	2.85/-2.50	3.22/-2.88	2.68/-2.82	2.82/-2.63
Root Mean Square (RMS)			1.26	1.36	1.55	1.40	1.39

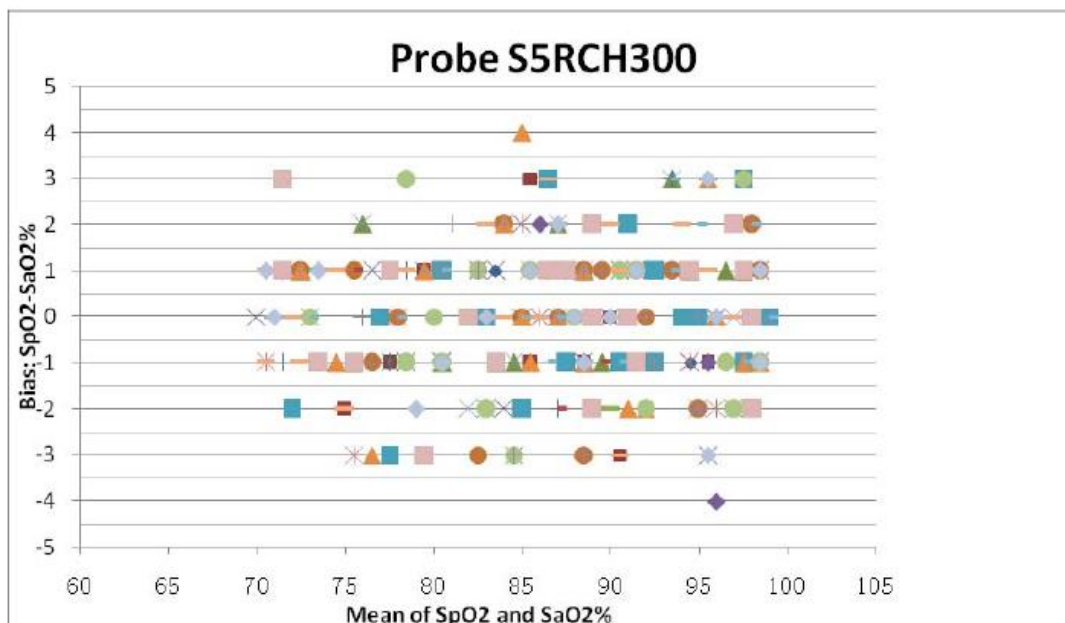

The table below shows ARMS values measured using SpO₂ sensor (S5RCS300) with WE-9001 Patient Monitor in a clinical study

Hemoximeter SaO ₂ Range			70-80	80-90	90-95	95-100	Total
Effective	Data	Point	83	151	84	82	400
Count							
Exclusion	Data	Point	92	159	86	87	424
Count							
Mean			0.29	0.07	0.57	-0.28	0.15
Standard Deviation			1.38	1.39	1.37	1.34	1.40
Upper/lower 95% limit			3.00/-2.42	2.80/-2.67	3.26/-2.12	2.34/-2.90	2.89/-2.60
Root Mean Square (RMS)			1.41	1.39	1.48	1.36	1.41

